

DC Fan



# 120x120x38 mm

San Ace 120 9G type

## General Specifications

- Material ..... Frame: Plastic (Flammability: UL 94V-0), Impeller: Plastic (Flammability: UL 94V-1)
- Expected life ..... See the table below. (L10 life: 90% survival rate for continuous operation in free air at 60°C, rated voltage)  
Expected life at 40°C is for reference only.
- Motor protection function ..... Locked rotor burnout protection, Reverse polarity protection  
For details, please refer to p. 599.
- Dielectric strength ..... 50/60 Hz, 500 VAC, for 1 minute (between lead wire conductors and frame)
- Insulation resistance ..... 10 MΩ or more with a 500 VDC megger (between lead wire conductors and frame)
- Sound pressure level (SPL) ..... At 1 m away from the air inlet
- Storage temperature ..... -30 to +70°C (Non-condensing)
- Lead wire ..... ⊕Red ⊖Black or Blue  Sensor Yellow
- Mass ..... 330 g

## Specifications

The models listed below **have ribs and pulse sensors**. For models without ribs, append "1" to the end of model numbers.

Model no.	Rated voltage [V]	Operating voltage range [V]	Rated current [A]	Rated input [W]	Rated speed [min <sup>-1</sup> ]	Max. airflow [m <sup>3</sup> /min] [CFM]	Max. static pressure [Pa] [inchH <sub>2</sub> O]	SPL [dB (A)]	Operating temperature [°C]	Expected life [h]
9G1212G101	12	10.2 to 13.8	0.98	11.76	3600	3.88 137	135 0.542	49	-20 to +70	40000/60°C (70000/40°C)
9G1212E101			0.61	7.32	3100	3.34 118	100 0.402	46		
9G1212H101		7 to 13.8	0.38	4.56	2600	2.8 99	70.4 0.283	39		
9G1212F101			0.28	3.36	2280	2.45 87	54.2 0.218	36		
9G1212M101			0.21	2.52	1950	2.1 74	39.6 0.159	32		
9G1224G101			24	20.4 to 27.6	0.5	12	3600	3.88 137		
9G1224E101	0.34	8.16			3100	3.34 118	100 0.402	46		
9G1224H101	14 to 27.6	0.22		5.28	2600	2.8 99	70.4 0.283	39		
9G1224F101		0.16		3.84	2280	2.45 87	54.2 0.218	36		
9G1224M101		0.11		2.64	1950	2.1 74	39.6 0.159	32		
9G1248G101		48		40.8 to 55.2	0.25	12	3600	3.88 137		
9G1248E101	0.17		8.16		3100	3.34 118	100 0.402	46		
9G1248H101	0.11		5.28		2600	2.8 99	70.4 0.283	39		
9G1248F101	0.09		4.32		2280	2.45 87	54.2 0.218	36		
9G1248M101	0.07		3.36		1950	2.1 74	39.6 0.159	32		

Note 1: Sensor and control options are available for selection. Refer to the table on pp. 627 to 628.  
 Note 2: The mark indicates Short Lead Time Service applicable models. See p. 654 for details.

## Airflow - Static Pressure Characteristics

**9G1212G101** With pulse sensor      **9G1212E101** With pulse sensor      **9G1212H101** With pulse sensor

Operating voltage range

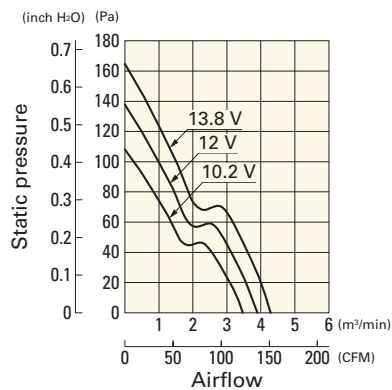

Operating voltage range

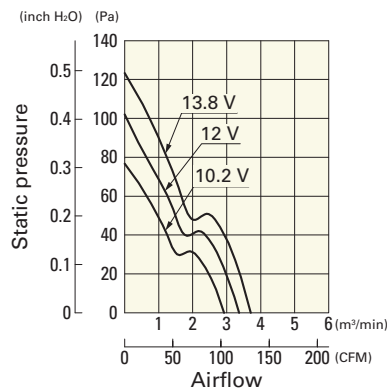

Operating voltage range

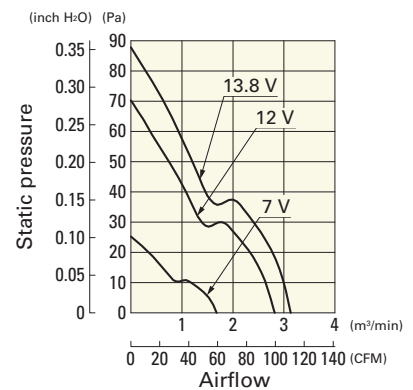

## Airflow - Static Pressure Characteristics

**9G1212F101** With pulse sensor

Operating voltage range

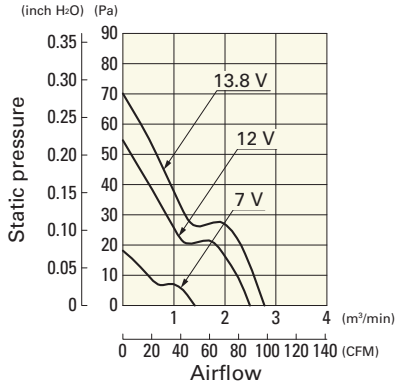

**9G1212M101** With pulse sensor

Operating voltage range

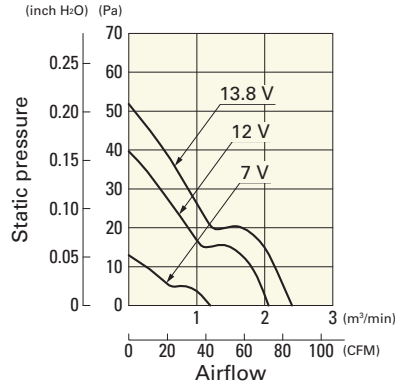

**9G1224G101** With pulse sensor

Operating voltage range

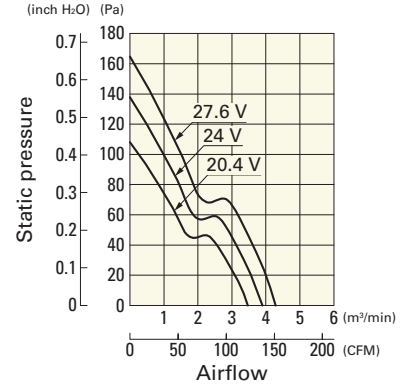

**9G1224E101** With pulse sensor

Operating voltage range

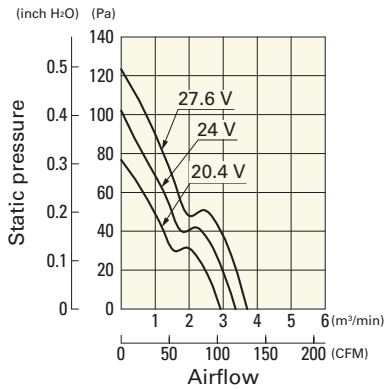

**9G1224H101** With pulse sensor

Operating voltage range

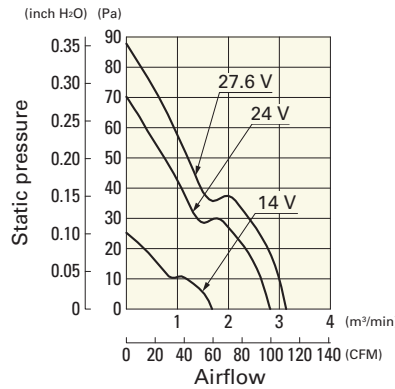

**9G1224F101** With pulse sensor

Operating voltage range

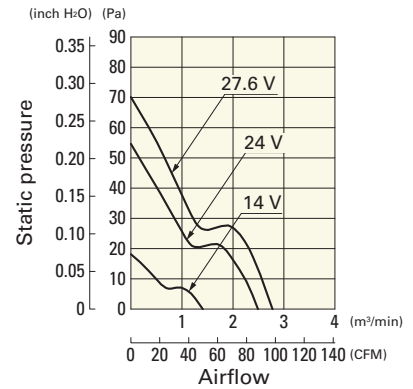

**9G1224M101** With pulse sensor

Operating voltage range

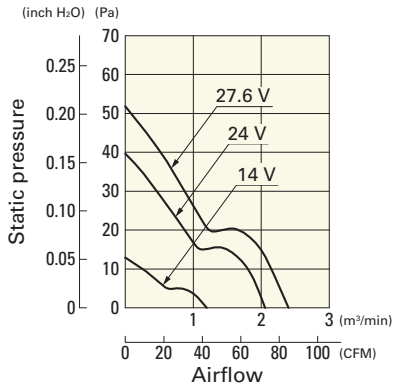

**9G1248G101** With pulse sensor

Operating voltage range

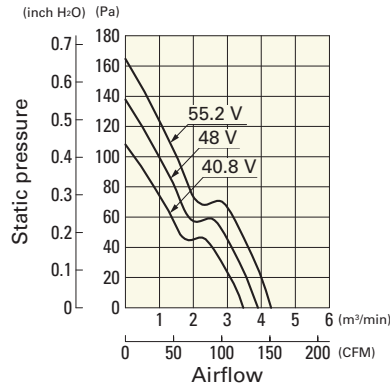

**9G1248E101** With pulse sensor

Operating voltage range

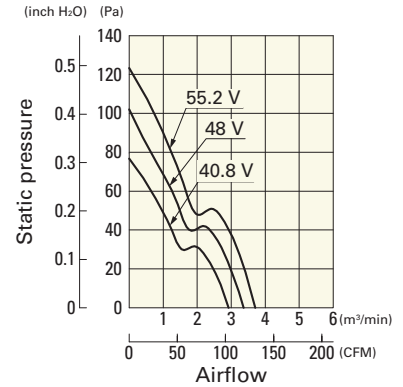

**9G1248H101** With pulse sensor

Operating voltage range

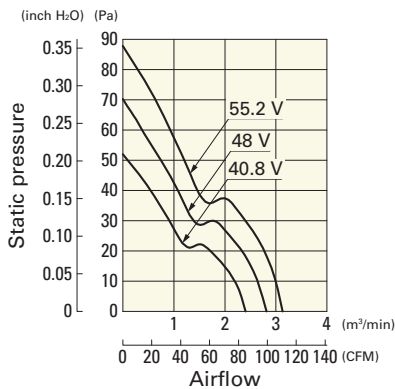

**9G1248F101** With pulse sensor

Operating voltage range

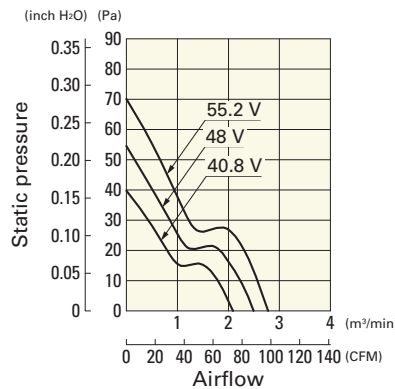

**9G1248M101** With pulse sensor

Operating voltage range

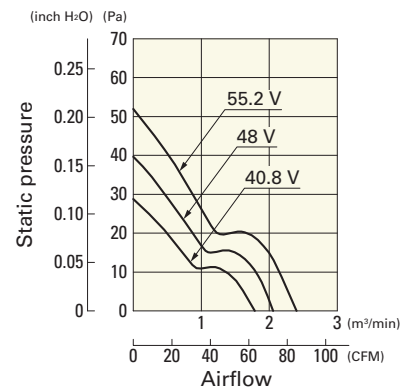

**Dimensions (unit: mm) (With ribs)**

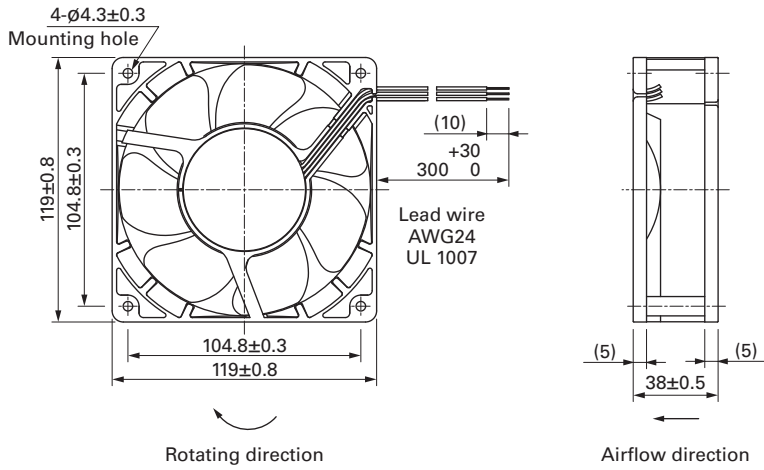

**Reference Dimensions of Mounting Holes and Vent Opening (unit: mm)**

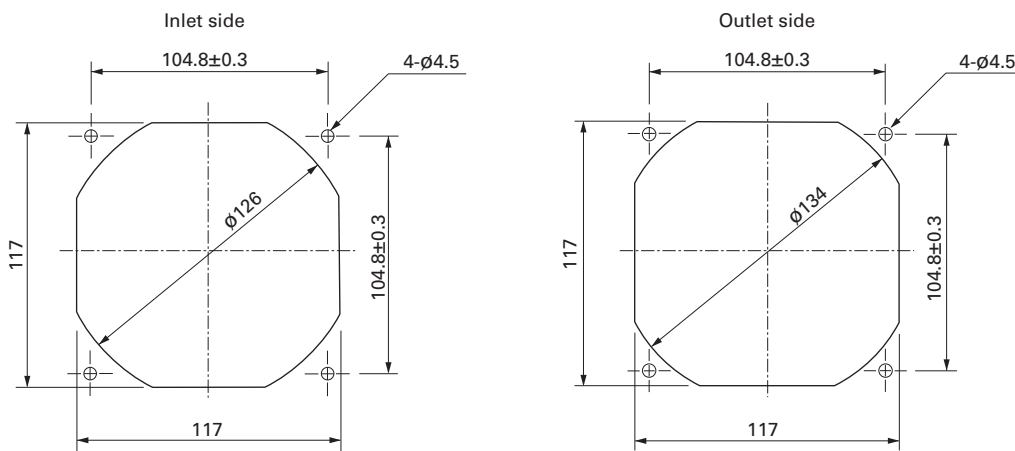

**Options**

**Finger guards**

page: p. 585

Model no.: 109-019E, 109-019K, 109-019C, 109-019H

**Resin finger guards**

page: p. 591

Model no.: 109-1000G

**Resin filter kits**

page: p. 592

Model no.: 109-1000F13 (13PPI), 109-1000F20 (20PPI),  
109-1000F30 (30PPI), 109-1000F40 (40PPI)