

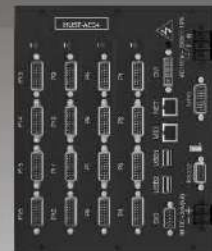

HUST CNC CONTROLLER

A Series universal controller



Rich interface for compact operation. Saves wiring intrusion controller

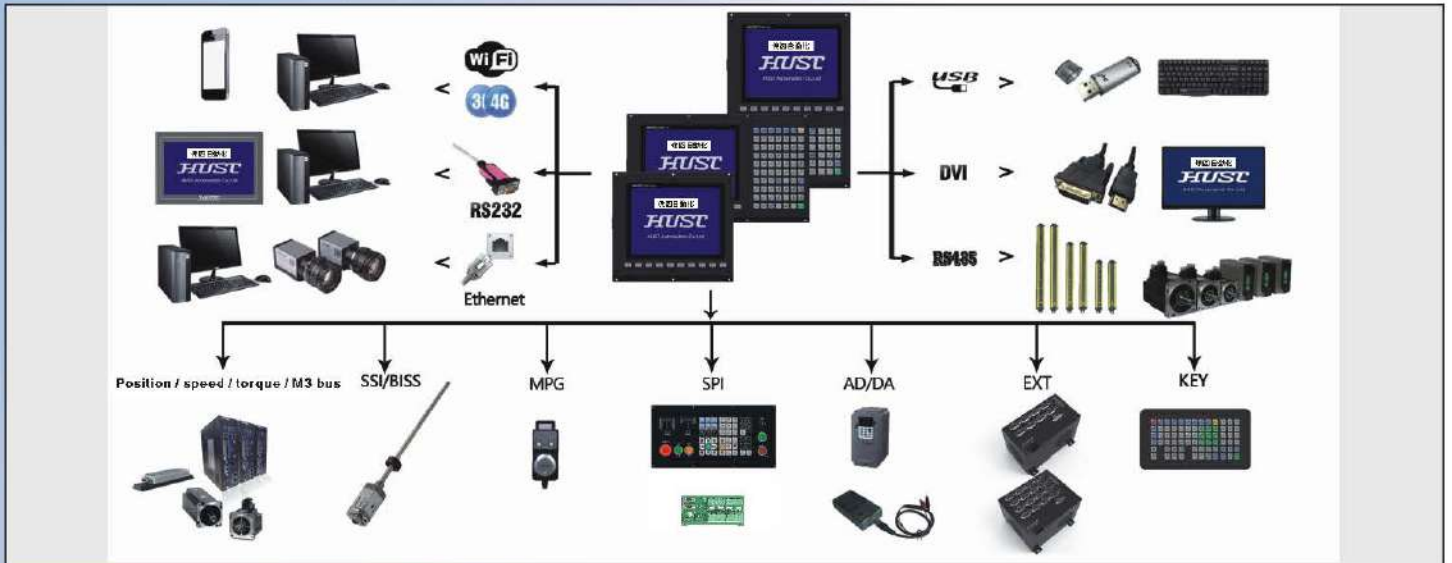

Performance Improvement

More standard

- International standard CNC programming specification
- International standard HMI language
- International standard peripheral communication module

More powerful

- CAD graphics plugin and CAM plugin function
- Open CNC customized design concept
- Adapt to multiple machine vision plugins

More mainstream

- RT Linux Intrusion Control System Platform
- Remote assistance troubleshooting
- Mobile APP Customized Configuration Monitoring
- Remote network system firmware upgrade

More widely used

- Support SSI/BISS absolute encoder
- Universal + CNC proprietary HMI function
- Bus axis and universal axis hybrid control

More efficient

- High-speed and high-precision MECHATROLINK-III bus
- 64 Bit high speed and high precision contour control
- PREFETCH 8000 blocks/sec
- Conversational auxiliary programming
- Maximum 12 channel combination technology
- High speed channel synchronization
- Modular software design
- Command online help

Axial expansion scheme

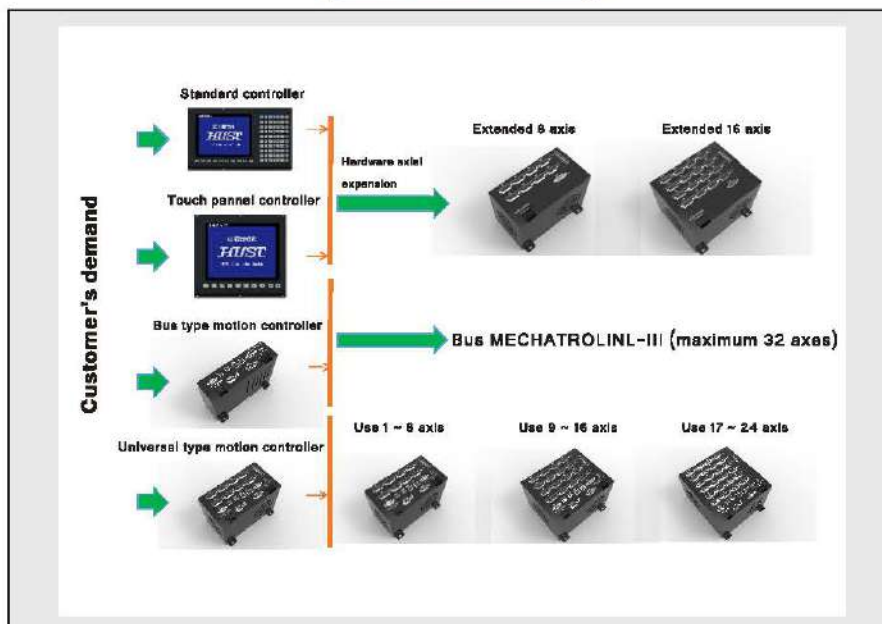

Multi-channel combination technology

- The maximum execution of 12 channels, each channel can independently run different CNC files. PLC.PID. Spindle, etc., can share a MHI operation, and can perform synchronization between channels. Wait. Data communication, greatly improve work efficiency, Reduce the Instability of external transmission media.

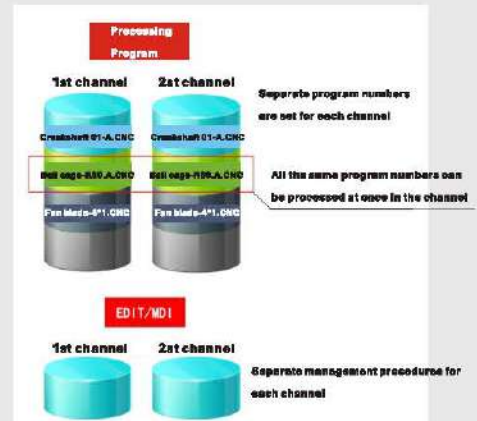
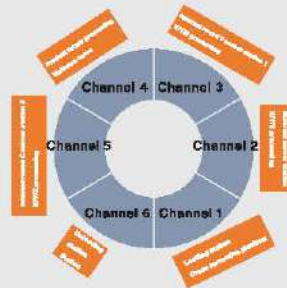
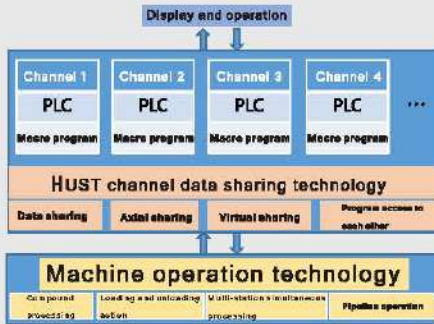

Coordinate system function

External coordinate system	External coordinate system	Local coordinate system	Tool length compensation	Tool wear compensation
G80 External Coordinate system	Up to 64 groups	G52 Local	Up to 160 groups	Up to 160 groups
	G54		T1	T1
	~		~	~
	G59		T160	T160
	~			
	G54.1 P1			
	~			
	G54.1 P48			

Position/speed/torque control

- With the three control modes of position, speed and torque, the real-time switching control mode can be realized in the process of motion control or stop state:
 1. Position Control-->Torque Control-->Position Control
 2. Speed Control -> Torque Control -> Speed Control
- Application Industry: powder molding machine (Inductor). Welder, etc.

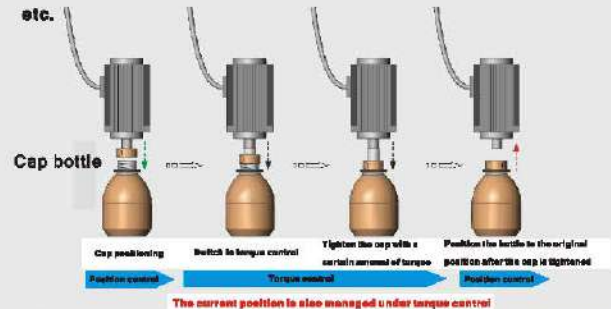

Inclined plane machining

- Tilting the workpiece due to mold or table unevenness, or directly planning the path on an inclined plane.
- According to the plane machining design program, the inclined plane can be completed by parameter setting the tilt angle, and the defects caused by the tilt on the machine assembly and the tilt caused by the workpiece clamping can be solved.



Electronic copying function

- Contour control of valve line axis and rotary axis interpolation by Cartesian coordinate system editing commands.
- It can directly import CAD drawings, automatically generate code through CAM plug-in, and introduce lead-out lines for automatic processing.
- Used in cam processing. Mobile glass edging. Contour welding. Edge sealing. Shoe mold grinding.

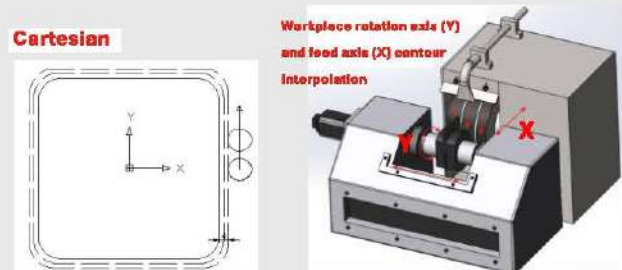

High speed and high precision motion control and positioning function

Synchronous control

- HUST controller replaces traditional mechanical cam to achieve multi-axis synchronization.
- The transmission is stable. The mechanical vibration is small. The noise is low. The service life is long.
- Widely used in round tool machine, chasing drill machine, labeling machine and other industries.

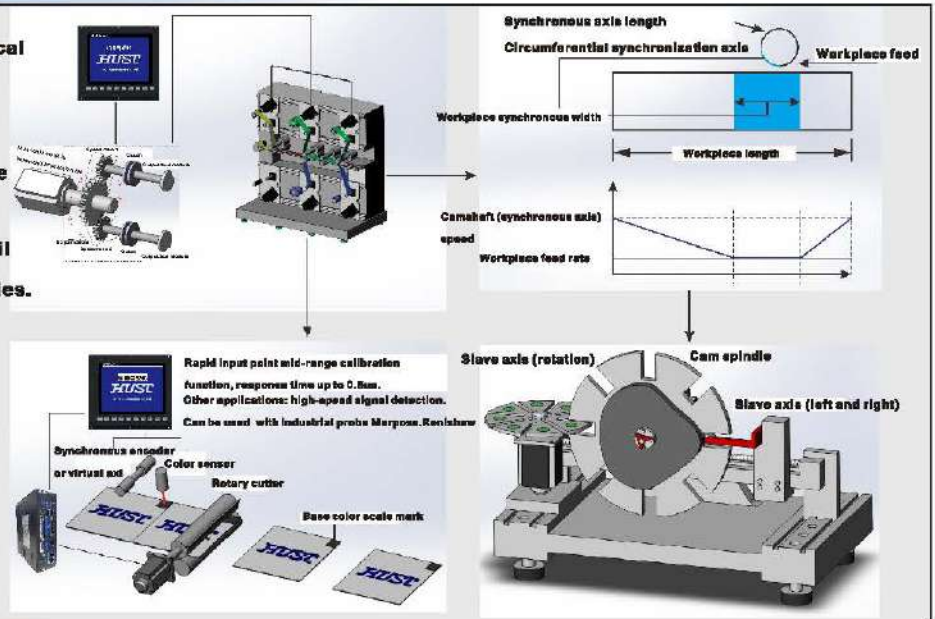

Winding control

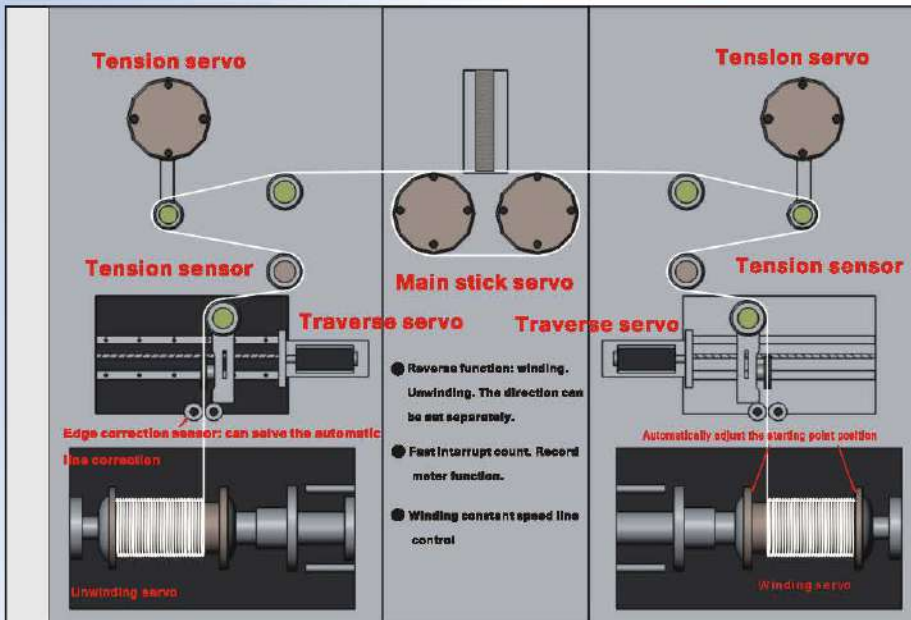

- Automatic winding compensation function: Eliminate the irregular shape of the I-shaped wheel or the deviation from the actual shape, resulting in the edge or groove at both ends of the cable. It can also solve the problem caused by the misalignment of the edge.



Convex



Concave groove

- HUST master tension control. Tension control of the slave axes according to the feedback of the tension sensor (potentiometer, encoder).
- It has high response and good stability. The tension control accuracy is less than 2g.
- Flexible parameters. Very adaptable to the machine.

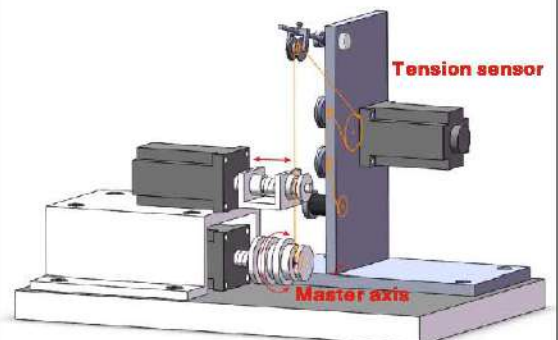
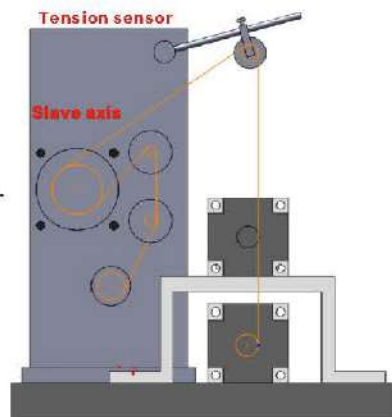

Open application module

- HUST controller has the function of expandable application software module, and expands the required application module in the form of plug-in according to the actual needs of customers.

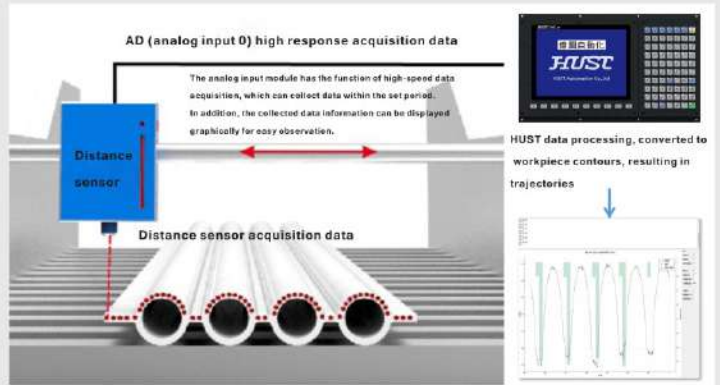

PWM input

- Support PWM5V.PWM24V control: 40MHz fundamental frequency. 12Bit resolution and 10KHz bandwidth, can be applied to energy control, combined with external magnetic grid (encoder) for closed loop control.
- Main applications: laser cutting energy control, proportional valve control, etc.

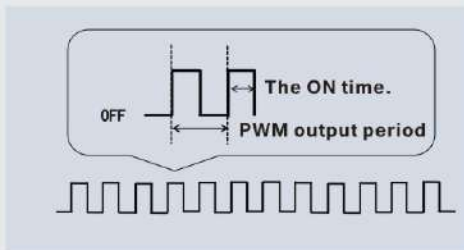

Absolute encoder communication

- Absolute position signal information can be obtained by absolute linear encoder with parallel or serial function to achieve high precision feedback control.
- Support format: SSI.BISS, etc.
- Application industry: leveling machine. Bending machine. Double-sided milling (rotary table). Automatic assembly line equipment.

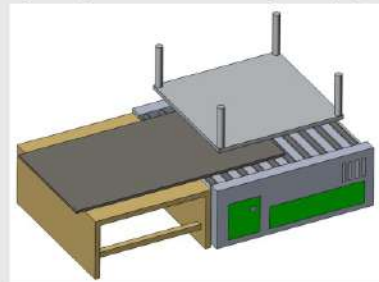

Three D display

- Display spatial graphics according to different needs, more figurative and vivid.
- Realize the conversion between 3D vector and Cartesian coordinate system.
- A variety of views are available for easy verification.
- Can be moved by the cursor. Rotate. Zoom in. Zoom out and other operations, should be sensitive.



Variable data collection display

- Simply set the parameters, collect the variable data, save it to the system or SD memory card, or save the data through Ethernet or USB. Analysis.
- Easily confirm small changes in the object variable data, easy troubleshooting, device adaptation.



Remote monitoring and management

- HUST products provide a complete CNC Internet of Things system, which enables on-site monitoring, connection management, interconnection with factory MES, and even remote WAN mobile APP monitoring, remote server monitoring and management, and remote after-sales service. , remote upgrade, provide solutions for remote troubleshooting.

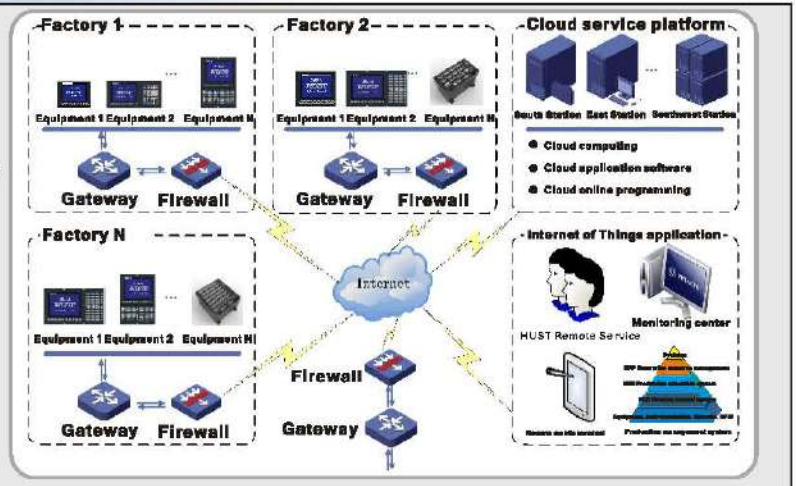

Bus control

Bus control

- MECHATROLINK-III communication protocol, the minimum transmission period is 31.25us, and the transmission rate is up to 100Mbps.
- The transmission is safe and reliable. It supports up to 32 servo serial or star-line connections. The connection distance is up to 100 meters. It can control 32 slaves in precise synchronization mode, and realize high-speed periodic communication required for motion control and large data communication.
- Online parameter reading and writing function: real-time monitoring or modification of the machining process to complete complex motion control
- Supports three control modes of position, speed and torque, and can realize online switching of three control modes.
- Allow bus servo and external encoder to form closed loop control.

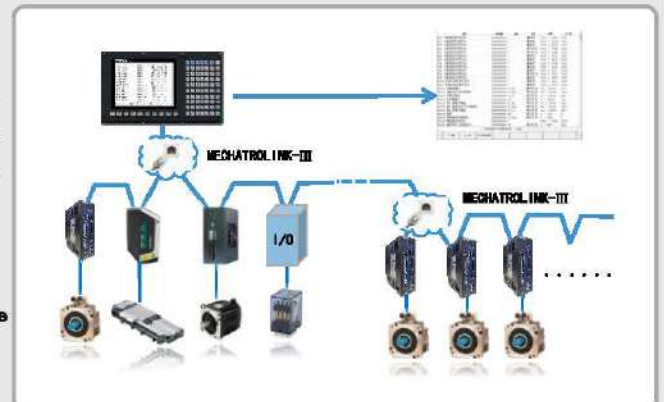

Mixing bus and universal axes

- The HUST controller supports the mixing of bus and universal axes. It supports up to 32 axes. Each axis can be independently set as a bus axis or universal axes.
- The universal axis controller has a calculation cycle of up to 0.5ms and can be used with a servo or stepper motor. The response speed is fast and the precision is high. The bus axis has the advantages of convenient wiring and online servo modification. The combination of the two can meet more complex process requirements.
- Customers are more flexible in motor selection, according to actual needs, more cost-effective.

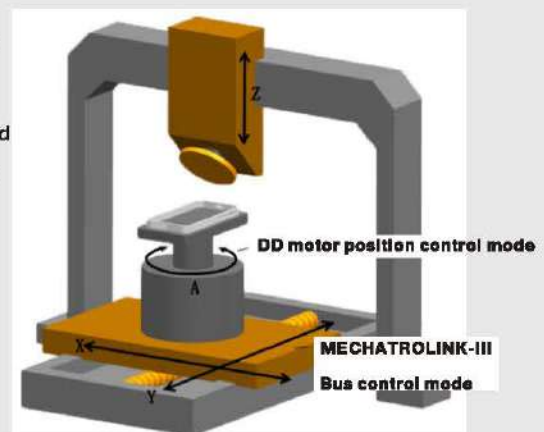

Perfect development platform

PC software solution

- Directly via WiFi or internet cable, according to the standard TCP protocol communication connection.
- Read in real time. Write variables or parameters to monitor controller status in real time.
- Provide the physical IP of the controller, realize software -to-controller binding, and encrypt the processing program.
- MDI.DNC.CNC is available in three ways, which is more flexible and convenient, and is suitable for different solutions.

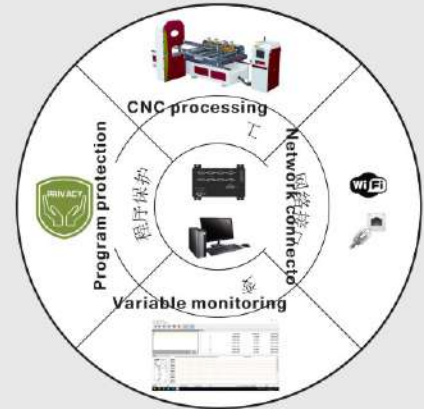

Open screen editing software - HMI

- Customized touch panel design, the best choice for automation equipment
- Enrich human-computer attributes and diversify visual effects
- Modular plug-in design, easy to learn
- Expandable plug-in technology makes mold configuration upgrade more convenient
- HMI.CNC.PLC. Execution on the same platform
- Internal macro editing, to achieve complex touch control functions
- Macro can be triggered by PLC.CNC, flexible development



Easy to use ladder diagram editing software - PLC

- Easy to use editing method
- Support data interaction between different channels
- Support call system internal modules, such as tool magazine module, electronic cam module, etc.
- Support for calling custom script modules
- Support multi-channel independent PLC operation

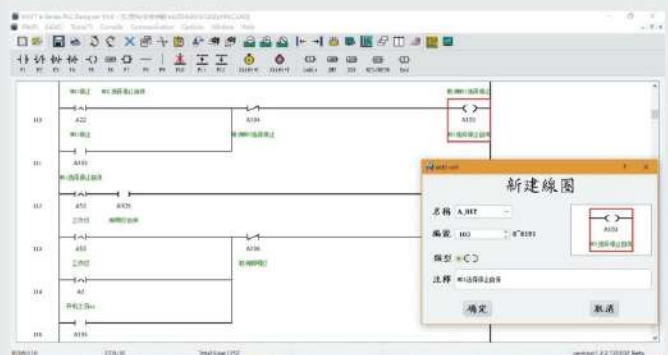

Open macro programming - MACRO

- Compatible with standard CNC MACRO calculations, and development of instruction redefinition, decimal point redefinition, making non-standard sports curriculum development more convenient.
- PTEFETCH and REALTIM instructions mixed programming mode, perfect solution to the shortcomings of CNC MACRO can not be implemented in real time

		Example
#*n	N is a positive integer	#*100
#*(expression)	The expression is:	
	1. Number	#*[100]
	2. Variables	#*[#10]
	3. Operational	#*[#1*#2]
	4. Function	#*[sin(#2)]

Sample program: find the sum of 1 to 100 bases

```

O0095
#1=0                Initial value
#2=1                Initial value of the addend
WHILE[#2LE100]DO1  Execute the loop body when the addend
                    is less than 100
#1=#1+#2           Calculation
#2=#2+2           Next odd number
END1                Jump to the loop body
    
```

Note: * indicates any "v", "V", "u", "U", "s", "S", "r", "R", "m", "M", "b", "B", "c", "C" character in <>. For example: #1, #v1, #V1, #u1, #U1, #s1, #S1, #r1, #R1, #m1, #M1, #b1, #B1, #c1, #C1

Model Description

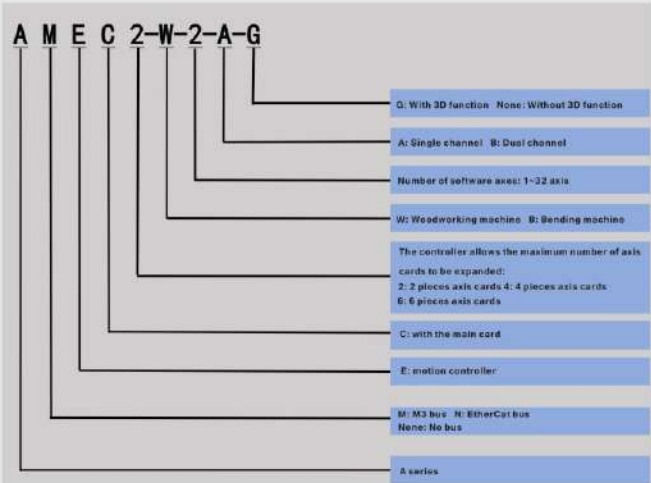
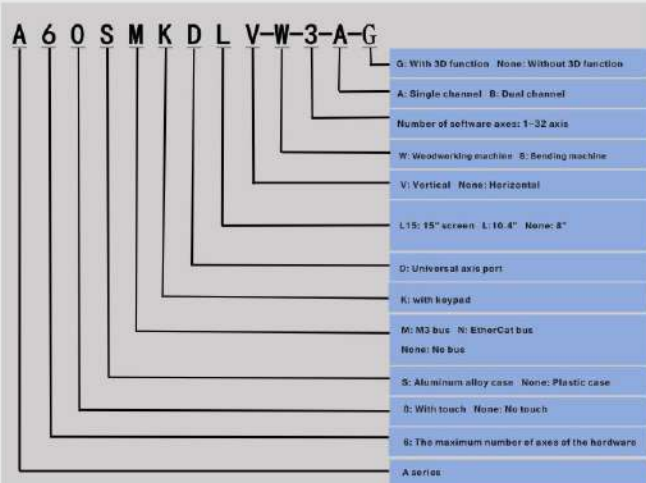

Specifications	A6 touch CNC controller		A6 standard controller
Maximum number of control axes	32 groups (pulse / analog / M3 bus / PWM)		
Maximum number of spindles	10 groups (simulated two open loops. Closed loop / pulse command / M3 bus)		
Minimum computation cycle	0.5MS		
Bus function	Support (Yakawa MECHATRPLINK-III) external Yaskawa $\Sigma 7$ bus type, HUST servo bus type		
Control method	Position control. Speed control (bandwidth adjustable) torque control		
Electronic cam. PID control	Support (the number of cams is not limited), each group of 16 PID retractable volumes		
Screen size	DVI interface can be expanded arbitrarily	8"/10.4"/12"/(may be developed)/15"	
Maximum input/output	256/256(1ms64IN/OUT.4ms192IN/OUT)		
MES module	Support (only supports 168bit MODBUS standard protocol. Free protocol. Communication library LIB mode)		
Communication protocol (master station. slave station)	Modbus. TCP/IP. FTP		
Communication protocol interface	USB (2 groups of OTG). RS232 (2 groups) RS485. Ethernet		
Acceleration/deceleration	Linear acceleration/deceleration. S-type acceleration/deceleration. Pre-plus acceleration/deceleration		
AD/DA	2 groups each (expandable 32 groups) 14Bit		
Fast input signal fixed length motion	Support (the highest precision response period 0.5us error)		
PWM output	5000Kbps		
Serial absolute encoder	SSI/BISS (6 groups. Maximum expandable to 12 groups)		
DXF vector graphics import	Support		
Network Server	Support (and support multiple slave functions)		
WIFI communication	Support (optional)		
Storage capacity	4GB		
RAM	512MB		
Cursor. Keyboard	Support		
Touch function	Optional	Standard	Optional

Accessories specifications

Order item number:A61SIO1O16



Input mode: NPN.PNP
 Input current: 10mA
 Single point output: MAX3A
 16 points/32 points
 output current: MAX16A

Order item number: : A61SIO1O32



Order Item number:A61SSR4



Factory fuse setting: 5A
 Rated voltage AC: 250V
 4 point output AC current: MAX 8A

Controller size

Order item number:AMEC

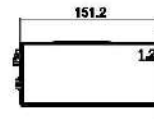
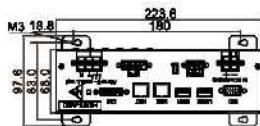

Order item number:AMEC2/AEC2

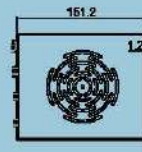
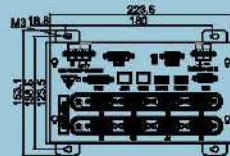

Order item number:AMEC4/AEC4

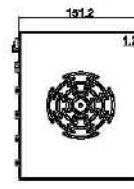
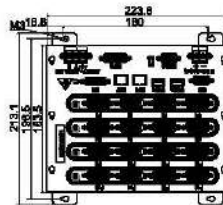

Order item number:AMEC6/AEC6

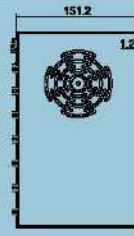
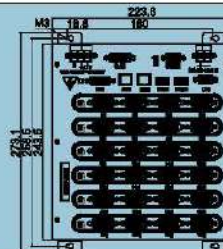
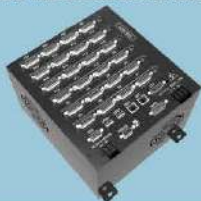

Order item number: A60MD/A60D

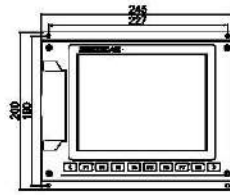

Order item number: A60MDL/A60DL

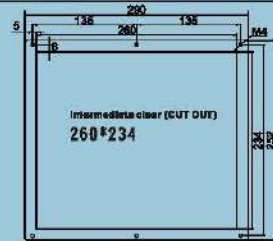
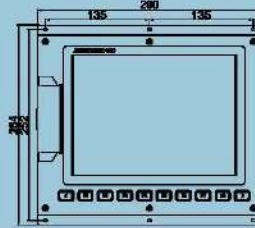

Order item number: A60SMDL/A60SDL

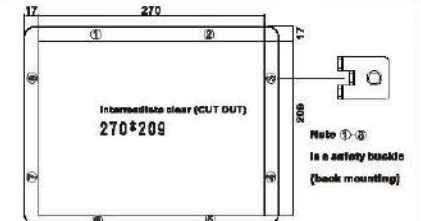
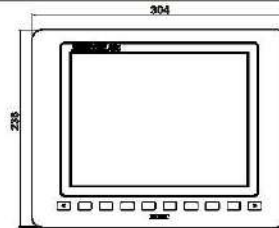

Order item number: A60MKDL15/A60SKDL15

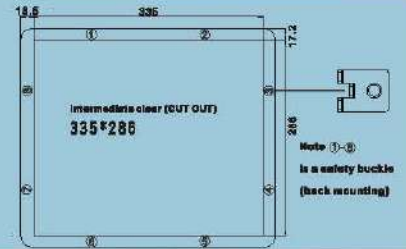
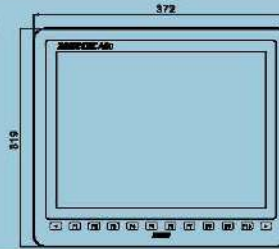

Order item number: A60MKD/A60KD

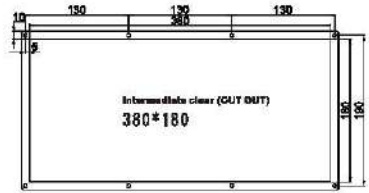
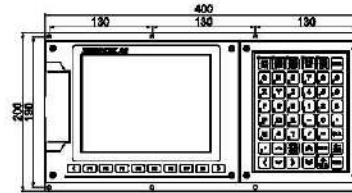

Order item number: A6MKDL/A6KDL

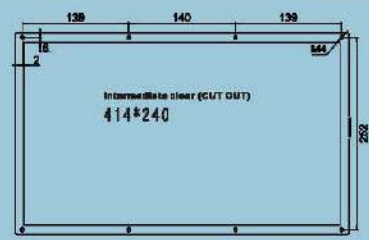
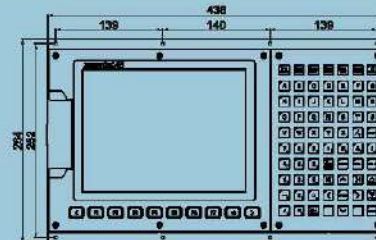

Order item number: A6MKDLV/A6KDLV

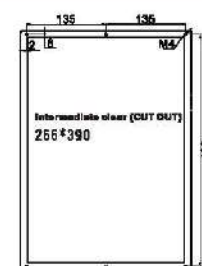
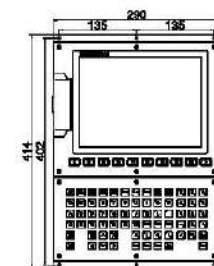



Address:

No. 80, Industrial Road, Toufen , Miaoli, Taiwan

TEL:+886-37-623242

FAX:+886-37-623241

Website www.hust.com.tw

Address:

6th floor of Chengding, Chuangyuan road, Zhongcun , Panyu district,

Guangzhou, Guangdong, china

Address:

Building III.6th Floor, Yabai Industrial Park, Chuangyuan Road, Zhongcun,

Panyu District, Guangzhou, China

TEL: +86-20-84780717 84780917

FAX: +86-20-34786951

Postal code: 511495

Website: www.hust-cnc.com



The company reserves the right to modify the contents of the catalogue without prior notice.

Agent: