

56.4mm (SIZE 23) HB TYPE

1.8°

RoHS対応
RoHS compliant products

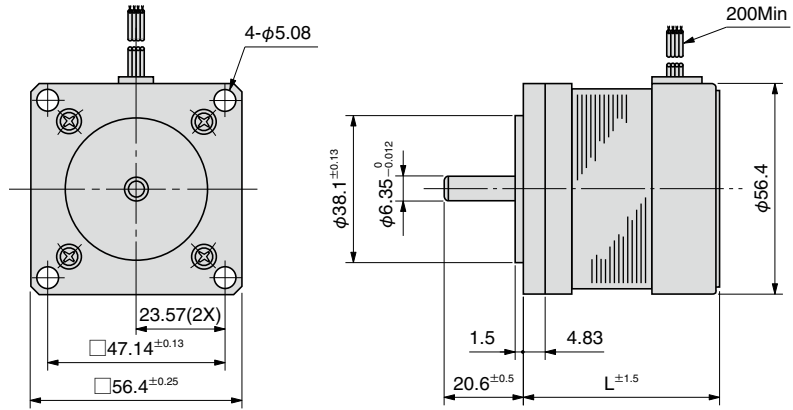

2相ステップモータ仕様

形式 Model Number	ステップ角 Step Angle Deg.	定格電圧 Rated Voltage V/Phase	定格電流 Rated Current A/Phase	巻線抵抗 Winding Resistance Ω/Phase	インダクタンス Inductance mH/Phase	ホールディングトルク Holding Torque N·m(kgf·cm)	モータ長L Motor Length mm	ロータイナーシャ Rotor Inertia x10 ⁻⁷ kg·m ²	質量 Mass kg	結線 Winding Type
TS3103N2E9	1.8	6.0	1.0	6.0	5.0	0.29 (2.9)	38.1	57	0.35	TYPE 2
TS3103N1E13	1.8	5.1	1.0	5.1	9.0	0.4 (4.0)	50.8	100	0.55	TYPE 2
TS3103N255	1.8	24.0	0.3	80.0	145.0	0.65 (6.5)	50.8	100	0.55	TYPE 2
TS3103N40	1.8	6.0	1.2	5.0	10.0	0.5 (5.0)	57.0	140	0.65	TYPE 2
TS3103N3E1	1.8	1.7	4.7	0.37	0.5	0.72 (7.2)	76.2	230	1.0	TYPE 2
TS3103N3E2	1.8	4.7	1.8	2.6	5.0	0.72 (7.2)	76.2	230	1.0	TYPE 2
TS3103N290	1.8	2.2	2.5	0.88	2.5	0.72 (7.2)	76.2	230	1.0	TYPE 1
TS3103N4E11	1.8	2.5	4.6	0.54	0.8	1.08 (10.8)	101.6	320	1.2	TYPE 2
TS3103N4E12	1.8	3.4	2.9	1.24	2.3	1.08 (10.8)	101.6	320	1.2	TYPE 2

- 使用周囲温度 ———— -20~+50℃
Operating temperature range
- 絶縁抵抗 ———— 100MΩ Min (at DC500V)
Insulation resistance
- 絶縁耐圧 ———— AC 500V (1min)
Dielectric strength
- スラストブレィ ———— 0.075mm Max at the load
9.8N(1.0kgf)
Thrust play
- ラジアルブレィ ———— 0.02mm Max at the load
4.9N(500gf)
Radial play
- 許容温度上昇 ———— 80℃ Max (Resistance method)
Permissible temperature rise

※ご注意：モータのケース表面温度は90℃以下でお使いください。

※NOTE：Do not allow the surface temperature of the motor case to rise above 90℃ during operation.

結線図 WIRING DIAGRAM

TYPE 1 バイポーラ BIPOLAR

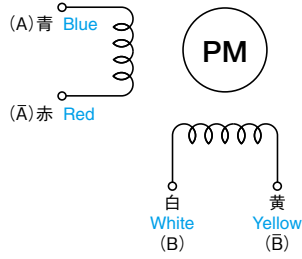

回転方向
出力軸より見て CW 方向 CW rotation from output shaft end.

Step	青 Blue	白 White	赤 Red	黄 Yellow
0	+	-	-	+
1	+	+	-	-
2	-	+	+	-
3	-	-	+	+
0	+	-	-	+

TYPE 2 ユニポーラ UNIPOLAR

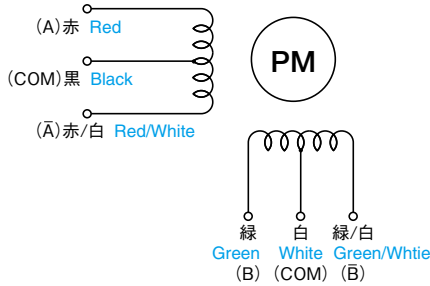

回転方向
出力軸より見て CW 方向 CW rotation from output shaft end.

Step	赤 Red	緑 Green	赤/白 Red/White	緑/白 Green/White	黒 Black	白 White
0	ON	ON			COM	COM
1		ON	ON		COM	COM
2			ON	ON	COM	COM
3	ON			ON	COM	COM
0	ON	ON			COM	COM

パルスレイトートルク特性 (プルアウトトルク) PULSE RATE VS TORQUE CHARACTERISTICS (Pull-out Torque)

TS3103N2E9

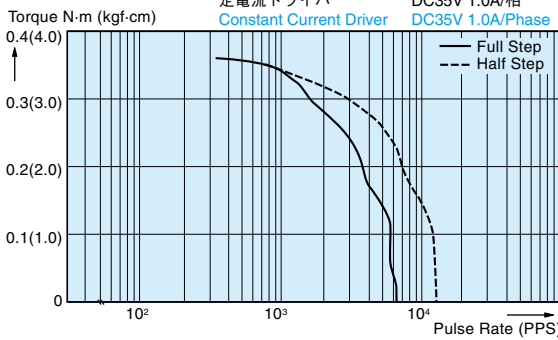

TS3103N1E13

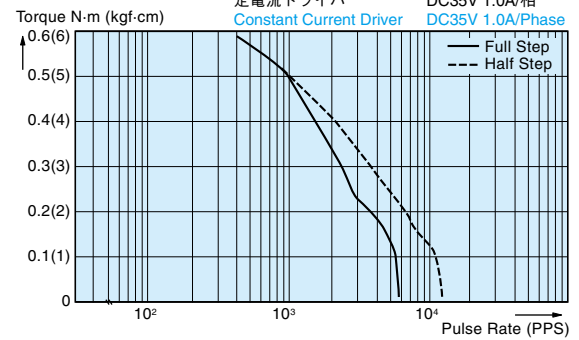

TS3103N40

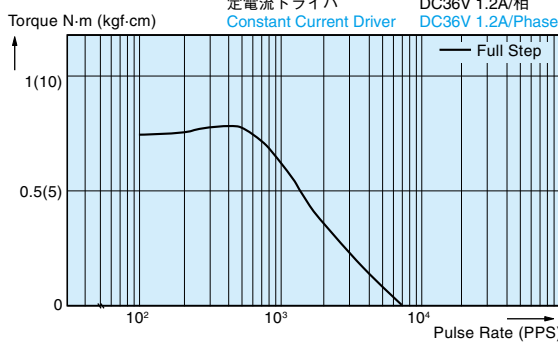

TS3103N3E2

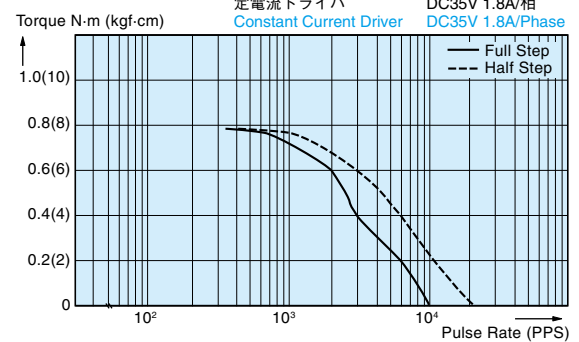

TS3103N4E12

