

56.4mm (SIZE 23) HB TYPE

高トルク・低振動
High torque · Low vibration

1.8°

CE EMC指令に適合していることを自己宣言します。
Self-certification products, RoHS compliant products

RoHS対応

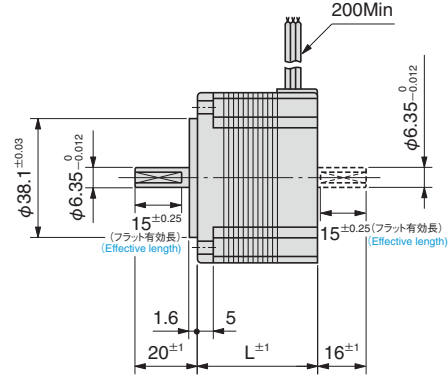
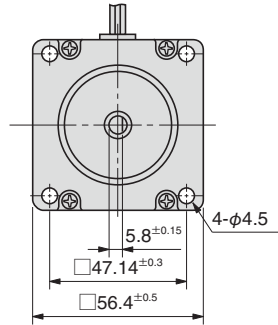
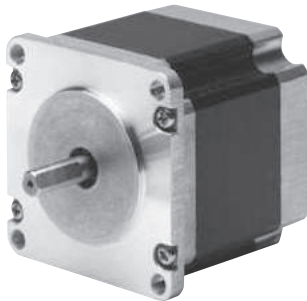

2相ステップモータ仕様

形式 Model Number		ステップ角 Step Angle	定格電圧 Rated Voltage	定格電流 Rated Current	巻線抵抗 Winding Resistance	インダクタンス Inductance	ホールディングトルク Holding Torque	モータ長L Motor Length	ロータイナーシャ Rotor Inertia	質量 Mass	結線 Winding Type
片軸 Single Shaft	両軸 Dual Shaft	Deg.	V/Phase	A/Phase	Ω/Phase	mH/Phase	N·m(kgf·cm)	mm	x10 ⁻⁷ kg·m ²	kg	
TS3653N1E1	TS3653N11E1	1.8	5.2	1.0	5.2	5.4	0.39 (3.9)	39	120	0.45	TYPE 2
TS3653N1E2	TS3653N11E2	1.8	2.8	2.0	1.4	1.4	0.39 (3.9)	39	120	0.45	TYPE 2
TS3653N1E3	TS3653N11E3	1.8	1.9	3.0	0.63	0.6	0.39 (3.9)	39	120	0.45	TYPE 2
TS3653N2E4	TS3653N12E4	1.8	7.2	1.0	7.2	11	0.9 (9)	54	260	0.7	TYPE 2
TS3653N2E5	TS3653N12E5	1.8	3.6	2.0	1.8	2.5	0.9 (9)	54	260	0.7	TYPE 2
TS3653N2E6	TS3653N12E6	1.8	2.3	3.0	0.75	1.2	0.9 (9)	54	260	0.7	TYPE 2
TS3653N3E7	TS3653N13E7	1.8	8.2	1.0	8.2	14	1.35 (13.5)	76	430	1	TYPE 2
TS3653N3E8	TS3653N13E8	1.8	4.5	2.0	2.25	3.6	1.35 (13.5)	76	430	1	TYPE 2
TS3653N3E9	TS3653N13E9	1.8	3	3.0	1	1.6	1.35 (13.5)	76	430	1	TYPE 2
TS3653N4E12	TS3653N14E12	1.8	2.2	5.0	0.44	1.4	2 (20)	84	520	1.3	TYPE 1

- 使用周囲温度 ———— -20~+50°C
Operating temperature range
- 絶縁抵抗 ———— 100MΩ Min (at DC500V)
Insulation resistance
- 絶縁耐圧 ———— AC 500V (1min)
Dielectric strength
- スラストプレイ ———— 0.075mm Max at the load
9.8N(1kgf)
Thrust play
- ラジアルプレイ ———— 0.025mm Max at the load
4.9N(0.5kgf)
Radial play

- 許容温度上昇 ———— 80°C Max (Resistance method)
Permissible temperature rise
- ※ご注意：モータのケース表面温度は90°C以下でお使いください。
※NOTE: Do not allow the surface temperature of the motor case to rise above 90°C during operation.

結線図 WIRING DIAGRAM

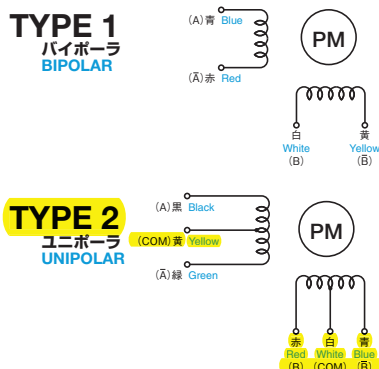

回転方向
出力軸より見てCW方向 CW rotation from output shaft end.

Step	青 Blue	白 White	赤 Red	黄 Yellow
0	+	-	-	+
1	+	+	-	-
2	-	+	+	-
3	-	-	+	+
0	+	-	-	+

回転方向
出力軸より見てCW方向 CW rotation from output shaft end.

Step	黒 Black	赤 Red	緑 Green	青 Blue	黄 Yellow	白 White
0	ON	ON			COM	COM
1		ON	ON		COM	COM
2			ON	ON	COM	COM
3	ON			ON	COM	COM
0	ON	ON			COM	COM

パルスレートートルク特性 (プルアウトトルク)
PULSE RATE VS TORQUE CHARACTERISTICS (Pull-out Torque)

TS3653N1E1,N11E1

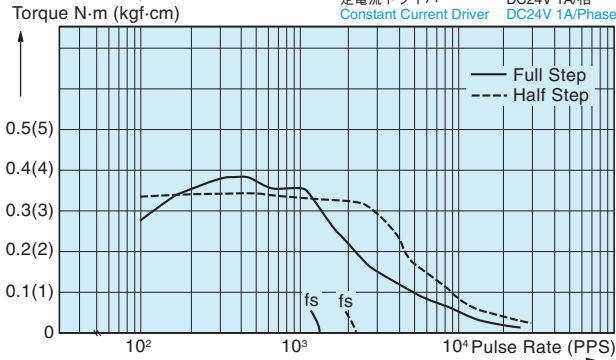

TS3653N1E2,N11E2

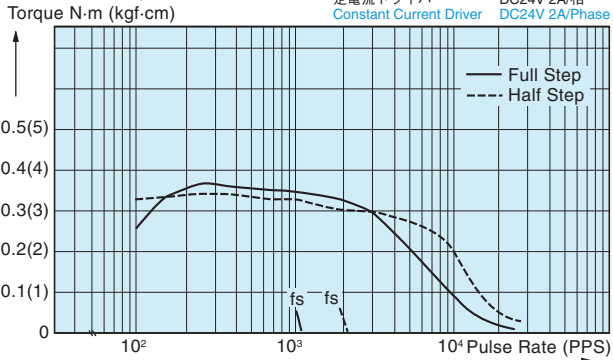

TS3653N1E3,N11E3

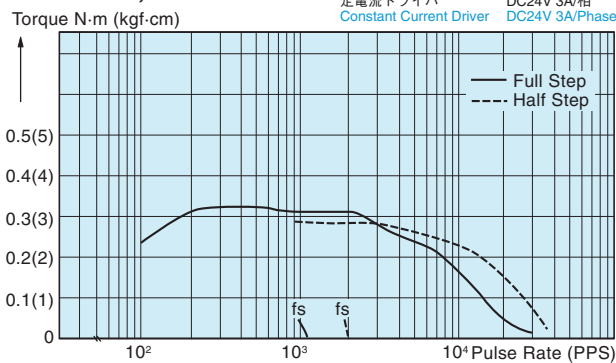

TS3653N2E4,N12E4

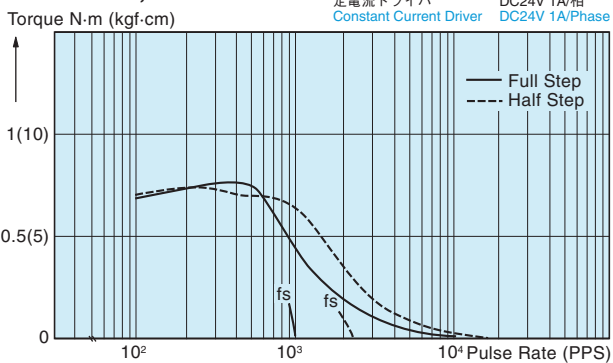

TS3653N2E5,N12E5

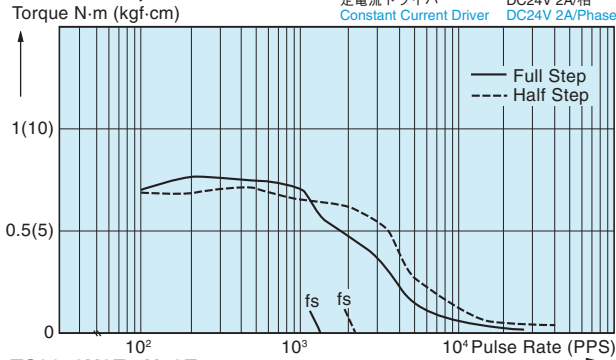

TS3653N2E6,N12E6

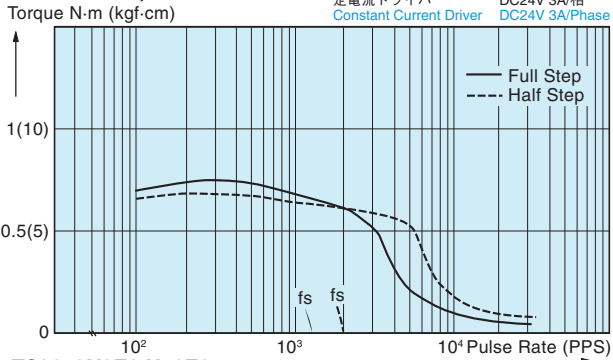

TS3653N3E7,N13E7

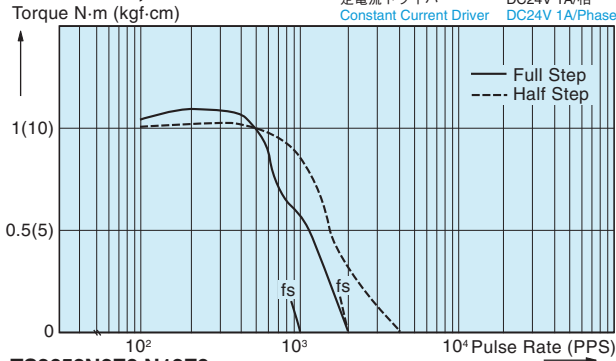

TS3653N3E8,N13E8

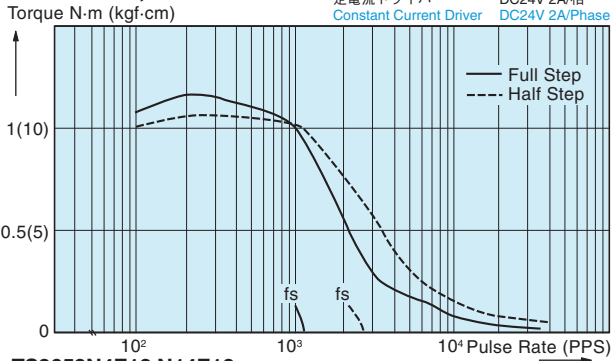

TS3653N3E9,N13E9

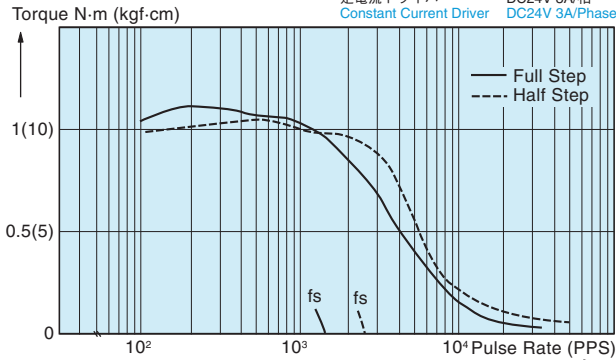

TS3653N4E12,N14E12

