

DTM Temperature Controller Operating Manual V1.0

Contents

Chapter 1: Product Introduction

1.1 Product Overview	1-1
1.2 Product Features	1-1
1.3 External Appearance of Product and Names of Parts	1-2
1.4 Purchase Information	1-3
1.5 Product Dimensions	1-4

Chapter 2: Specifications and System Configuration

2.1 Electrical Specifications	2-1
2.2 Temperature Sensor Type and Temperature Range	2-2
2.3 Performance	2-3
2.4 Station Number Settings	2-4
2.5 RS485/USB Communications Protocol Settings	2-5
2.5.1 USB Function	2-5
2.6 Ethernet Communications Protocol Settings	2-6
2.6.1 Function	2-6
2.6.2 Functional Specifications.....	2-6
2.6.3 MODBUS TCP Communication Standards.....	2-8
2.6.4 Troubleshooting.....	2-8
2.7 Initial Power on State	2-9
2.7.1 Light Display Status	2-7
2.8 Definitions of Commonly Used Terms	2-10
2.9 Restoring Default Settings	2-11

Chapter 3: Input Function Configuration

3.1 Input Functions	3-1
3.1.1 Input Function Settings	3-1
3.1.2 Input Type, Range, and Corresponding Communications Content	3-2
3.1.3 Read the Present Value and Setpoint Value	3-3
3.1.4 Analog Input (Voltage, Current) Applications	3-4
3.2 Operating Interface	3-4
3.2.1 Temperature Filter and Input Error Settings	3-4
3.2.2 Input Error Settings	3-4

3.3 Other Input Function Settings	3-5
3.3.1 Channel Disabled	3-5
3.3.2 Temperature Units	3-6
3.3.3 Cold Junction Compensation Selection	3-6
3.3.4 Input channel status	3-8

Chapter 4: Output and Alarm Function Configuration

4.1 Output Functions	4-1
4.1.1 Explanation of Output Functions	4-1
4.1.2 Physical Output Type	4-1
4.1.3 Output Function Settings	4-1
4.2 Assign the Addresses for I/O Expansion Module	4-2
4.3 Alarm Functions	4-3
4.3.1 Explanation of Alarm Functions	4-3
4.3.2 Alarm Function Settings	4-5
4.4 Other Output Function Settings	4-6
4.4.1 Output Level When Input Sensor Error	4-6
4.4.2 Analog Output Compensation Adjustment	4-7

Chapter 5: Control Functions and Operating Instructions

5.1 Control Functions	5-1
5.1.1 Explanation of Control Functions	5-1
5.1.2 Control Function Settings	5-5
5.2 Multiple-group PID Option Settings	5-9
5.2.1 Selection of a PID Group	5-9
5.2.2 Group Parameter Settings	5-9

Chapter 6: Operating Instructions for Other Auxiliary Functions

6.1 Self-definition of Functions (Default)	6-1
6.1.1 Explanation of Self-definition of Functions (Default)	6-1
6.1.2 Settings for Self-definition of Functions (Default)	6-1
6.2 Self-definition of Functions (Self-defined)	6-5
6.2.1 Explanation of Self-definition of Functions (Self-defined)	6-5
6.2.2 Settings for Self-definition of Functions (Self-defined)	6-5
6.3 CT alarm functions	6-6
6.3.1 Explanation of CT alarm functions	6-6
6.3.2 CT alarm function settings	6-7

Chapter 7: Appendix

7.1 RS485 Communications	7-1
---------------------------------	------------

7.1.1 Comm. commands for DTM Host and Measurement Expansion Module	7-1
7.1.2 Operating Commands for Expansion Cassette Series	7-8
7.1.3 DTM-DOx Series Accessory Operating Commands	7-9
7.1.4 DTM-CT Series Accessory Operating Commands	7-9
7.1.5 Programmable Control Planning Table Parameter Settings	7-10
7.1.6 PID Group Parameter Settings	7-11
7.1.7 Modbus Communications Function Code	7-13
7.2 Installation method	7-16
7.2.1 Host	7-16
7.2.2 Expansion Cassette	7-17
7.2.3 Measurement Expansion Module, I/O Expansion Module	7-19
7.2.4 Installation Guidelines	7-20
7.2.5 Terminal Configuration Diagram	7-21
7.3 Ethernet/ IP Software Setting	7-23
7.3.1 Setting up Communication and Searching for Modules in DCISoft	7-23
7.3.2 Basic Settings	7-28
7.3.3 Network Settings.....	7-30
7.3.4 IP Filter	7-32
7.3.5 Security	7-33
7.3.6 Returning to Default Settings	7-34
7.3.7 Application Examples	7-35
7.4 Product service	7-40

Precautions

- ⚠ Because this product is an open device, it must be installed in a dustproof, moisture-resistant, shock/impact-resistant case before use. Protective measures (such as only special tools or a key can open the case) should be used to prevent operation by non-maintenance personnel or accidental impacts, which may cause risk and damage.
- ⚠ Note: Please comply with the precautions in this user guide. If failure to comply with these precautions and guidelines cause the controller or peripheral products to malfunction, this may lead to such severe consequences as fire or shocks and even injury or death.
- ⚠ Note: Shock hazard! To avoid electric shocks, after the device has been powered up, please do not touch the AC power terminals. When checking the input power, make sure that power is off.
- ⚠ To avoid personal injury and damage to other equipment, because this product is an open device, please avoid using in hazardous application situations. Please install this device on equipment with fail safe protective devices.
- ⚠ This device is not equipped with a power switch or fuses. This products application system should therefore have a switch or circuit-breaker, and the switch or circuit-breaker must be in locations easily accessible to operators and have clearly visible on-off markings.
 1. Please use needle-type terminals with front-end crimping areas with a diameter smaller than 2.35mm. Avoid using excessive force when attaching wires to the terminals, and confirm that wires are attached to the correct terminals.
 2. If any dust or metal shavings get into the body of the device, this may cause faulty operation; please install in a dustproof, moisture-resistant, shock/impact-resistant electrical case before use.
 3. Modifying or disassembling this controller without authorization may cause unforeseeable errors or hazards. Do not use any extra empty terminals.
 4. To avoid interference, avoid places with high voltages, high-frequency noise, or high electrical currents during installation.
 5. Avoid using this device in places where the following situations may occur:
 - (a) Where there are high levels of dust or corrosive or flammable gases;
 - (b) High humidity and condensation;
 - (c) Vibration and impacts;
 - (d) High radiation.
 6. Make sure to turn off power before installing wiring or changing the temperature controller.
 7. When extending or attaching thermocouple lead wires, be sure to use compensating lead wires compatible with the thermocouple type.
 8. When using three-wire type platinum measurement impedance body, make sure that the diameters and lengths of the three wires are the same, which will reduce measurement error. When extending or attaching platinum measurement impedance body lead wires, to avoid affecting temperature values, be sure to use lead wires with the correct length and impedance.
 9. To avoid interference from noise and inductance, be sure to use only short-distance wires from temperature detectors to the body of the temperature controller. Make sure to separate sensor wires from AC power lines and heavy load wires.
 10. Before powering up the device, confirm that the power/ signal equipment are correct;

Foreword

otherwise, there is risk of severe damage.

11. When powering up the device, take care not to touch or try to maintain terminals on the device, which may cause electrical shocks.
12. When power is turned off for less than 1 min., because electricity in wires may not be fully discharged, do not touch internal wiring or external terminals.
13. When maintaining the temperature controller, turn off power and use a dry cloth to clean the surface of the device. To avoid damaged circuits and causing malfunction, do not open the case and touch the internal circuits. Do not clean using acidic or alkaline liquids.
14. If using a measurement expansion module and I/O expansion module simultaneously, install the I/O expansion module only after the measurement expansion module has been fully installed.
15. To avoid possible damage due to different system voltages, confirm that the contacts on each expansion cartridge or I/O expansion module are the same voltage as the system.
16. All measurement expansion modules, expansion cartridges, and I/O expansion modules must be compatible with the DTM system.
17. When adding/replacing a measurement expansion module, I/O expansion module, or expansion cartridge, make sure power has been shut off to the system, and power up the system after installation. The products in this series do not support hot swapping; please perform installation only after power has been turned off.
18. To avoid interference from noise and inductance, when using a CT sensor, measurement lead wires should be kept far from the main DTM unit.
19. When inserting a cord-end terminal, be sure to use a straight screwdriver; maintain safety by avoiding working with your bare hands.

Version revision history

Version	Content of revisions	Date issued
Ver. 1	Ver. 1 issued	2020/02/22

Chapter 1

Product Introduction

1.1 Product Overview

The DTM host provides 8 inputs to connect sensors, can simultaneously measure the temperature at 8 points and control 8 different outputs, and can rely on peripheral expansion modules with various I/O functions to add output control channels or alarm control channels.

The DTM series includes: The host, measurement expansion module, I/O expansion module, and expansion cartridge. A DTM group can include a maximum of one host linked with 7 measurement expansion modules and 8 I/O expansion modules, and can control the 64 points temperature; RS485 or Ethernet can be used to link multiple DTM groups, which can realize temperature control over hundreds points.



1.2 Product Features

The DTM series is a multi-loop modular temperature controller, and its modular design can facilitate installation and application by users. The host collects data and input channels are isolated from each other for high communication efficiency and measurement stability. Users can also define functions, and assign communications function addresses.

- ✓ A modular design simplifies wiring installation.
- ✓ Expansion models with various functions can meet the needs of different applications.
- ✓ Data collection by the host enhances information exchange performance.
- ✓ Supports RS485 and Ethernet communications, and multi-point temperature control.
- ✓ A communication function address self-definition function.
- ✓ Channels are completely isolated from each other.
- ✓ Each input channel can support multiple type sensors.

Chapter 1: Product Introduction

1.3 External Appearance of Product and Names of Parts

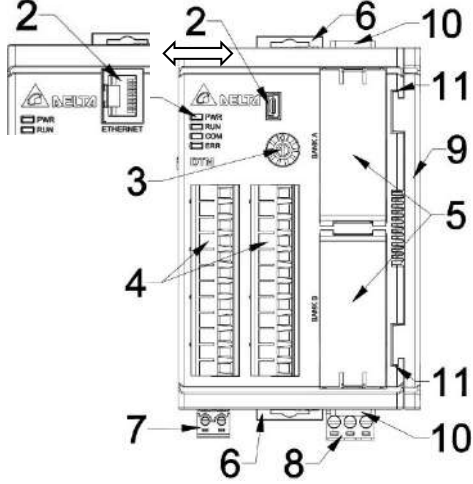
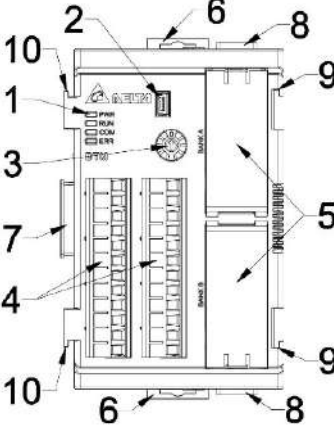
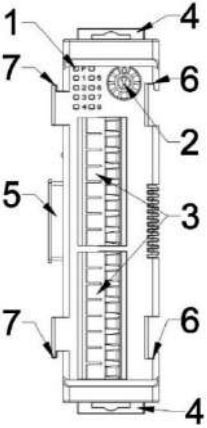
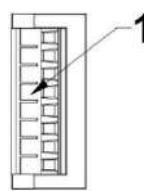
Measurement Host																																	
	<table border="1"> <thead> <tr> <th>Serial No.</th> <th>Name</th> </tr> </thead> <tbody> <tr> <td>1</td> <td>LED status light</td> </tr> <tr> <td>2</td> <td>RJ45 connector(left)/ Mini USB connector(right)</td> </tr> <tr> <td>3</td> <td>Node number selection dial</td> </tr> <tr> <td>4</td> <td>Sensor input terminal</td> </tr> <tr> <td>5</td> <td>Protective cover of expansion output port</td> </tr> <tr> <td>6</td> <td>DIN rail fastener</td> </tr> <tr> <td>7</td> <td>RS485 communications terminal</td> </tr> <tr> <td>8</td> <td>Power input terminal</td> </tr> <tr> <td>9</td> <td>Side protective cover</td> </tr> <tr> <td>10</td> <td>Output cartridge fastener</td> </tr> <tr> <td>11</td> <td>Expansion channel guide</td> </tr> </tbody> </table>	Serial No.	Name	1	LED status light	2	RJ45 connector(left)/ Mini USB connector(right)	3	Node number selection dial	4	Sensor input terminal	5	Protective cover of expansion output port	6	DIN rail fastener	7	RS485 communications terminal	8	Power input terminal	9	Side protective cover	10	Output cartridge fastener	11	Expansion channel guide								
	Serial No.	Name																															
	1	LED status light																															
	2	RJ45 connector(left)/ Mini USB connector(right)																															
	3	Node number selection dial																															
	4	Sensor input terminal																															
	5	Protective cover of expansion output port																															
	6	DIN rail fastener																															
	7	RS485 communications terminal																															
	8	Power input terminal																															
	9	Side protective cover																															
10	Output cartridge fastener																																
11	Expansion channel guide																																
Measurement expansion module																																	
	<table border="1"> <thead> <tr> <th>Serial No.</th> <th>Name</th> </tr> </thead> <tbody> <tr> <td>1</td> <td>LED status light</td> </tr> <tr> <td>2</td> <td>Mini USB connector</td> </tr> <tr> <td>3</td> <td>Node number selection dial</td> </tr> <tr> <td>4</td> <td>Sensor input terminal</td> </tr> <tr> <td>5</td> <td>Protective cover of expansion output port</td> </tr> <tr> <td>6</td> <td>DIN rail fastener</td> </tr> <tr> <td>7</td> <td>Adapter protective cover</td> </tr> <tr> <td>8</td> <td>Output cartridge fastener</td> </tr> <tr> <td>9</td> <td>Expansion channel guide</td> </tr> <tr> <td>10</td> <td>Expansion channel guide</td> </tr> </tbody> </table>	Serial No.	Name	1	LED status light	2	Mini USB connector	3	Node number selection dial	4	Sensor input terminal	5	Protective cover of expansion output port	6	DIN rail fastener	7	Adapter protective cover	8	Output cartridge fastener	9	Expansion channel guide	10	Expansion channel guide										
	Serial No.	Name																															
	1	LED status light																															
	2	Mini USB connector																															
	3	Node number selection dial																															
	4	Sensor input terminal																															
	5	Protective cover of expansion output port																															
	6	DIN rail fastener																															
	7	Adapter protective cover																															
	8	Output cartridge fastener																															
9	Expansion channel guide																																
10	Expansion channel guide																																
I/O expansion modul/DTMN02-x	Expansion cassette																																
		<table border="1"> <thead> <tr> <th>Serial No.</th> <th>Name</th> </tr> </thead> <tbody> <tr> <td>1</td> <td>LED status light</td> </tr> <tr> <td>2</td> <td>Node number selection dial</td> </tr> <tr> <td>3</td> <td>Output / input terminal</td> </tr> <tr> <td>4</td> <td>DIN rail fastener</td> </tr> <tr> <td>5</td> <td>Adapter protective cover</td> </tr> <tr> <td>6</td> <td>Expansion channel guide</td> </tr> <tr> <td>7</td> <td>Expansion channel guide</td> </tr> </tbody> </table>	Serial No.	Name	1	LED status light	2	Node number selection dial	3	Output / input terminal	4	DIN rail fastener	5	Adapter protective cover	6	Expansion channel guide	7	Expansion channel guide	<table border="1"> <thead> <tr> <th>Serial No.</th> <th>Name</th> </tr> </thead> <tbody> <tr> <td>1</td> <td>Output terminal</td> </tr> <tr> <td></td> <td></td> </tr> <tr> <td></td> <td></td> </tr> <tr> <td></td> <td></td> </tr> <tr> <td></td> <td></td> </tr> <tr> <td></td> <td></td> </tr> </tbody> </table>	Serial No.	Name	1	Output terminal										
		Serial No.	Name																														
		1	LED status light																														
		2	Node number selection dial																														
		3	Output / input terminal																														
		4	DIN rail fastener																														
		5	Adapter protective cover																														
6	Expansion channel guide																																
7	Expansion channel guide																																
Serial No.	Name																																
1	Output terminal																																

1.4 Purchase Information

DTM 1 2 3

Series name	Deltas DTM series temperature controller (includes side protective cover)
1 Communications interface	R = USB + RS485 E = Ethernet + RS485
2 Number of channels	04 = 4 channels 08 = 8 channels
3 Derivative device types	Blank = standard product

DTM 1 2 3

Series name	Delta DTM series temperature control measurement expansion module
1 Communications interface	N = None (N is the measurement expansion module without external communications)
2 Number of channels	Code 1 = N 02 = 2 channels 04 = 4 channels 08 = 8 channels
3 Optional functions	Only Code 2 = 02 has the following selection, - C = linear current output (source type) - L = linear voltage output - R = relay output - V = DC voltage pulse output (source type)

DTM - 1 2

Series name	Delta DTM series temperature control accessories
1 Module type	BD = expansion cassette DO = output expansion module CT = CT sensor
2 Specifications	Code 1 = BD / DO device type: C = linear current output (source type) L = linear voltage output R = relay output V = DC voltage pulse output (source type)
	Code 1 = CT device type: 030 = 30A (default input range) Product standard configuration has no CT sensor accessories (CT sensor is an optional accessory)

❖ Notes:

1. The standard configuration of the DTM host and measurement expansion module at time of shipping has no expansion cassette, which may be selected by the customer.
2. DTM series comes with all needed cord-end terminals.

Chapter 1: Product Introduction

1.5 Product Dimensions

Measurement Host (units: mm)

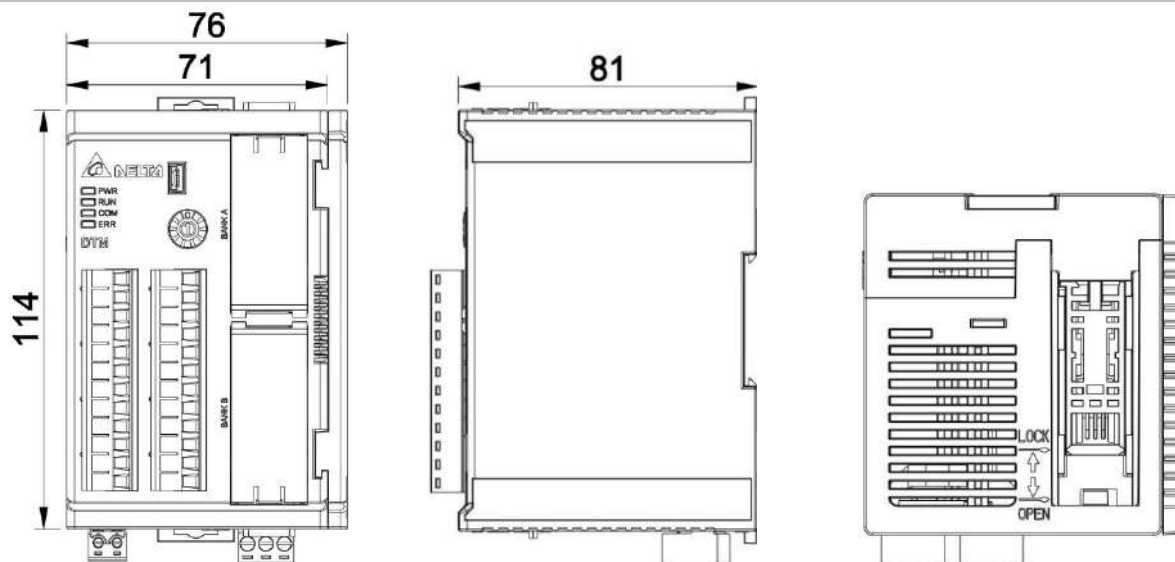

Measurement expansion module (units: mm)

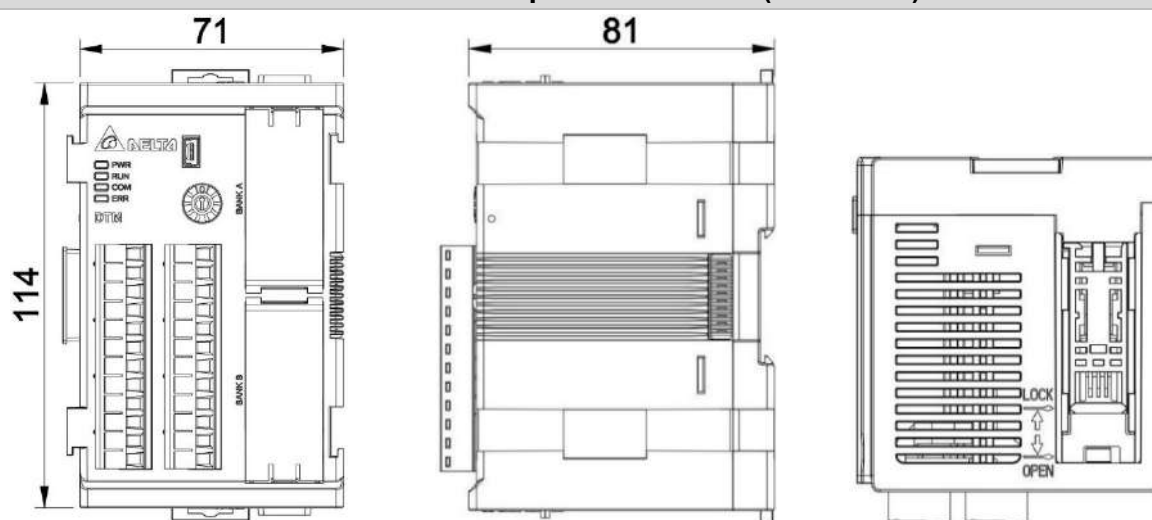

I/O expansion module (units: mm)

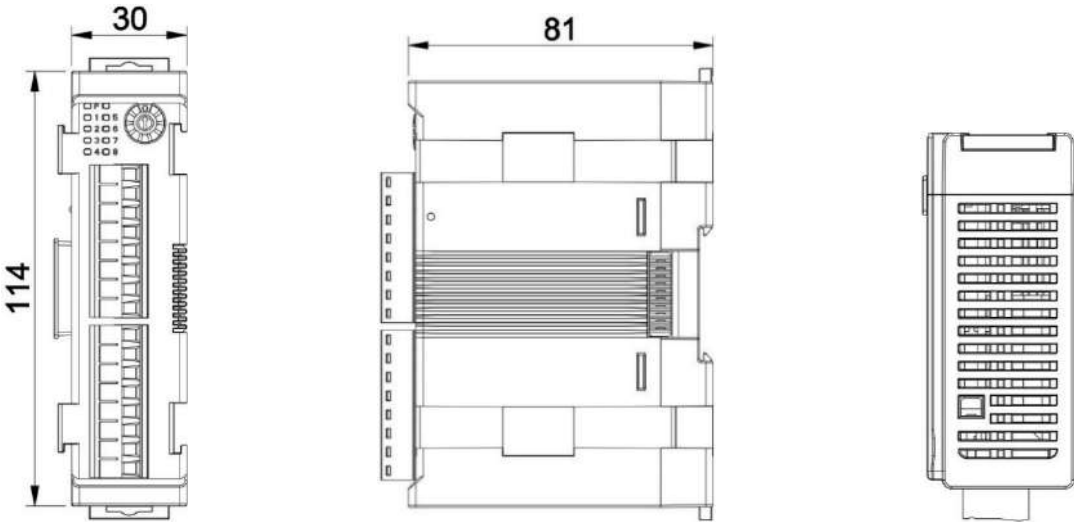

Chapter 2

Specifications and System Configuration

2.1 Electrical Specifications

Input power	24V DC
Operating voltage	90% ~ 110% of rated voltage
Power consumption	Host Max. (maximum number of channels) 6W + 5W × number of measurement expansion modules in parallel + 3W × number of I/O expansion module in parallel Expansion cassette power consumption is already included in the host or measurement expansion module
Installation requirement	Please install according to the sequence 【Host → measurement expansion modules (Max. 7 modules)→ I/O expansion modules (Max. 8 modules)】 If the measurement expansion modules include DTMN02-x series, be sure to install DTMN08 / N04 before installing DTMN02-x, Each DTM group can only expand one DTMN02-x measurement expansion module
Input sensor support	Thermocouple : K, J, T, E, N, R, S, B, L, U, TXK
	RTD: Pt100, JPt100, Ni120, Cu50
	Analog input: 0 - 10V, 0 - 5V, 0 - 50mV, 0 - 20mA, 4 - 20mA
Sampling frequency	0.1 sec./all 8 inputs
Control mode	PID, programmable PID design, ON/OFF, manual
Output types	Relay output, SPST, rated maximum load of AC 250V, 2A resistive load.
	Voltage pulse output, DC 12V±10%, rated maximum output current of 20mA.
	Analog current output 4~20mA (load impedance must be ≤500Ω)
	Analog voltage output 0~10V (load impedance must be ≥1,000Ω)
Input accessory types	When there is an optional CT device, the customer should select a current transformer (CT), with selection information as follows: 1. 30A CT model: DT3-CT30A; 2. 100A CT model: DT3-CT100A, resolution of 0.1A
Output functions (optional)	Optional control output, alarm output, or proportional output (must have an optional output device type)
Alarm function (optional)	17 alarm modes may be selected (must have an optional output device type)
Communications functions	RS-485 communications: support baud rates of 4800/9600/19200/38400/57600/115200bps Ethernet communications: supports 10/100Mbps, MDI/MDI-X automatic detection, 1 Port, RJ45 USB communications: supports USB 2.0 Full Speed only for the host
Communication protocol	RS485: support the Modbus protocol with RTU/ASCII communications format Ethernet: support Modbus TCP and Ethernet/IP, IEEE802.3, IEEE802.3u transmission method

Chapter 2: Specifications and System Configuration

	USB: support USB2.0 communications standard
Transmission cable (Ethernet)	Category 5e shielding 100M
Internal connection functions	Provides internal connection terminals with 24V power and communications signal provided
Vibration resistance	10 - 55Hz; 10m/s ² ; 3-axial directions; 10 min.
Shock resistance	Maximum of 300m/s ² ; 3-axis, 6-directions; 3 times each
Operating temperature	0°C - +50°C
Storage temperature	-20°C - +65°C
Operating altitude	Below 2,000 meters above sea level
Operating humidity	35% to 85% RH (no dew)
Pollution level	2

2.2 Temperature Sensor Type and Temperature Range

Input sensor type	Communication register value	Temperature range	Input sensor type	Communication register value	Temperature range
Thermocouple K type	0	-200 - 1300°C	Thermocouple TXK type	10	-150 - 800°C
Thermocouple J type	1	-100 - 1200°C	Platinum measurement resistance (JPt100)	11	-20 - 400°C
Thermocouple T type	2	-200 - 400°C	Platinum measurement resistance (Pt100)	12	-200 - 850°C
Thermocouple E type	3	0 - 600°C	Resistance temperature sensor (Ni120)	13	-80 - 300°C
Thermocouple N type	4	-200 - 1300°C	Resistance temperature sensor (Cu50)	14	-50 - 150°C
Thermocouple R type	5	0 - 1700°C	Analog voltage input (0-5V)	15	-999-9999
Thermocouple S type	6	0 - 1700°C	Analog voltage input (0-10V)	16	-999-9999
Thermocouple B type	7	100 - 1800°C	Analog current input (0-20m A)	17	-999-9999
Thermocouple L type	8	-200 - 850°C	Analog current input (4-20m A)	18	-999-9999
Thermocouple U type	9	-200 - 500°C	Analog voltage input (0-50m V)	19	-999-9999

Chapter 2: Specifications and System Configuration

2.3 Performance

Temperature display precision	Thermocouple : $\pm(0.3\% \text{ FS}, +1^{\circ}\text{C})$
	Platinum measurement resistance: $\pm(0.2\% \text{ FS}, +1^{\circ}\text{C})$
Analog input precision	0 to 5 VDC: $\pm(0.3\% \text{ of reading}, +0.03\text{V})$
	0 to 10 VDC: $\pm(0.3\% \text{ of reading}, +0.03\text{V})$
	0 to 20 mA: $\pm(0.3\% \text{ of reading}, +0.05\text{mA})$
	4 to 20 mA: $(0.3\% \text{ of reading}, +0.04\text{mA})$
	0 to 50 mV: $\pm(0.3\% \text{ of reading}, +0.1\text{mV})$
CT input precision	CT input: $\pm(5\% \text{ of span})$
Limitation and effect of wires resistance	Thermocouple : affected by wires resistance
	K, J, T, E, N, L, U, TXK: $.1^{\circ}\text{C} (0.2^{\circ}\text{F}) / \Omega$
	B, R, S: $0.2^{\circ}\text{C}/\Omega \text{ max.}$
	RTD : under 10Ω for each wire

❖ Notes: FS = Full Scale

Chapter 2: Specifications and System Configuration

2.4 Station Number Setting

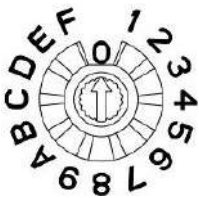
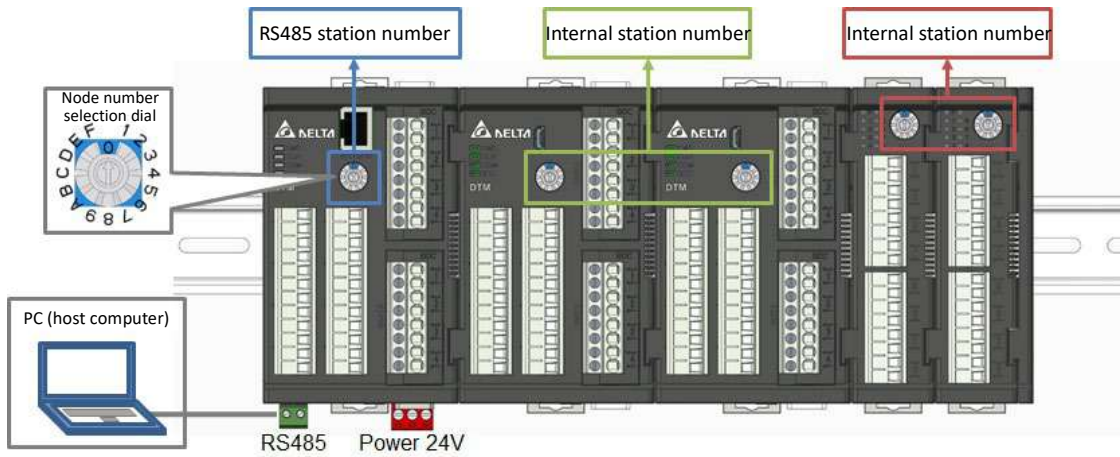

Setting range: 0-F
Default settings: 1

Module function	Station number selection dial functions	Corresponding station number
Measurement host	RS485 station number	1-F, 0=10 _{Hex}
Measurement expansion module	Internal station number	1~F, 0= invalid
I/O expansion module (DO)	Internal station number	1~F, 0= invalid
I/O expansion module (CT)	Internal station number	1~F, 0= invalid

In a DTM group, communications between the host and expansion modules is conducted via an internal communications bus; and communications with a host computer is conducted via the DTM hosts RS485, Ethernet, or USB. The hosts station number selection dial is therefore the RS485 station number setting, and the station number when the DTM host is employing internal communications is 0, which indicates that the communications protocol setting is also the setting for communications between the DTM hosts RS485 and the host computer. The station number selection dial for each expansion module is the internal station number for the groups internal communications; the communications protocol is defined as the internal protocol between the DTM host and its expansion modules, and users need only set the internal station number; however, users must remember that the station number of expansion modules with the same attributes cannot be repeated. The station numbers of expansion modules with different attributes may be the same, and this will not affect their function. The new settings will take effect when the DTM host is powered on again after the external switch has been reset.

Chapter 2: Specifications and System Configuration

2.5 RS485/ USB Communications Protocol Settings

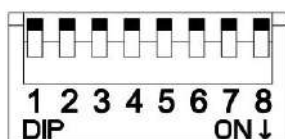
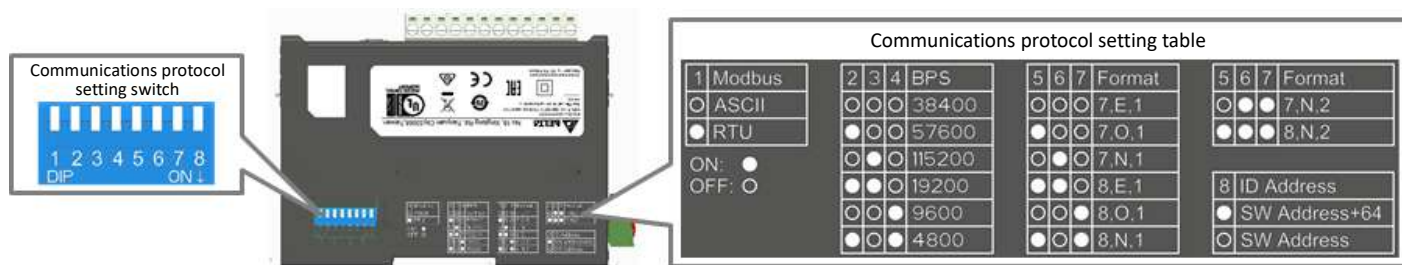

Default settings: All OFF
ASCII 38400,7,E,1

Bit 1	Communications encoding
OFF	ASCII (default value)
ON	RTU

Bit 2	Bit 3	Bit 4	Communications rate (bps)
OFF	OFF	OFF	3840 (default value)
ON	OFF	OFF	57600
OFF	ON	OFF	115200
ON	ON	OFF	19200
OFF	OFF	ON	9600
ON	OFF	ON	4800

Bit 5	Bit 6	Bit 7	Communications protocol format
OFF	OFF	OFF	7, E, 1 (default value)
ON	OFF	OFF	7,O,1
OFF	ON	OFF	7,N,1
ON	ON	OFF	8,E,1
OFF	OFF	ON	8,O,1
ON	OFF	ON	8,N,1
OFF	ON	ON	7,N,2
ON	ON	ON	8,N,2

Bit 8	Communications address special code
ON	The communications address is the switch setting address plus 64
OFF	Maintains original set communications address (default value)

2.5.1 USB Function

DTMR series host models have a USB communication, which can be connected via DTM soft (software and operation manual can be downloaded from Delta website). USB connection is only used for parameter or function setting, because USB has no signal isolation, **it cannot be used for long-term monitoring.**

Chapter 2: Specifications and System Configuration

2.6 Ethernet Communications Protocol Setting

DTME series models are Ethernet communication modules. IP addresses can be set through **DCISoft** (see **Chapter 7: Appendix** for installation paths and usage methods for details). DTME series models have the function of IP filtering. In addition, under the MDI / MDI-X automatic detection function, there is no need to jumper when using the network line. The following will introduce the DTME series models in more detail.

IP settings 192.168.1.5

Port setting: 502

2.6.1 Function

- ✓ Automatically detect 10/100 Mbps transmission rate
- ✓ MDI / MDI-X automatic detection
- ✓ Support Modbus TCP communication protocol
- ✓ Support EtherNet / IP Explicit message
- ✓ Support EtherNet / IP I/O connection implicit message
- ✓ Support software version: EIP Builder V1.07 or above

2.6.2 Functional Specifications

■ Interface

Items	Specifications
Interface	RJ-45 with Auto MDI/MDIX
Port number	1 Port
Transmission method	IEEE802.3, IEEE802.3u
Cables	Category 5e shielding 100M
Speed	10/100 Mbps Auto-Defect
Protocol	ICMP, IP, TCP, UDP, DHCP, BOOTP, Modbus TCP, EtherNet/IP, Delta Configuration

■ Modbus TCP

Items		Specifications
Normal	Device type	Server
	Maximum number of connections	4
	Maximum data length for a single connection	100 Words

Chapter 2: Specifications and System Configuration

■ EtherNet/IP

Items		Specifications
Normal	Device type	Adapter
	Topology support	Star
CIP Service type_ IO Connection	Maximum number of CIP connections (Number of communication lines that can be connected)	8 (Servers)
	Maximum number of TCP connections (Number of devices that can be connected)	8 (Servers)
	Packet transmission interval (Can be set interval time)	5 ms ~ 1000 ms
	Maximum communication capacity	400 pps
	Maximum data length for a single connection	500 bytes
CIP Service type_ Explicit Message	Class 3 (Connected type)	Identity Object (16#01) Message Router Object (16#02)
	UCMM (Unconnected Type, Only occupy TCP connection)	Assembly Object (16#04) Connection Manager Object (16#06) TCP/IP Interface Object (16#F5) Ethernet Link Object (16#F6) DTM Data Object (16#301) Does not support custom objects Object For component contents, please refer to appendix
	Support CIP objects	

Chapter 2: Specifications and System Configuration

2.6.3 MODBUS TCP Communication Standards

1. The supported function codes and communication addresses are the same as RS485. Please refer to the RS485 communication section in Appendix A.
 2. Since DTME08 / E04 is an IP address resolution machine, when editing communication instructions, the address of its RS485 station number can be written to any value.
- **Example:** If you want to use the Ethernet Modbus of DTME08 for communication function to read the PV value of 8 channels, you can issue the command [FF 03 0268 0008]. The “FF” part can be modified to any value. Only when using RS485 for communication, you need to confirm the station. The value of the number selector (see section 2.4).

2.6.4 Troubleshooting

Fault conditions	cause of issue	Troubleshooting method
No modules found	DTME Not connected to the network	Please check if DTME is properly connected to the network
	Computer and DTME are in different networks, blocked by network firewall	Please use the specified IP to find the relevant settings
Cannot open DTME settings page	DTME Not connected to the network	Please check if DTME is properly connected to the network
	DCISoft communication setting error	Please check if the communication setting of DCISoft is Ethernet
	Computer and DTME are in different networks, blocked by network firewall	Please use the specified IP to find the relevant settings

2.7 Initial Power on State

When the DTM has a main station collection function, it enters the initialization state after power on, and the host will collect the setting parameters of each expansion module via the internal communications bus, which will take approximately 30 sec. External communications interfaces (including RS485, USB, Ethernet) will be unable to communicate at this time.

2.7.1 Light Display Status

 PWR (Power): Power light (green light)→ power light [on steadily], indicates that the device is powered up.

 RUN (output Run): Control light (green light)→ control light [on steadily], indicates that control is effective through any one channel.

 COM (Communication): Communications light (green light)→ communications light [flashing], indicates that the host is communicating.

 ERR (Error): Error indicator light (red light)→

Error indicator light [flashing], indicates internal communications error; possible situations:

1. There are more than 7 measurement expansion modules
2. Expansion modules of the same type have the same internal station number
3. Error in reading of measurement expansion module by the host via the internal communications bus

Error indicator light [on steadily], indicates that there is some other error, and the output must be turned off; possible situations:

1. Input temperature value is unstable (any input point)
2. Sensor input line is severed or not connected (any input point)
3. Input sensor error (any input point)
4. Input hardware malfunction (any input point)
5. Memory EEPROM error
6. Input exceeds setting range (any input point)

When the error indicator light comes on, a communication method can be used to inspect the communications content from the corresponding address to determine the error status. The communications address and content are as shown in the following table; the bit number corresponds to the error content, Bit0~7 = 0 = normal; Bit0~7 = 1 = abnormal (see error content in the following table):

Chapter 2: Specifications and System Configuration

	Internal communications error	Other error
	Hx9B8	Hx9B0~Hx9B7 (input channels 1~8)
Bit0	There are more than 7 measurement expansion modules	Input temperature value is unstable (any input point)
Bit1	Main station data collection error	Sensor input line is severed or not connected (any input point)
Bit2	Internal communications line severed	Input sensor error (any input point)
Bit3	Expansion modules of the same type have the same internal station number	Input hardware malfunction (any input point)
Bit4	Communications write error	Memory EEPROM error
Bit5	Communications read error	Input exceeds setting range (any input point)
Bit6	N/A	A program has exceeded wait time (only notifies, does not run)
Bit7	N/A	RTD input short circuit (any input point)

Table – Corresponding error status table

- ❖ *Example: If it is found that the reading of measurement expansion module input channels 3 in internal station number 2 is abnormal, the error indicator light will come on, the command to read address **[H 29B2]** and confirm the situation can be given.*
- ❖ *Notes: x indicates the internal station number of the host or measurement expansion module.*

2.8 Definitions of Commonly Used Terms

Abbreviation	Definition (English)
PV	Present Value
SV	Setpoint Value
OUT	Output
ALM	Alarm
ALM-H	Alarm High
ALM-L	Alarm Low
CT	Current Transformer
TC	Thermocouple
RTD	Resistance Temperature Detector

2.9 Restoring Default Settings

The DTMs default setting values can be restored using the following steps:

Write the content of **[H1234]** to address **[Hx25C]**, and write the content of **[H1357]** to address **[Hx25A]**, turn off power, and turn on power again.

❖ *Notes: x indicates the internal station number of the host or measurement expansion module.*

Chapter 3

Input Function Configuration

3.1 Input Functions

The DTM series allows the setting of input channel type as thermocouple pair, resistance temperature detection, analog voltage input, or analog current input.

3.1.1 Input Function Settings

Hardware connection: (as shown in the following figure and table)

- A. Thermocouple pair (TC): Connect TC-, TC+ to the corresponding contacts
- B. Resistance temperature sensor (RTD): Three-wire connection method: Connect the RTD to the input terminal corresponding to temperature control
- C. Analog voltage (V): Connect the analog voltage V+, V- to the corresponding contacts
- D. Analog current (mA): Connect the analog current I+, I- to the corresponding contacts

Input terminal (from top to bottom)	Input type			
	TC	RTD	V	mA
L1		RTD+		
L2	TC+	RTD-	V+	I+
L3	TC-	RTD-	V-	I-

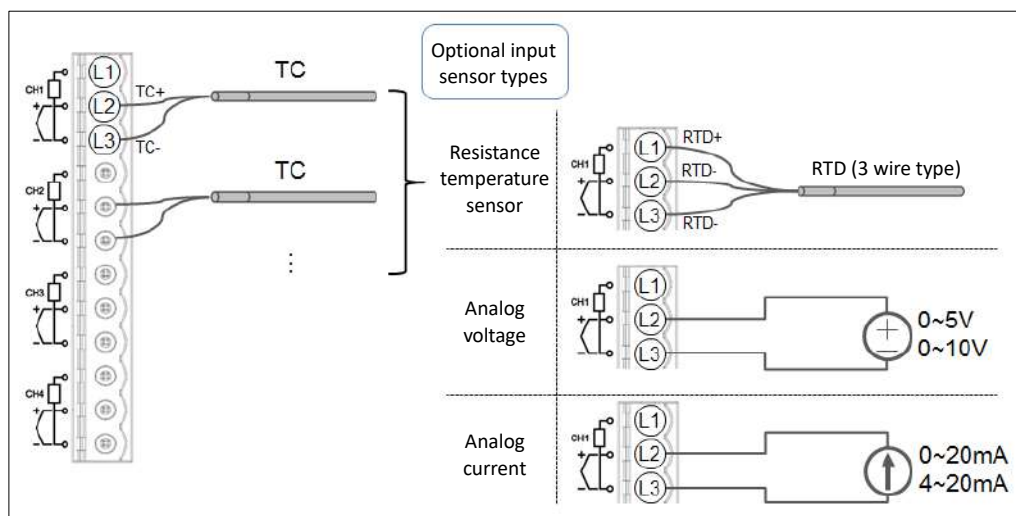

Table - Input terminal definitions and connections

Figure – Schematic diagram of input terminal definitions and connections

Chapter 3: Input Function Configuration

Software settings: (communications addresses are shown in the table below)

A. **Input sensor type:** Write the communications address corresponding to the configured value; the settings must be consistent with the hardware-connected sensors

B. **Input range settings:**

SV high limit: Depending on the input sensor type and range, set the sensors upper limits; the setting may not exceed the upper limit of the input range

SV low limit: Depending on the input sensor type and range, set the sensors lower limits; the setting may not exceed the lower limit of the input range

❖ *Note: Please refer to [Section 3.1.2] for maximum input sensor ranges (default value)*

C. **SV value (R/W):** Makes settings in accordance with the target temperature; the SV may not go beyond the upper or lower limit of the SV configured values

	CH1	CH2	CH3	CH4	CH5	CH6	CH7	CH8
Input sensor type (please refer to the form below for configuring values)	Hx028	Hx029	Hx02A	Hx02B	Hx02C	Hx02D	Hx02E	Hx02F
SV high limit	Hx008	Hx009	Hx00A	Hx00B	Hx00C	Hx00D	Hx00E	Hx00F
SV low limit	Hx010	Hx011	Hx012	Hx013	Hx014	Hx015	Hx016	Hx017
SV value(R/W)	Hx000	Hx001	Hx002	Hx003	Hx004	Hx005	Hx006	Hx007

Table - Input sensors, upper and lower limits, and SV value function communications addresses

❖ *Example: If it is wished to set internal station number 2 for the measurement expansion modules input channel 3 as PT100, write the content [H000C] to address [H202A].*

❖ *Note: x indicates the internal station number of the system or measurement expansion module.*

❖ *R: read; W: write*

3.1.2 Input Type, Range, and Corresponding Communications Content

Configuring values	Input sensor type	Input sensor range (default value)
0	Thermocouple K type	-200 - 1,300°C
1	Thermocouple J type	-100 - 1,200°C
2	Thermocouple T type	-200 - 400°C
3	Thermocouple E type	0 - 600°C
4	Thermocouple N type	-200 - 1,300°C
5	Thermocouple R type	0 - 1,700°C
6	Thermocouple S type	0 - 1,700°C
7	Thermocouple B type	100 - 1,800°C
8	Thermocouple L type	-200 - 850°C
9	Thermocouple U type	-200 - 500°C
10	Thermocouple TXK type	-150 - 800°C
11	Platinum measurement resistance (JPt100)	-20 - 400°C
12	Platinum measurement resistance (Pt100)	-200 - 850°C
13	Resistance temperature sensor	-80 - 300°C

Chapter 3: Input Function Configuration

	(Ni120)	
14	Resistance temperature sensor (Cu50)	-50 - 150°C
15	0V-5V analog input	-999 - 9999
16	0V-10V analog input	-999 - 9999
17	0-20mA analog input	-999 - 9999
18	4-20mA analog input	-999 - 9999
19	0-50mV analog input	-999 - 9999

Table - Input type, range, and the corresponding communications content

❖ Note: The default is a K-type thermocouple pair.

3.1.3 Read the Present Value and Setpoint Value

PV value: Reads the measurement value or error message from each channel (see table below)

SV value (R): Read setpoint value; During programmable control, reads the dynamic configured value

❖ Notes: Please refer to [Chapter 5] concerning programmable control

	CH1	CH2	CH3	CH4	CH5	CH6	CH7	CH8
PV value	Hx268	Hx269	Hx26A	Hx26B	Hx26C	Hx26D	Hx26E	Hx26F
SV value (R)	Hx270	Hx271	Hx272	Hx273	Hx274	Hx275	Hx276	Hx277

Table - PV and SV communications addresses

	Hx268 - Hx26F (input channels 1~8)
Communications content	Description of error message content
H8001	EEPROM cannot write
H8002	Input sensor line is severed or not connected
H8003	ADC read failure
H8004	Internal communications error
H8005	Input error
H8006	Channel disabled
H8007	Input data unstable

Table – Content corresponding to PV error codes

❖ Notes:

1. *x* indicates the internal station number of the system or measurement expansion module.
2. Communications address Hx00 (see Section 3.1.1) can read and write the SV value, but communications address Hx270 can only read the SV value; the latter purpose is to directly read the 16 data starting from Hx268 when the user reads the PV value, you can read the PV value and SV value of all channels together simultaneously.

Chapter 3: Input Function Configuration

3.1.4 Analog Input (Voltage, Current) Applications

When input channels are chosen as having analog voltage or current input, the selected analog input type and range should correspond to the input upper and lower limits of the setting range; After the input measures an analog signal, the system will compare with the setting range before converting the corresponding displayed input value.

Example: If the input channels is chosen to measure **[0~5V analog input]** signal in accordance with the default range between the SV upper and lower limits is **[-999~9999]**; the next step is to make the upper SV setting **[5000]**, and the lower SV setting **[0]**. If the input sensor measures input voltage as **[2.5V]**, the corresponding PV value will be **[2500]**.

According to the calculation formulas listed above:

PV value = (upper limit of SV value - Lower limit of SV value) * (measured input value - analog input lower limit) / (upper limit of analog input - analog input lower limit) + lower limit of SV value.

PV = (5000 - 0) x (2.5 - 0.0) / (5.0 - 0.0) + 0 = 2500

3.2 Temperature Filter and Input Error Setting

3.2.1 Temperature Filter Setting

Because the input signal may be subject to interference from noise, causing the displayed value to be unstable, this device provides a temperature filter function, which has two parameters that users can set. One is the temperature filter factor, which has a setting range of 0-50, where 0 is no filter; the default value is 8. The greater this value, the stronger the filtering effect; and the slower the displayed input value will appear. The other parameter is the temperature filter range, which has a setting range of 1~100, with units consisting of 0.1°C; the default value is 10 (1.0°C), which indicates that input signal noise within 1.0°C will activate the filter. The setting range can be increased when the fluctuations in input noise are large. Adjustments are explained as follows:

- A. **Digital filtering factor:** Adjustment range: 0~50

The calculation formula is: Displayed value = (previous displayed value * n + current present value) / (n+1)

- B. **Digital filtering range:** Adjustment range: 1~100, units: 0.1°C (only applicable when the input sensor type is TC or RTD)

3.2.2 Input Error Setting

Temperature control applications may encounter the problem of temperature difference when the temperature at the measurement location and at the sensor location are different. This device needs customers needs by providing users with the ability to set an input error offset value and gain value. Adjustments are explained as follows:

- A. **Offset:** Setting range: -999~999, units: 0.1°C

The calculation formula is: Displayed value = measured value + (input error adjustment value/10)

Example: The measured value is 25.0°C, the input error adjustment value is 12, and the displayed value is 26.2°C

Chapter 3: Input Function Configuration

B. **Gain:** Setting range: 0~999, units: 0.001 increments

The calculation formula is: Displayed value = measured value * (1 + input error gain value / 1000) + input error adjustment value

Example: The measured value is 25.0°C, input error gain value is 100, and the displayed value is $25.0 * (1 + 100 / 1000) + 0 = 27.5^{\circ}\text{C}$

	CH1	CH2	CH3	CH4	CH5	CH6	CH7	CH8
Digital filtering factor	Hx030	Hx031	Hx032	Hx033	Hx034	Hx035	Hx036	Hx037
Digital filtering range	Hx038	Hx039	Hx03A	Hx03B	Hx03C	Hx03D	Hx03E	Hx03F
Offset	Hx018	Hx019	Hx01A	Hx01B	Hx01C	Hx01D	Hx01E	Hx01F
Gain	Hx020	Hx021	Hx022	Hx023	Hx024	Hx025	Hx026	Hx027

Table - Input filter and temperature compensation function communications addresses

Therefore, when the error amount is fixed at different temperatures, you can directly set the input error offset value; When the error amounts are not the same, at this time, the linearity of the error needs to be calculated first, and the error offset value is input first, and then adjusted by the input error gain value.

❖ *Notes:*

1. *x indicates the internal station number of the system or measurement expansion module.*
2. *Can be used in conjunction with the [temperature calibration] function in the DTM Soft (see detailed information in Appendix C) to automatically obtain the input error offset and gain values using the measured values at two points.*

3.3 Other Input Function Settings

3.3.1 Channel Disabled

The DTM system or measurement expansion modules may disable unused input channels, which will ensure that the error indicator light does not come when unused channels have not been connected with sensors.

(Communications addresses and their content are as shown in the table below; channels correspond to bit numbers: Bit0~7→CH1~8, when 0 = disabled off; 1 = disabled on

Name	Address	CH1	CH2	CH3	CH4	CH5	CH6	CH7	CH8
Channel disable (0: disable, 1: enable)	Hx258	Bit0	Bit1	Bit2	Bit3	Bit4	Bit5	Bit6	Bit7

Chapter 3: Input Function Configuration

3.3.2 Temperature Units

Input channel temperature units may be either °C or °F.

(Communications addresses and their content are as shown in the table below; channels correspond to bit numbers: Bit0~7 → CH1~8, 0 =°F; 1 =°C, formula: °F =°C * 9 / 5 + 32)

Name	Address	CH1	CH2	CH3	CH4	CH5	CH6	CH7	CH8
Temperature scale (0:F, 1:°C)	Hx259	Bit0	Bit1	Bit2	Bit3	Bit4	Bit5	Bit6	Bit7

3.3.3 Cold Junction Compensation Selection

When using a thermocouple sensor, the factory default setting is internal cold contact compensation. The following provides the setting of cold contact compensation as external compensation in special applications.

Correspondence between communication address and content is shown in the following table.

Name	Address	CH1	CH2	CH3	CH4	CH5	CH6	CH7	CH8
Cold junction compensation select ^{*4}	Hx260	<p>Host: H0000: CH1 ~ CH8 are all used internal cold junction compensation (factory default). H0001: CH1 is the external cold junction temperature, and the remaining channels are all used the temperature value of CH1 as the external cold junction compensation. H0002: CH2 is the external cold junction temperature, and the remaining channels are all used the temperature value of CH2 as the external cold junction compensation. H0003: CH3 is the external cold junction temperature, and the remaining channels are all used the value of CH3 as the external cold junction compensation. H0004 = CH4 is the external cold junction temperature, and the remaining channels are all used the temperature value of CH4 as the external cold junction compensation. H0005 = CH5 is the external cold junction temperature, and the remaining channels are all used the temperature of CH5 as the external cold junction compensation. H0006 = CH6 is the external cold junction temperature, and the remaining channels are all used the temperature value of CH6 as the external cold junction compensation. H0007 = CH7 is the external cold junction temperature, and the remaining channels are all used all compensated by using the temperature value of CH7 as the external cold junction. H0008 = CH8 is the external cold junction temperature, and the remaining channels are all used all based on the temperature value of CH8 as the external cold junction compensation.</p> <p>Measurement Expansion module: H0000: CH1 ~ CH8 are all used internal cold junction compensation. (factory default) H0009: CH1 ~ CH8 are all compensated by the external cold junction temperature transmitted from the DTM host.</p>							

Chapter 3: Input Function Configuration

	<p>H0001: CH1 is the external cold junction temperature, and the remaining channels are all used the temperature value of CH1 as the external cold junction compensation.</p> <p>H0002: CH2 is the external cold junction temperature, and the remaining channels are all used the temperature value of CH2 as the external cold junction compensation.</p> <p>H0003: CH3 is the external cold junction temperature, and the remaining channels are all used the value of CH3 as the external cold junction compensation.</p> <p>H0004: CH4 is the external cold junction temperature, and the remaining channels are all used the temperature value of CH4 as the external cold junction compensation.</p> <p>H0005: CH5 is the external cold junction temperature, and the remaining channels are all used the temperature of CH5 as the external cold junction compensation.</p> <p>H0006: CH6 is the external cold junction temperature, and the remaining channels are all used the temperature value of CH6 as the external cold junction compensation.</p> <p>H0007: CH7 is the external cold junction temperature, and the remaining channels are all used compensated by using the temperature value of CH7 as the external cold junction.</p> <p>H0008: CH8 is the external cold junction temperature, and the remaining channels are all used the temperature value of CH8 as the external cold junction compensation.</p>
--	---

- ❖ *Example: to use the CH1 temperature value of host as the external cold junction compensation of other channels, write the content **[H0001]** into the address **[H0260]**. The selection of CH1's input can be PT100 or thermocouple type. x indicates the internal station number of the host or measurement expansion module.*

Chapter 3: Input Function Configuration

3.3.4 Input Channel Status

Reads the status of other functions of the system or measurement expansion module input channels; for example, output of 1 and output of 2 indicate whether the function is on and whether the function is performing self-tuning.

(Communications addresses and their content are as shown in the table below; channel status corresponds to bit number: **0** =the function is off; **1** = the function is active)

	Hx288 - Hx28F (input channels 1~8)
	Corresponding function on/off (1 / 0)
Bit0	Alarm 3
Bit1	Alarm 2
Bit2	°C
Bit3	°F
Bit4	Alarm 1
Bit5	Output 2
Bit6	Output 1
Bit7	Self-tuning

Table - Input channel status

Chapter 4

Output and Alarm Function Configuration

4.1 Output Functions

Outputs consist of control outputs and alarm outputs. Each channel can provide 2 control outputs and 3 alarm outputs.

4.1.1 Explanation of Output Functions

1. Control outputs: Can be set as heating outputs or cooling outputs. If an output is set as a heating output, and another is set as a cooling, dual output control exists
2. alarm outputs: Up to 17 alarm modes can be independently set; please refer to **[Section 4.3]**
 - ❖ *Notes: This device has an output percentage restriction function in PID and manual control (please refer to **[Chapter 5]** for further information concerning control functions). Assuming that maximum output has been restricted to 90% and minimum output to 20%, the calculated control output will be restricted to within a 20%~90% range*

4.1.2 Physical Output Type

1. Control outputs: Relay output, Pulse voltage (0, 12V), analog voltage (0~10V), analog current (4~20mA)
2. alarm outputs: Relay outputs

4.1.3 Output Function Settings

Hardware connections: The corresponding expansion cassette may be selected for the DTM host and measurement expansion modules, or at the corresponding output module selected for an expansion IO expansion module

Software settings: (communications addresses are shown in the table below)

- A. **OUTx control action:** Setting content 0: Heating, 1: Cooling, 2: Channel disabled
- B. **OUTx upper limit:** Lower limit of control output ~ 100%
- C. **OUTx lower limit:** 0% ~ upper limit of control output
- D. **OUTx cycle time:** Setting range: 1~600, units: 0.1 sec, default 50

Chapter 4: Output and Alarm Function Configuration

	CH1	CH2	CH3	CH4	CH5	CH6	CH7	CH8
OUT1 control action	Hx0C8	Hx0C9	Hx0CA	Hx0CB	Hx0CC	Hx0CD	Hx0CE	Hx0CF
OUT2 control action	Hx0D0	Hx0D1	Hx0D2	Hx0D3	Hx0D4	Hx0D5	Hx0D6	Hx0D7
OUT1 upper limit	Hx0E8	Hx0E9	Hx0EA	Hx0EB	Hx0EC	Hx0ED	Hx0EE	Hx0EF
OUT1 lower limit	Hx0F0	Hx0F1	Hx0F2	Hx0F3	Hx0F4	Hx0F5	Hx0F6	Hx0F7
OUT1 cycle time	Hx0F8	Hx0F9	Hx0FA	Hx0FB	Hx0FC	Hx0FD	Hx0FE	Hx0FF
OUT2 upper limit	Hx128	Hx129	Hx12A	Hx12B	Hx12C	Hx12D	Hx12E	Hx12F
OUT2 lower limit	Hx130	Hx131	Hx132	Hx133	Hx134	Hx135	Hx136	Hx137
OUT2 cycle time	Hx138	Hx139	Hx13A	Hx13B	Hx13C	Hx13D	Hx13E	Hx13F

Table - Output control setting communications addresses

❖ Note: x indicates internal station number.

4.2 Assign the Addresses for I/O Expansion Module

In the DTM host and measurement expansion modules, each measurement channel can provide 2 control outputs and 3 alarm outputs. The DTM host and measurement expansion modules can provide physical output points for a maximum of 8 channels (install 2 expansion cassettes); when needed, additional I/O expansion modules can be installed to increase the number of physical output points.

The communications addresses of the physical output points of the DTM host and measurement expansion modules are shown in the table below; edit setting content H00yz in accordance with the internal station number of the I/O expansion module (y: 1~F) and channel number (z: 0~7), and so on, and write to the devices output or alarm communications addresses.

	CH1	CH2	CH3	CH4	CH5	CH6	CH7	CH8
OUT1 to station_x*-channel	Hx190	Hx191	Hx192	Hx193	Hx194	Hx195	Hx196	Hx197
OUT2 to station_x*-channel	Hx198	Hx199	Hx19A	Hx19B	Hx19C	Hx19D	Hx19E	Hx19F
ALM1 to station_x*-channel	Hx1A0	Hx1A1	Hx1A2	Hx1A3	Hx1A4	Hx1A5	Hx1A6	Hx1A7
ALM2 to station_x*-channel	Hx1A8	Hx1A9	Hx1AA	Hx1AB	Hx1AC	Hx1AD	Hx1AE	Hx1AF
ALM3 to station_x*-channel	Hx1B0	Hx1B1	Hx1B2	Hx1B3	Hx1B4	Hx1B5	Hx1B6	Hx1B7

Table – Assignment of communications addresses to I/O expansion modules

❖ Note: x indicates internal station number.

❖ Example: As shown in the figure below, if it is wished to assign the [output 2 of input channel 1] of the measurement expansion module at internal station 2 to [channel 1] of the I/O expansion module of internal station 4, write the content of [H0040] to address [H2198]. Bit7~4: station number; Bit3~0: channel location.

Chapter 4: Output and Alarm Function Configuration

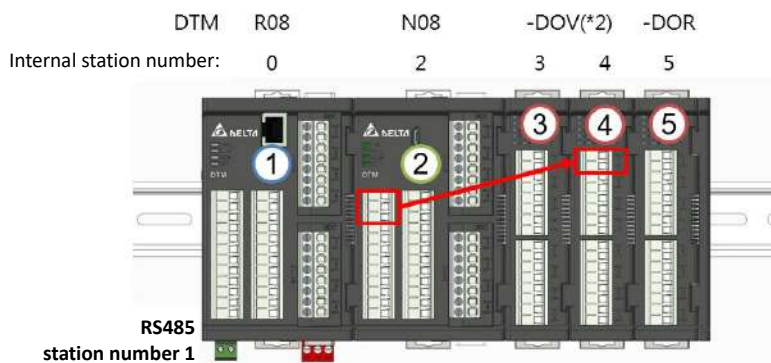

Figure – Schematic diagram of assignment of I/O expansion module locations

❖ *Notes:*

1. *The DTM host and measurement expansion modules come with 8 physical output points (install two expansion cassettes) that can be assigned for use by control output 1.*
2. *Outputs must have an accompanying input; when the input has no signal, the output will have no action.*

4.3 Alarm Functions

Each channel in this device can have 3 alarm outputs.

The 17 alarm modes shown in the table below can be set independently, and alarm delays and 4 alarm functions—standby, output reverse, hold, and record peak—can also be set.

4.3.1 Explanation of Alarm Functions

- A. **Alarm delay:** If setting alarm delay time, when an action complies with the set alarm mode, the controller will delay generation of an alarm signal, and will generate an alarm only after confirming that alarm conditions continue to apply during the delay period
- B. alarm functions - **standby:** In order to prevent the alarm from being activated when power is turned on, alarms will be triggered only when the present value (PV) is within ± 1 increment (temperature: 0.1°C) of the set-point value (SV)
- C. Alarm functions - output **reverse:** The initial state of relay contact is normal open (NO). After activating this function, alarms will be changed to normal closed (NC), and will be returned to a normal open state(NO) if power is cut off to the machine
- D. Alarm functions -**hold:** When an alarm is activated, the alarm signal will continue until the turn-off control is used
- E. alarm functions -**record peak:** Can record the highest or lowest temperature values after the alarm function being set

Chapter 4: Output and Alarm Function Configuration

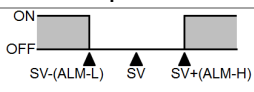
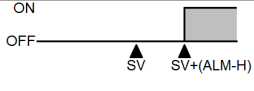
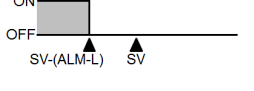
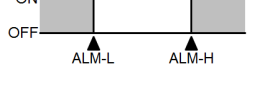
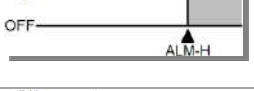
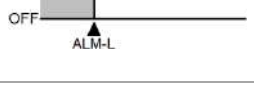
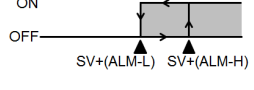
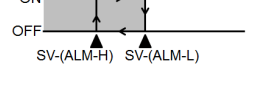
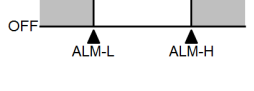
Configuring values	Alarm mode	Alarm output functions
0	No alarm functions	No output action
1	Upper and lower limit alarm actions: When the PV value exceeds $SV + ALM-H$ or is lower than the $SV - ALM-L$ value, the corresponding alarm will be generated.	
2	Upper limit alarm generation: When the PV value exceeds the $SV + ALM-H$ value, the corresponding alarm will be generated.	
3	Lower limit alarm generation: When the PV value is lower than the $SV - ALM-L$ value, the corresponding alarm will be generated.	
4	Absolute value upper and lower limits alarm actions: When the PV value exceeds $ALM-H$ or is lower than the $ALM-L$ value, the corresponding alarm will be generated.	
5	Absolute value upper limit alarm actions: When the PV value exceeds the $ALM-H$ value, the corresponding alarm will be generated.	
6	Absolute value lower limit alarm actions: When the PV value is lower than the $ALM-L$ value, the corresponding alarm will be generated.	
7	Delay upper limit alarm actions: When the PV value exceeds the $SV + ALM-H$ value, the corresponding alarm will be generated. When the PV value is lower than the $SV + ALM-L$ value, corresponding alarm will cease.	
8	Delay lower limit alarm actions: When the PV value is lower than the $SV - ALM-H$ value, the corresponding alarm will be generated. When the PV value is higher than the $SV - ALM-L$ value, the corresponding alarm will cease.	
9	CT1 alarm actions: When the CT1 value is lower than the $ALM-L$ value or is higher than the $ALM-H$ value, the corresponding alarm will be generated.	
10	Programmable Soak (maintain heat) action: When the programmable control is implemented, the corresponding alarm will be generated when in a Soak state.	
11	Programmable Ramp Up action: When the programmable control is implemented, the corresponding alarm will be generated when in a Ramp Up state.	
12	Programmable Ramp Down action: When the programmable control is implemented, the corresponding alarm will be generated when in a Ramp Down state.	
13	Programmable Run action: When the programmable control is implemented, the corresponding alarm will be generated when in a Run state.	
14	Programmable Hold action: When the programmable control is implemented, the corresponding alarm will be generated when in a Hold state.	
15	Programmable Stop action: When the programmable control is implemented, the corresponding alarm will be generated when in a Stop state.	
16	Programmable End action: When the programmable control is implemented, the corresponding alarm will be generated when in a End state.	

Chapter 4: Output and Alarm Function Configuration

Configuring values	Alarm mode	Alarm output functions
17	CT2 alarm actions: When the CT2 value is lower than the ALM-L value or is higher than the ALM-H value, the corresponding alarm will be generated.	

Table – Explanation of alarm mode

4.3.2 Alarm Function Settings

- A. **ALM action:** 17 alarm modes can be available and the mode can be set with writing the configuring values to the corresponding communications address
- B. **ALM-H:** Set the alarm upper limit in accordance with the alarm mode
- C. **ALM-L:** Set the alarm lower limit in accordance with the alarm mode
- D. **ALM delay:** Setting range: 0~100, units: Seconds
- E. **ALM option:** Turns on/turns off corresponding alarm functions in accordance with bit number, Bit0~3 = 0 : off; Bit0~3 = 1 : on
 - Bit0 = standby;
 - Bit1 = output reverse;
 - Bit2 = hold;
 - Bit3 = peak record (reads peak content as shown in the table below)

	CH1	CH2	CH3	CH4	CH5	CH6	CH7	CH8
ALM1 action	Hx040	Hx041	Hx042	Hx043	Hx044	Hx045	Hx046	Hx047
ALM1-H	Hx088	Hx089	Hx08A	Hx08B	Hx08C	Hx08D	Hx08E	Hx08F
ALM1-L	Hx090	Hx091	Hx092	Hx093	Hx094	Hx095	Hx096	Hx097
ALM1 delay	Hx048	Hx049	Hx04A	Hx04B	Hx04C	Hx04D	Hx04E	Hx04F
ALM1 option	Hx050	Hx051	Hx052	Hx053	Hx054	Hx055	Hx056	Hx057
ALM2 action	Hx058	Hx059	Hx05A	Hx05B	Hx05C	Hx05D	Hx05E	Hx05F
ALM2-H	Hx098	Hx099	Hx09A	Hx09B	Hx09C	Hx09D	Hx09E	Hx09F
ALM2-L	Hx0A0	Hx0A1	Hx0A2	Hx0A3	Hx0A4	Hx0A5	Hx0A6	Hx0A7
ALM2 delay	Hx060	Hx061	Hx062	Hx063	Hx064	Hx065	Hx066	Hx067
ALM2 option	Hx068	Hx069	Hx06A	Hx06B	Hx06C	Hx06D	Hx06E	Hx06F
ALM3 action	Hx070	Hx071	Hx072	Hx073	Hx074	Hx075	Hx076	Hx077
ALM3-H	Hx0A8	Hx0A9	Hx0AA	Hx0AB	Hx0AC	Hx0AD	Hx0AE	Hx0AF
ALM3-L	Hx0B0	Hx0B1	Hx0B2	Hx0B3	Hx0B4	Hx0B5	Hx0B6	Hx0B7
ALM3 delay	Hx078	Hx079	Hx07A	Hx07B	Hx07C	Hx07D	Hx07E	Hx07F
ALM3 option	Hx080	Hx081	Hx082	Hx083	Hx084	Hx085	Hx086	Hx087
ALM1 max.	Hx980	Hx981	H982	Hx983	Hx984	Hx985	Hx986	Hx987
ALM1 min.	Hx988	Hx989	Hx98A	Hx98B	Hx98C	Hx98D	Hx98E	Hx98F

Chapter 4: Output and Alarm Function Configuration

ALM2 max.	Hx990	Hx991	Hx992	Hx993	Hx994	Hx995	Hx996	Hx997
ALM2 min.	Hx998	Hx999	Hx99A	Hx99B	Hx99C	Hx99D	Hx99E	Hx99F
ALM3 max.	Hx9A0	Hx9A1	Hx9A2	Hx9A3	Hx9A4	Hx9A5	Hx9A6	Hx9A7
ALM3 min.	Hx9A8	Hx9A9	Hx9AA	Hx9AB	Hx9AC	Hx9AD	Hx9AE	Hx9AF

Table - Alarm function communications addresses

	ALM1 option	ALM2 option	ALM3 option
	Hx050 - Hx057 (channel 1~8)	Hx068 - Hx06F (channel 1~8)	Hx080 - x087 (channel 1~8)
Bit0	Standby (0: off, 1: on)		
Bit1	Output reverse (0: off, 1: on)		
Bit2	Hold (0: off, 1: on)		
Bit3	Peak record (0: off, 1: on)		

Table - Alarm option function settings defined in accordance with communications content

❖ Note: x indicates internal station number.

4.4 Other Output Function Settings

4.4.1 Output Level When Input Sensor Error

When the input sensor is abnormal, the DTM host and the measurement expansion module can be set this parameter to make the corresponding output operate. Users can therefore find out from the output level of specific channels which input channels are in an abnormal state (see [Section 2.7.1] for error status communications addresses).

	CH1	CH2	CH3	CH4	CH5	CH6	CH7	CH8
Sensor fail OUT1 power level	Hx100	Hx101	Hx102	Hx103	Hx104	Hx105	Hx106	Hx107
Sensor fail OUT2 power level	Hx140	Hx141	Hx142	Hx143	Hx144	Hx145	Hx146	Hx147

Table – Assignment of communications addresses to I/O expansion modules

❖ Notes: x indicates the internal station number of the host or measurement expansion module.

Chapter 4: Output and Alarm Function Configuration

4.4.2 Analog Output Compensation Adjustment

When the output type is analog current (4~20mA) or voltage (0~10V), the factory will already have performed calibration procedures. If the client needs to make fine adjustments, it must be fine-tuned by adding or subtracting the previously corrected value.

❖ *Example:*

[Output channel 1] of the expansion cassette DTM-BDC installed on the DTM host must be calibrated for a current range of 3.9~20.5mA. Assuming the original current range was 3.75mA~20.25mA, and the lower limit calibrated value was **[H0032 (50)]** and upper limit calibrated value was **[H00C8 (200)]** at the time of default calibration, analog output compensation will be performed in accordance with the difference:

Analog out lower limit fine tune: $3.9-3.75=0.15\text{mA}$; $0.15\text{mA}/1\mu\text{A}=150$; Because the lower limit was already calibrated at the time of default calibration, the data from the previous calibration must be added when calibration is performed again: $50+150=200$, and the communications content **[H00C8 (200)]** written to **[H0228]**

Analog out upper limit fine tune: $20.5-20.25=0.25\text{mA}$; $0.25\text{mA}/1\mu\text{A}=250$; Because the upper limit was already calibrated at the time of default calibration, the data from the previous calibration must be added when calibration is performed again: $200+250=450$, and the communications content **[H01C2 (450)]** written to **[H02300]**

Analog output current adjustment increment: 1 μ A/scale; Analog output voltage adjustment increment: 1mV/scale (communications addresses are shown in the table below)

	CH1	CH2	CH3	CH4	CH5	CH6	CH7	CH8
Analog out lower limit fine tune(expansion cassette)	Hx228	Hx229	Hx22A	Hx22B	Hx22C	Hx22D	Hx22E	Hx22F
Analog out upper limit fine tune(expansion cassette)	Hx230	Hx231	Hx232	Hx233	Hx234	Hx235	Hx236	Hx237
Analog out lower limit fine tune(I/O expansion module)	Hx789	Hx78A	Hx78B	Hx78C	Hx7C9	Hx7CA	Hx7CB	Hx7CC
Analog out upper limit fine tune(I/O expansion module)	Hx78D	Hx78E	Hx78F	Hx790	Hx7CD	Hx7CE	Hx7CF	Hx7D0

❖ *Notes:*

1. In the communications addresses of expansion cassette in this table, x indicates the internal station number of the DTM host or measurement expansion module in which the expansion cassette has been loaded.
2. In the communications addresses of IO expansion modules in this table, x indicates the I/O expansion modules internal station number.

Chapter 5

Control Functions and Operating Instructions

5.1 Control Functions

This device provides several control modes, including the following: PID, On_Off, programmable PID, Slope control, Automatic/Manual switching.

5.1.1 Explanation of Control Functions

PID:

When set for heating or cooling output, the program will perform PID calculations on the present value (PV) and setpoint value (SV), and output the results of calculations for use in temperature control. When this function is used, PID parameters and a control cycle must be set, or auto-tuning (AT) performed to automatically generate these parameter values.

A. Setting PID parameters and **control cycle**: PID parameters can be manually adjusted in accordance with system characteristics or generated automatically via auto-tuning. The **control cycle** refers to the PID computation cycle; if the control cycle is 10 seconds, one PID value is calculated every 10 seconds, and the result is output for use in temperature control.

❖ *Notes:*

1. *If systems heating rate is fast, the control cycle cannot be set to be too long.*
2. *If the output is a relay output, because of relay service life issues, when the control cycle is too short, it may shorten the relays service life .*

B. Proportional control error compensation: When I parameter is set to 0, the **Output power offset** parameter can be adjusted to reduce the error of temperature control.

C. Dual output: One is the heating output, and the other is the cooling output; these two PID parameters are mutually independent.

ON_OFF:

When set for heating output, if the PV value is greater than the SV value, the output will be **[Off]**; when the PV value is smaller than the (SV value - adjustment sensitivity configured value), the output will be **[On]**.

When set for cooling output, if PV value is greater than the (SV value + adjustment sensitivity configured value), the output will be **[ON]**; when the PV value is smaller than the configured value, the output will be **[Off]**.

If there are two outputs, one can be set as heating, and the other can be set as cooling, which allows a **deadband** to be set (as shown in the figure below). This parameter will be automatically generated when in dual output control. The goal of this operation is to avoid waste of energy from too frequent heating / cooling control.

Chapter 5: Control Functions and Operating Instructions

[100.0°C], and the **deadband** is set as [2.0], this indicates that output will be inactive when the temperature is in a range of [99.0~101.0°C].

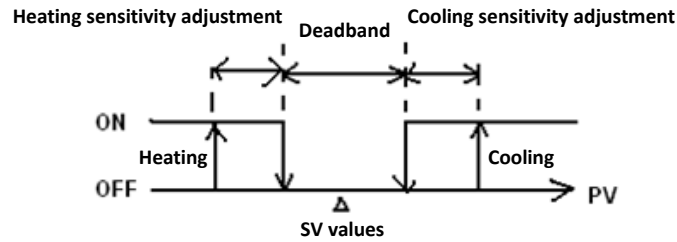

Figure - Dual output heating/cooling deadband

Programmable PID:

Programmable refers to the fact that the SV value is not a fixed value, and PID control can cause the PV to move in accordance with the users temperature setting curve. The following steps can be used to set the temperature curve: The first step is to select one of the 8 patterns provided by this device. Each of these patterns has 8 [steps], and these [steps] can be used to set the desired [Step SV] and [Step time], which will determine the temperature curve and arrival time. Each pattern provides one [linked pattern], [Cycle count], and [End step], which are used to adjust the linkage between different patterns, the number of times a pattern is run, and the maximum number of steps needed for each pattern.

The programmable PID must first set a [Start pattern] and [Start step] before beginning implementation. When the [running time] of the initial step is 0, it is necessary to set an [Start slope] determining the temperature control slope for the temperature increase from room temperature to the initial steps target temperature. The following are definitions and explanations of terms:

- A. **Start pattern:** Setting procedure control implementation begins from what pattern
- B. **Start step:** Setting procedure control implementation begins from what step
- C. **Start slope:** If the time of the initial step of the initial pattern is set as 0, it will be necessary to set an initial slope, which will cause the temperature to rise from room temperature to configure the temperature value
- D. **Steps:** The two parameters **Step SV** X and **Step time** T express that the SV value must rise to temperature X after time T. If the target temperature X is the same as the previous set point, this process is referred to as "Soak." Otherwise, the process is referred to as "Ramp." Accordingly, procedure control is also known as "Ramp Soak" control. The first implementation step is set as Soak as a default. The temperature is first set as the target temperature X, and the temperature is then held at X. The time required for this whole process is T
- E. **Linked pattern:** This refers to the linking to another pattern number after implementation of the first pattern. A setting of 8 ends the program, but the program will maintain the final configured value; a setting of 9 ends all programs, and turns off output
- F. **Cycle count:** This parameter controls the additional rounds of implementation in the pattern; if set as 1, the pattern will be implemented 2 times
- G. **End step:** This parameter controls the number of valid steps in the pattern. If set as 4, the pattern will be implemented until step 4, and any remaining steps will not be implemented,

Chapter 5: Control Functions and Operating Instructions

in which case the system will directly proceed to the next linked pattern or action

- H. **Wait time, Wait SV:** After the programmed temperature curve setting has been completed, the Wait time and Wait SV can be set. When the current measured temperature (PV) is not within a steps ($\text{Step SV} \pm \text{wait SV}$), the **wait time** will be treated as a countdown, and the system will wait until the current measured temperature is within the steps ($\text{Step SV} \pm \text{wait SV}$) before proceeding to the next step. If, after counting down to 0, the current measured temperature is still not within the steps ($\text{Step SV} \pm \text{wait SV}$), and alarm will be generated.
- I. Execution:

When the **Control state** is **Run**, the program will start to execute from the **Start pattern** and **Start step**, and will be executed sequentially.

When the **Control state** is **Stop**, the program stops and the control output is disabled

When the **Control state** is at **Program ends**, the temperature is controlled at the set value before stopping. If it is re-executed, the program will be executed from the set **Start pattern** and **Start step**.

When the **Control state** is **Program pause**, the temperature is controlled at the set value before stopping. If it is re-executed, the program will continue to execute the steps before the stop and the remaining time.

Example: The following settings have been made:

Pattern 0, steps 0 parameters, SV00=30.0, T00 = 1, pattern 1, step 0 parameters, SV10=100.0, T10 = 1

Pattern 0, step 1 parameters, SV01=30.0, T01 = 1, pattern 1, step 1 parameters, SV11=100.0, T11 = 1

Pattern 0, step 2 parameters, SV02=40.0, T02 = 1, pattern 1, step 2 parameters, SV12=60.0, T12 = 1

Pattern 0, step 3 parameters, SV03=40.0, T03 = 1, pattern 1, step 3 parameters, SV13=60.0, T13 = 1

Pattern 0, step 4 parameters, SV04=60.0, T04 = 1, pattern 1, step 4 parameters, SV14=50.0, T14 = 1

Pattern 0, step 5 parameters, SV05=60.0, T05 = 1, pattern 1, step 5 parameters, SV15=50.0, T15 = 1

Pattern 0, step 6 parameters, SV06=80.0, T06 = 1, pattern 1, step 6 parameters, SV16=40.0, T16 = 1

Pattern 0, step 7 parameters, SV07=80.0, T07 = 1, pattern 1, step 7 parameters, SV17=40.0, T17 = 1

Pattern 0 linked pattern is 1, pattern 1 linked pattern 8=end

Pattern 0 number of repetitions 0, pattern 1 number of repetitions 1

Pattern 0 number of valid pattern steps 5, pattern 1 number of valid pattern steps 3

Chapter 5: Control Functions and Operating Instructions

The settings are programmable PID Start pattern 0, and Start step 1, in which case the setting curve will be as follows

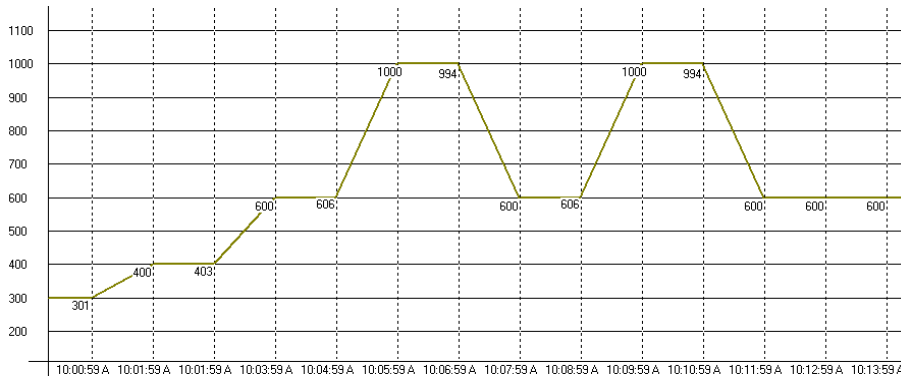

Figure – Example programmable control temperature curve settings

Slope control:

Relying on the already-set SV value, the system will control the temperature increasing slope (units: $0.1^{\circ}\text{C}/\text{min.}$), until the preset temperature is reached.

Example: When the slope is set as 5, and SV is set as 200.0°C , this implies that the temperature will rise at a rate of $0.5^{\circ}\text{C}/\text{min.}$ from room temperature until a temperature of 200.0°C has been reached.

Manual switching:

Switching from automatic control to manual control can force output of a certain percent; when the system was originally under PID control, the following characteristics will be present:

- A. Switching from PID control to manual control: Control output will be maintained as the original operating quantity before switching to manual control. For instance, when the control output before switching resulting from PID calculations is 20%, the control output will continue to be 20% after switching to manual control. Users can force a fixed output value after switching, such as a control output of 40%
 - B. Switching from manual control to PID control: If the output was 40% before switching from manual control to PID control, the program will take 40% as an initial value in PID calculations after switching to PID, and will generate a new control output
- ❖ *Notes: If power to the device is turned off while under manual control status, the original output percent value will be retained after restarting power*

Chapter 5: Control Functions and Operating Instructions

5.1.2 Control Function Settings

PID:

- A. **Automatic control mode:** Configured value setting of 0, 0:PID 1:ON-OFF 2:programmable PID
- B. **OUTx control action:** Configured value can be set as 0: Heating, 1: Cooling, 2: Disabled
- C. **Output control cycle:** Setting range: 1~600, units: 0.1 sec
- D. **Run/stop:** Configured value can be set as 0: Stop, 1: Run
- E. **Auto-tuning:** Configured value can be set as 0: Stop, 1: Run

Note: It is necessary to make sure that the input and output channels are properly connected to the corresponding equipment and measurement and control parameters have been set before performing self-tuning

- F. **Proportional band (P), Integration time (I), Derivative time (D):** PID parameter settings

❖ *Notes:*

1. *If in dual output or cooling output, the cooling side proportional band (P), cooling side integration time (I), and cooling side derivative time (D) must be set*
 2. *These parameters can also be set using auto-tuning*
- G. **% OUTx power (Automatic):** Read the output operating quantity from each PID control cycle
 - H. **Cooling way:** When the selected output control mode is heating/cooling dual output, the cooling method can be set as 0: When the same as heating, 1: linear, 2: air cooling, 3: water cooling

ON_OFF:

- A. **Automatic control mode:** Configured value setting of 1
- B. **OUTx control hysteresis:** Setting range: 0~9999, units: 0.1°C
- C. **Deadband:** Setting range: -999~9999, units: 0.1°C

❖ *Notes: The needed parameters can be written ahead of time, and the system will automatically initiate this function when under dual output control, and use the preset parameters*

Programmable PID:

- A. **Automatic control mode:** Configured value setting of 2
- B. **Run/stop:** Configured value can be set as 0: Stop, 1: Run, 2: End of program, 3: Pause program
- C. **Start pattern:** Setting range: 0~7
- D. **Start step:** Setting range: 0~7
- E. **End step:** Setting range: 0~7
- F. **Cycle count:** Setting range: 0~99
- G. **Linked pattern:** Setting range: 0~7
- H. **Start slope:** Setting range: 0~3000, units: 0.1°C/min
- I. **Wait SV:** Setting range: -999~999, units: 0.1°C
- J. **Wait time:** Setting range: 0~999, units: 1 sec
- K. **Step SV:** Setting range: -2000~18000, units: 0.1°C
- L. **Step time:** Setting range: 0~900, units: 1 sec
- M. **% OUTx power (Automatic):** Read the output operating quantity calculated in each PID

Chapter 5: Control Functions and Operating Instructions

control cycle under programmable control

- N. **Pattern status:** Read current linked pattern number
- O. **Step status:** Read current linked pattern step number
- P. **Number of remaining rounds:** Read currently remaining number of rounds in pattern
- Q. **Current status of program:** Read current state of programmable control implementation.
 On =1; Off=0
 Bit2: End of program and control implementation turns off
 Bit1: Can pause the program
 Bit0: End of program but control implementation continues to the final state
- R. **Remaining time step (sec.):** Read remaining time in current step (sec.)
- S. **Remaining time step (min.):** Read remaining time in current step (min.)

Slope control:

SV ramp rate: Setting range: 0~3000, units: 0.1°C

Manual switching:

- A. **Control mode transfer:** Configured value can be set as 0: automatic, 1: manual
- B. **% OUTx power (Manual):** Setting range: 0~1000, units: 0.1%

❖ *Notes: PID, On/Off, and the programmable PID are all automatic modes*

	CH1	CH2	CH3	CH4	CH5	CH6	CH7	CH8
Automatic control mode	Hx0B8	Hx0B9	Hx0BA	Hx0BB	Hx0BC	Hx0BD	Hx0BE	Hx0BF
Control mode transfer	Hx0C0	Hx0C1	Hx0C2	Hx0C3	Hx0C4	Hx0C5	Hx0C6	Hx0C7
OUT1 control action	Hx0C8	Hx0C9	Hx0CA	Hx0CB	Hx0CC	Hx0CD	Hx0CE	Hx0CF
OUT2 control action	Hx0D0	Hx0D1	Hx0D2	Hx0D3	Hx0D4	Hx0D5	Hx0D6	Hx0D7
PID Group	Hx3E8	Hx3E9	Hx3EA	Hx3EB	Hx3EC	Hx3ED	Hx3EE	Hx3EF
SV ramp rate	Hx3F0	Hx3F1	Hx3F2	Hx3F3	Hx3F4	Hx3F5	Hx3F6	Hx3F7
OUT1 cycle time	Hx0F8	Hx0F9	Hx0FA	Hx0FB	Hx0FC	Hx0FD	Hx0FE	Hx0FF
OUT2 cycle time	Hx138	Hx139	Hx13A	Hx13B	Hx13C	Hx13D	Hx13E	Hx13F
% OUT1 power (Manual)	Hx0E0	Hx0E1	Hx0E2	Hx0E3	Hx0E4	Hx0E5	Hx0E6	Hx0E7
% OUT2 power (Manual)	Hx120	Hx121	Hx122	Hx123	Hx124	Hx125	Hx126	Hx127
Output power offset	Hx170	Hx171	Hx172	Hx173	Hx174	Hx175	Hx176	Hx177
% OUT1 power (Automatic)	Hx278	Hx279	Hx27A	Hx27B	Hx27C	Hx27D	Hx27E	Hx27F
% OUT2 power	Hx280	Hx281	Hx282	Hx283	Hx284	Hx285	Hx286	Hx287

Chapter 5: Control Functions and Operating Instructions

(Automatic)								
Control status	Hx248	Hx249	Hx24A	Hx24B	Hx24C	Hx24D	Hx24E	Hx24F
Auto-tuning	Hx250	Hx251	Hx252	Hx253	Hx254	Hx255	Hx256	Hx257
Proportional band	Hx2E1	Hx2E9	Hx2F1	Hx2F9	Hx301	Hx309	Hx311	Hx319
Integration time	Hx2E2	Hx2EA	Hx2F2	Hx2FA	Hx302	Hx30A	Hx312	Hx31A
Derivative time	Hx2E3	Hx2EB	Hx2F3	Hx2FB	Hx303	Hx30B	Hx313	Hx31B
Cooling side proportional band	Hx2E4	Hx2EC	Hx2F4	Hx2FC	Hx304	Hx30C	Hx314	Hx31C
Cooling side integration time	Hx2E5	Hx2ED	Hx2F5	Hx2FD	Hx305	Hx30D	Hx315	Hx31D
Cooling side derivative time	Hx2E6	Hx2EE	Hx2F6	Hx2FE	Hx306	Hx30E	Hx316	Hx31E
OUT1 control hysteresis	Hx0D8	Hx0D9	Hx0DA	Hx0DB	Hx0DC	Hx0DD	Hx0DE	Hx0DF
OUT2 control hysteresis	Hx118	Hx119	Hx11A	Hx11B	Hx11C	Hx11D	Hx11E	Hx11F
Deadband	Hx178	Hx179	Hx17A	Hx17B	Hx17C	Hx17D	Hx17E	Hx17F
Cooling way	Hx180	Hx181	Hx182	Hx183	Hx184	Hx185	Hx186	Hx187

Table - Control parameter communications addresses

	CH1	CH2	CH3	CH4	CH5	CH6	CH7	CH8
Start pattern	Hx418	Hx419	Hx41A	Hx41B	Hx41C	Hx41D	Hx41E	Hx41F
Start step	Hx420	Hx421	Hx422	Hx423	Hx424	Hx425	Hx426	Hx427
End step	Hx428	Hx429	Hx42A	Hx42B	Hx42C	Hx42D	Hx42E	Hx42F
Cycle count	Hx430	Hx431	Hx432	Hx433	Hx434	Hx435	Hx436	Hx437
Linked pattern	Hx438	Hx439	Hx43A	Hx43B	Hx43C	Hx43D	Hx43E	Hx43F
Start slope	Hx410	Hx411	Hx412	Hx413	Hx414	Hx415	Hx416	Hx417
Wait SV	Hx400	Hx401	Hx402	Hx403	Hx404	Hx405	Hx406	Hx407
Wait time	Hx408	Hx409	Hx40A	Hx40B	Hx40C	Hx40D	Hx40E	Hx40F
Pattern status	Hx290	Hx291	Hx292	Hx293	Hx294	Hx295	Hx296	Hx297
Step status	Hx298	Hx299	Hx29A	Hx29B	Hx29C	Hx29D	Hx29E	Hx29F
Number of remaining rounds (R)	Hx2A0	Hx2A1	Hx2A2	Hx2A3	Hx2A4	Hx2A5	Hx2A6	Hx2A7
Current status of program (R)	Hx2A8	Hx2A9	Hx2AA	Hx2AB	Hx2AC	Hx2AD	Hx2AE	Hx2AF
Step remaining time(sec)	Hx2B0	Hx2B1	Hx2B2	Hx2B3	Hx2B4	Hx2B5	Hx2B6	Hx2B7
Step remaining	Hx2B8	Hx2B9	Hx2BA	Hx2BB	Hx2BC	Hx2BD	Hx2BE	Hx2BF

Chapter 5: Control Functions and Operating Instructions

time(min)									
-----------	--	--	--	--	--	--	--	--	--

Table - Programmable control parameter communications addresses

		Pattern 0	Pattern 1	Pattern 2	Pattern 3	Pattern 4	Pattern 5	Pattern 6	Pattern 7
Step 0 setting	Step0 SV Step0 time	Hx440 Hx441	Hx442 Hx443	Hx444 Hx445	Hx446 Hx447	Hx448 Hx449	Hx44A Hx44B	Hx44C Hx44D	Hx44E Hx44F
Step 1 setting	Step1 SV Step1 time	Hx450 Hx451	Hx452 Hx453	Hx454 Hx455	Hx456 Hx457	Hx458 Hx459	Hx45A Hx45B	Hx45C Hx45D	Hx45E Hx45F
Step 2 setting	Step2 SV Step2 time	Hx460 Hx461	Hx462 Hx463	Hx464 Hx465	Hx466 Hx467	Hx468 Hx469	Hx46A Hx46B	Hx46C Hx46D	Hx46E Hx46F
Step 3 setting	Step3 SV Step3 time	Hx470 Hx471	Hx472 Hx473	Hx474 Hx475	Hx476 Hx477	Hx478 Hx479	Hx47A Hx47B	Hx47C Hx47D	Hx47E Hx47F
Step 4 setting	Step4 SV Step4 time	Hx480 Hx481	Hx482 Hx483	Hx484 Hx485	Hx486 Hx487	Hx488 Hx489	Hx48A Hx48B	Hx48C Hx48D	Hx48E Hx48F
Step 5 setting	Step5 SV Step5 time	Hx490 Hx491	Hx492 Hx493	Hx494 Hx495	Hx496 Hx497	Hx498 Hx499	Hx49A Hx49B	Hx49C Hx49D	Hx49E Hx49F
Step 6 setting	Step6 SV Step6 time	Hx4A0 Hx4A1	Hx4A2 Hx4A3	Hx4A4 Hx4A5	Hx4A6 Hx4A7	Hx4A8 Hx4A9	Hx4AA Hx4AB	Hx4AC Hx4AD	Hx4AE Hx4AF
Step 7 setting	Step7 SV Step7 time	Hx4B0 Hx4B1	Hx4B2 Hx4B3	Hx4B4 Hx4B5	Hx4B6 Hx4B7	Hx4B8 Hx4B9	Hx4BA Hx4BB	Hx4BC Hx4BD	Hx4BE Hx4BF

Table - Programmable step parameter communications addresses

Chapter 5: Control Functions and Operating Instructions

5.2 Multiple-group PID Option Settings

When under PID control, the system provides 4 PID groups and 7 parameters (group SV value, proportional band, integration time, derivative time, cooling side proportional band, cooling side integration time, cooling side derivative time) as setting options for users. Users can use one of the 4 PID groups for system PID control, or let the program automatically select a PID group close to the input configured values to obtain parameters. Because each set of PID parameters contains reference values (SV) for that group, users can use these reference values to perform their own settings or automatically generate settings.

Example: In the 4 sets of PID parameters below, the SV values are the reference input configured values. Users can take the values in the fourth set as the PID parameters, namely P=60, I=200, D=50. If the user chooses to automatically find a set of parameters close to input configured values, when the input configured value is 230, the program will automatically take the third PID group as the operating parameters after performing a comparison.

	Group 1	Group 2	Group 3	Group 4
Group SV value	80	160	240	320
Proportional band	120	47	70	60
Integration time	100	140	180	200
Derivative time	25	35	45	50

Table – Example PID groups

5.2.1 Selection of a PID Group

In accordance with the PID group corresponding to the needed settings, communications configured value settings 0~3 correspond to PID groups 1~4, and communications configured value set as 4 will initiate automatic switching.

	CH1	CH2	CH3	CH4	CH5	CH6	CH7	CH8
PID group	Hx3E8	Hx3E9	Hx3EA	Hx3EB	Hx3EC	Hx3ED	Hx3EE	Hx3EF

Table - PID group switching communications addresses

5.2.2 Group Parameter Settings

Parameter can be individually input by customer in accordance with their communications addresses, or can be generated automatically via AT.

Example: Selecting group 2 as the parameters to be implemented, when AT is completed, the PID values will be added to the corresponding addresses in group 2, and the SV values are added to the SV values of group 2

Name	Description	CH1	CH2	CH3	CH4	CH5	CH6	CH7	CH8
PID Group1 SV	unit: 0.1	Hx500	Hx508	Hx510	Hx518	Hx520	Hx528	Hx530	Hx538
PID Group1 proportional band	unit: 0.1 range: 0 ~ 9,999	Hx501	Hx509	Hx511	Hx519	Hx521	Hx529	Hx531	Hx539
PID Group1	range: 0 ~ 9,999	Hx502	Hx50A	Hx512	Hx51A	Hx522	Hx52A	Hx532	Hx53A

Chapter 5: Control Functions and Operating Instructions

Name	Description	CH1	CH2	CH3	CH4	CH5	CH6	CH7	CH8
integral time									
PID Group1 derivative time	range: 0 ~ 9,999	Hx503	Hx50B	Hx513	Hx51B	Hx523	Hx52B	Hx533	Hx53B
PID Group1 cooling proportional band	unit: 0.1 range: 0 ~ 9,999	Hx504	Hx50C	Hx514	Hx51C	Hx524	Hx52C	Hx534	Hx53C
PID Group1 cooling integral time	range: 0 ~ 9,999	Hx505	Hx50D	Hx515	Hx51D	Hx525	Hx52D	Hx535	Hx53D
PID Group1 cooling derivative time	range: 0 ~ 9,999	Hx506	Hx50E	Hx516	Hx51E	Hx526	Hx52E	Hx536	Hx53E
Reservation 1		Hx507	Hx50F	Hx517	Hx51F	Hx527	Hx52F	Hx537	Hx53F
PID Group2 SV	unit: 0.1	Hx540	Hx548	Hx550	Hx558	Hx560	Hx568	Hx570	Hx578
PID Group2 proportional band	unit: 0.1 range: 0 ~ 9,999	Hx541	Hx549	Hx551	Hx559	Hx561	Hx569	Hx571	Hx579
PID Group2 integral time	range: 0 ~ 9,999	Hx542	Hx54A	Hx552	Hx55A	Hx562	Hx56A	Hx572	Hx57A
PID Group2 derivative time	range: 0 ~ 9,999	Hx543	Hx54B	Hx553	Hx55B	Hx563	Hx56B	Hx573	Hx57B
PID Group2 cooling proportional band	unit: 0.1 range: 0 ~ 9,999	Hx544	Hx54C	Hx554	Hx55C	Hx564	Hx56C	Hx574	Hx57C
PID Group2 cooling integral time	range: 0 ~ 9,999	Hx545	Hx54D	Hx555	Hx55D	Hx565	Hx56D	Hx575	Hx57D
PID Group2 cooling derivative time	range: 0 ~ 9,999	Hx546	Hx54E	Hx556	Hx55E	Hx566	Hx56E	Hx576	Hx57E
Reservation 2		Hx547	Hx54F	Hx557	Hx55F	Hx567	Hx56F	Hx577	Hx57F
PID Group3 SV	unit: 0.1	Hx580	Hx588	Hx590	Hx598	Hx5A0	Hx5A8	Hx5B0	Hx5B8
PID Group3 proportional band	unit: 0.1 range: 0 ~ 9,999	Hx581	Hx589	Hx591	Hx599	Hx5A1	Hx5A9	Hx5B1	Hx5B9
PID Group3 integral time	range: 0 ~ 9,999	Hx582	Hx58A	Hx592	Hx59A	Hx5A2	Hx5AA	Hx5B2	Hx5BA
PID Group3 derivative time	range: 0 ~ 9,999	Hx583	Hx58B	Hx593	Hx59B	Hx5A3	Hx5AB	Hx5B3	Hx5BB
PID Group3 cooling proportional band	unit: 0.1 range: 0 ~ 9,999	Hx584	Hx58C	Hx594	Hx59C	Hx5A4	Hx5AC	Hx5B4	Hx5BC
PID Group3 cooling integral time	range: 0 ~ 9,999	Hx585	Hx58D	Hx595	Hx59D	Hx5A5	Hx5AD	Hx5B5	Hx5BD
PID Group3	range: 0 ~ 9,999	Hx586	Hx58E	Hx596	Hx59E	Hx5A6	Hx5AE	Hx5B6	Hx5BE

Chapter 5: Control Functions and Operating Instructions

Name	Description	CH1	CH2	CH3	CH4	CH5	CH6	CH7	CH8
cooling derivative time									
Reservation 3		Hx587	Hx58F	Hx597	Hx59F	Hx5A7	Hx5AF	Hx5B7	Hx5BF
PID Group4 SV	unit: 0.1	Hx5C0	Hx5C8	Hx5D0	Hx5D8	Hx5E0	Hx5E8	Hx5F0	Hx5F8
PID Group4 proportional band	unit: 0.1 range: 0 ~ 9,999	Hx5C1	Hx5C9	Hx5D1	Hx5D9	Hx5E1	Hx5E9	Hx5F1	Hx5F9
PID Group4 integral time	range: 0 ~ 9,999	Hx5C2	Hx5CA	Hx5D2	Hx5DA	Hx5E2	Hx5EA	Hx5F2	Hx5FA
PID Group4 derivative time	range: 0 ~ 9,999	Hx5C3	Hx5CB	Hx5D3	Hx5DB	Hx5E3	Hx5EB	Hx5F3	Hx5FB
PID Group4 cooling proportional band	unit: 0.1 range: 0 ~ 9,999	Hx5C4	Hx5CC	Hx5D4	Hx5DC	Hx5E4	Hx5EC	Hx5F4	Hx5FC
PID Group4 cooling integral time	range: 0 ~ 9,999	Hx5C5	Hx5CD	Hx5D5	Hx5DD	Hx5E5	Hx5ED	Hx5F5	Hx5FD
PID Group4 cooling derivative time	range: 0 ~ 9,999	Hx5C6	Hx5CE	Hx5D6	Hx5DE	Hx5E6	Hx5EE	Hx5F6	Hx5FE

Table - PID group switching communications addresses

Chapter 6

Operating Instructions for Other Auxiliary Functions

6.1 Self-definition of Functions (Default)

6.1.1 Explanation of Self-definition of Functions (Default)

Self-definition of functions (default) refers to the placement of functions commonly used together in the same communications group. To define different functions in different communications groups (a total of 16 groups, see table below), users can first select the needed communications group, then enter the internal station number and channel of the data content to be read into the communications groups first address, and finally read relevant single/multiple function data content items.

6.1.2 Settings for Self-definition of Functions (Default)

- ❖ *Example: To write the input channel_2 PID control parameters for the measurement expansion module with internal station number 4 in accordance with [30, 160, 40] (H001E, H00A0, H0028), first select [communications group 0] (H0A00~H0A0F) in accordance with needs, and then write data content [H0041] of internal station number and channel to [H0A00], which will allow the content of [H001E, H00A0, H0028] to be written to [H0A01, H0A02, H0A03] in multiple items; reading is performed in the same way.*
- ❖ *Notes: Internal station number and channels can be edited by setting the content of H00yz in accordance with internal station number (y: 1~F) and channel number (z: 0~7).*

Group 0	H0A00-H0A07	Internal station number/channel	Proportional band	Integration time	Derivative time	Proportional band (cooling side)	Integration time (cooling side)	Derivative time (cooling side)	Reserved area
	H0A08-H0A0F	Reserved area	Reserved area	Reserved area	Reserved area	Group SV value	Reserved area	Reserved area	Reserved area
Group 1	H0A10-H0A17	Internal station number/channel	SV value	Upper limit of SV value	Lower limit of SV value	Input Offset value	Input Gain value	Input sensor type	Digital filtering factor
	H0A18-H0A1F	Digital filtering range	Reserved area	Reserved area	Reserved area	Reserved area	Reserved area	Reserved area	Reserved area

Chapter 6: Operating Instructions for Other Auxiliary Functions

Group 2	H0A20-H0A27	Internal station number/channel	ALM1 action	ALM1 Delay	ALM1 option	ALM1-H	ALM1-L	ALM2 action	ALM2 Delay
	H0A28-H0A2F	ALM2 option	ALM2-H	ALM2-L	ALM3 action	ALM3 Delay	ALM3 option	ALM3-H	ALM3-L
Group 3	H0A30-H0A37	Internal station number/channel	Automatic control mode	Control mode transfer	OUT1 control action	OUT2 control action	Reserved area	Reserved area	Reserved area
	H0A38-H0A3F	Reserved area	Reserved area	Reserved area	Reserved area	Reserved area	Reserved area	Reserved area	Reserved area
Group 4	H0A40-H0A47	Internal station number/channel	OUT1 control hysteresis	% OUT1 power (Manual)	OUT1 upper limit	OUT1 lower limit	OUT1 cycle time	Sensor fail OUT1 power level	Reserved area
	H0A48-H0A4F	Reserved area	Reserved area	Reserved area	Reserved area	Reserved area	Reserved area	Reserved area	Reserved area
Group 5	H0A50-H0A57	Internal station number/channel	OUT2 control hysteresis	% OUT2 power (Manual)	OUT2 upper limit	OUT2 lower limit	OUT2 cycle time	Sensor fail OUT2 power level	Reserved area
	H0A58-H0A5F	Reserved area	Reserved area	Reserved area	Reserved area	Reserved area	Reserved area	Reserved area	Reserved area
Group 6	H0A60-H0A67	Internal station number/channel	Output power offset	Deadband	Cooling way	Reserved area	CT1 value	CT2 value	Reserved area
	H0A68-H0A6F	Reserved area	Reserved area	Reserved area	Reserved area	Reserved area	Reserved area	Reserved area	Reserved area
Group 7	H0A70-H0A77	Internal station number/channel	Output 1 Internal station number	Output 2 Internal station number	Alarm 1 Internal station number	Alarm 2 Internal station number	Alarm 3 Internal station number	Reserved area	CT1 Internal station number
	H0A78-H0A7F	CT2 Internal station number	Reserved area	Reserved area	Reserved area	Reserved area	Reserved area	Reserved area	Reserved area
Group 8	H0A80-H0A87	Internal station number/channel	auto-tuning	Run/stop	Reserved area	Reserved area	Reserved area	Reserved area	Reserved area
	H0A88-H0A8F	Reserved area	Reserved area	Reserved area	Reserved area	Reserved area	Reserved area	Reserved area	Reserved area

Chapter 6: Operating Instructions for Other Auxiliary Functions

Group 9	H0A90-H0A97	Internal station number/channel	Temperature units	Cold junction compensation selection	Channel disabled	Reserved area	Reserved area	Reserved area	Reserved area
	H0A98-H0A9F	Reserved area	Reserved area	Reserved area	Reserved area	Reserved area	Reserved area	Reserved area	Reserved area
Group 10	H0AA0-H0AA7	Internal station number/channel	Reserved area	Reserved area	Reserved area	Reserved area	Reserved area	Reserved area	Reserved area
	H0AA8-H0AAF	Reserved area	Reserved area	Reserved area	Reserved area	Reserved area	Reserved area	Reserved area	Reserved area
Group 11	H0AB0-H0AB7	Internal station number/channel	Reserved area	Reserved area	Reserved area	Reserved area	Reserved area	Reserved area	Reserved area
	H0AB8-H0ABF	Reserved area	Reserved area	Reserved area	Reserved area	Reserved area	Reserved area	Reserved area	Reserved area
Group 12	H0AC0-H0AC7	Internal station number/channel	Proportional band (Group 1)	Integration time (Group 1)	Derivative time (Group 1)	Proportional band (cooling side) (Group 1)	Integration time (cooling side) (Group 1)	Derivative time (cooling side) (Group 1)	Reserved area
	H0AC8-H0ACF	Reserved area	Reserved area	Reserved area	Reserved area	Group SV value (Group 1)	Reserved area	Reserved area	Reserved area
Group 13	H0AD0-H0AD7	Internal station number/channel	Proportional band (Group 2)	Integration time (Group 2)	Derivative time (Group 2)	Proportional band (cooling side) (Group 2)	Integration time (cooling side) (Group 2)	Derivative time (cooling side) (Group 2)	Reserved area
	H0AD8-H0ADF	Reserved area	Reserved area	Reserved area	Reserved area	Group SV value (Group 2)	Reserved area	Reserved area	Reserved area
Group 14	H0AE0-H0AE7	Internal station number/channel	Proportional band (Group 3)	Integration time (Group 3)	Derivative time (Group 3)	Proportional band (cooling side) (Group 3)	Integration time (cooling side) (Group 3)	Derivative time (cooling side) (Group 3)	Reserved area
	H0AE8-	Reserved area	Reserved area	Reserved area	Reserved area	Group SV value	Reserved area	Reserved area	Reserved area

Chapter 6: Operating Instructions for Other Auxiliary Functions

	H0AEF	area			area	(Group 3)	area		
Group 15	H0AF0-H0AF7	Internal station number/channel	Proportional band (Group 4)	Integration time (Group 4)	Derivative time (Group 4)	Proportional band (cooling side) (Group 4)	Integration time (cooling side) (Group 4)	Derivative time (cooling side) (Group 4)	Reserved area
	H0AF8-H0AFF	Reserved area	Reserved area	Reserved area	Reserved area	Group SV value (Group 4)	Reserved area	Reserved area	Reserved area

Table -Self-definition of function (default) communication addresses

Chapter 6: Operating Instructions for Other Auxiliary Functions

6.2 Self-definition of Functions (Self-defined)

6.2.1 Explanation of self-definition of functions (self-defined)

The self-definition of functions (self-defined) refers to placement of the communication addresses of data content that the user needs to read and to write in a system-designated communications block (H0C00~H1CFF) in accordance with the users needs, and then reading and writing the needed data content from that communications block (H0B00~H1BFF).

H0C00~H1CFF ↔ H0B00~H1BFF = communication address definition block ↔ data content reading and writing block

- ❖ *Notes: The communication addresses to be read and written must be first placed in the communication address definition block, which will allow the system to read and to write the data content on the basis of the read communication addresses.*

6.2.2 Settings for Self-definition of Functions (Self-defined)

- A. Communication address definition block: First add the communication addresses to be read and written to **[H0C00~H1CFF]**
- ❖ *Example: As shown in the figure below, the PV value of input channel 1 of station number 0 is **[H0268]**, the PV value of input channel 2 of station number 1 is **[H1269]**, and the SV value of input channel 1 of station number 2 is **[H2270]**; before self-definition of functions, the PC (host computer) must use multiple commands to get the desired data. Users can in advance arrange to write **[H0268]** to **[H0C00]**, write **[H1269]** to **[H0C01]**, and write **[H2270]** to **[H0C02]** to use a single command to get these data late.*
- B. Read/write data content: In accordance with the foregoing communication addresses **[H0C00~H1CFF]** and the corresponding communications areas **[H0B00~H1BFF]**, read and write the data content of the already-established communication addresses
- ❖ *Example: As in the example above, when the communication addresses have been written to **[H0C00, H0C01, H0C02]**, find the corresponding communication addresses **[H0B00, H0B01, H0B02]**, then you can use a single command to read and write the required data content at one time.*

Chapter 6: Operating Instructions for Other Auxiliary Functions

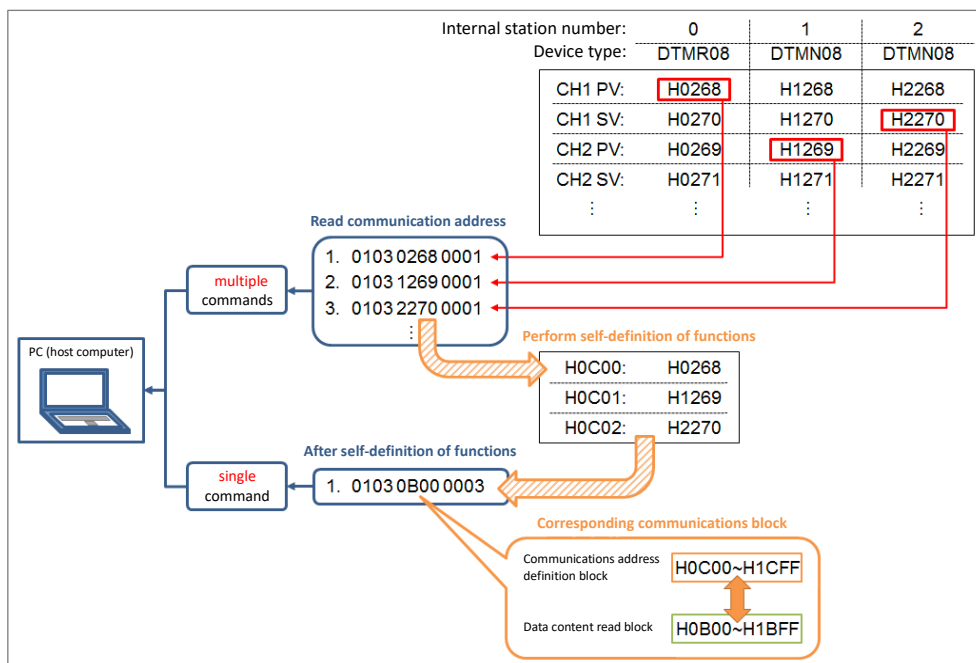

Figure -Schematic diagram of self-definition of functions (self-defined)

6.3 CT Alarm Functions

6.3.1 Explanation of CT Alarm Functions

Each channel in the DTM system and measurement expansion modules provides two CTs (CT1, CT2); When a user wishes to use CT functions, there are two methods that can be used to check the current: The first method consists of directly performing CT current detect of the corresponding station number CT module (see item g. in Section 6.3.2). This method can only read the dynamic CT current value, and cannot deal with alarm functions; The second method consists of using a measurement device to perform current detect (see items c. and d. in Section 6.3.2). First set the input channel corresponding to the CT, but the output channel must be used when the CT is in use. The CT will be able to detect the current only when the output channel is ON. Because a measurement device is used in this method, it can detect whether the CT current exceeds the preset alarm range when alarm functions have been set; if the current exceeds the alarm range, the alarm will be activated.

- ❖ *Notes: The reason the second method [can only read the current value when the output channel is ON] is because the purpose of using CT when alarms are set is to determine the level of the current in the temperature control equipment, and not just to detect the current.*

Chapter 6: Operating Instructions for Other Auxiliary Functions

6.3.2 CT Alarm Function Settings

- A. Setting CT alarms: Please refer to alarm mode setting 9 (CT1) or 17 (CT2) in [Section 4.3]
- B. CT alarm output upper/lower limits: Please refer to [Section 4.3], setting units are 0.1A
- C. CT1 & CT2 use settings: (using measurement device)

There are restrictions on the use of CT. First, the input channel corresponding to a CT must be set first, and further setting performed in accordance with the output of that input channel. Furthermore, CT1 and CT2 may differ due to their output device types; the following is a detailed introduction:

1. CT1 is used in conjunction with output 1. At that time output 1 must be set as an expansion cassette, and the station number of DTM-CT030 corresponding to CT1 can be 1~F.
2. CT2 is used in conjunction with output 2. At that time, output 2 can be set as an expansion cassette or IO expansion module. When output 2 is set as an IO expansion module, CT2 will correspond to DTM-CT030, which must be the same as the IO expansion module station number of output 2, and must be placed in the 9~F area; However, when output 2 is configured as an expansion cassette (typically employed in measurement devices with 4 channels), then both CT2 and CT1 may be simultaneously set as the same DTM-CT030, and the station number settings should be 1~F (refer to the example application shown in the figure below).

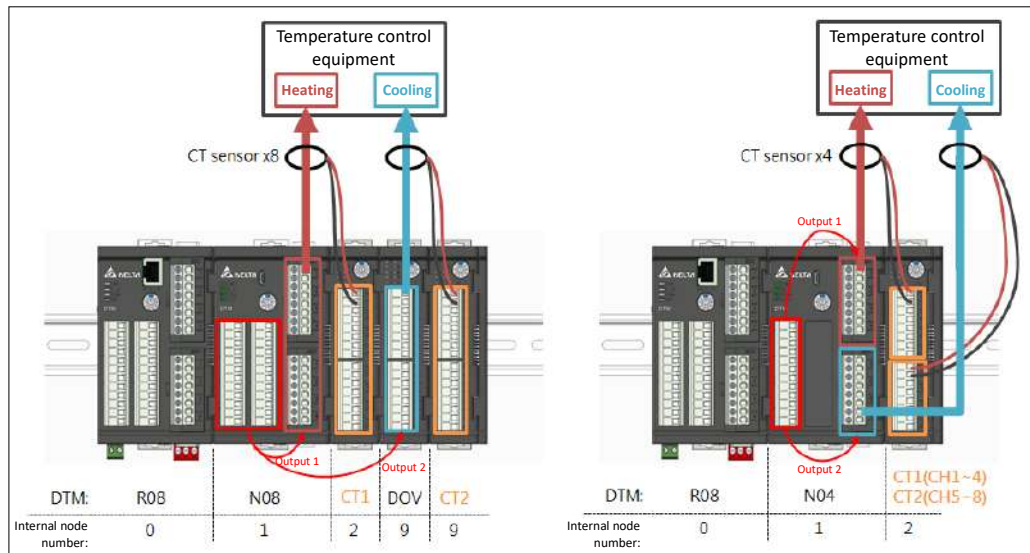

Figure - Schematic diagram of CT use (in the left figure, CT2s output 2 is an IO expansion module; in the right figure, CT2s output 2 is an expansion cassette)

- D. Designated CT channels: (communication addresses are shown in the table below)
- Depending on the DTM host or measurement expansion module to be assigned, in accordance with the internal station number (y: 1~F) and channel (z: 0~7), write the content of H00yz to the corresponding communication address

Chapter 6: Operating Instructions for Other Auxiliary Functions

- ❖ Example: When CT1 is desired to assign the DTM-CT030 [channels 1] of internal station number 4 to the measurement expansion module [output 1 of input channel 1] of internal station number 2, write the content of [H0040] to address [H21C0].

	CH1	CH2	CH3	CH4	CH5	CH6	CH7	CH8
CT1 to station-channel	Hx1C0	Hx1C1	Hx1C2	Hx1C3	Hx1C4	Hx1C5	Hx1C6	Hx1C7
CT2 to station-channel	Hx1C8	Hx1C9	Hx1CA	Hx1CB	Hx1CC	Hx1CD	Hx1CE	Hx1CF

Table -Self-definition of function (default) communication addresses

E. CT sensor mode:

By default, each channel of the DTM-CT030 is used in conjunction with a 30A CT. If a 100A CT must be used, content must be written to the corresponding communication address.

(Communication addresses and their content are as shown in the table below; channels correspond to bit numbers Bit0~7→CH1~8, 0 = 30A; 1 = 100A)

- ❖ Example: If **CH1**, **CH3**, **CH5** of DTM-CT030 with internal station number 6 must be used with a 100A CT, the content of [H0015] must be written to address [H6841].

		CH1	CH2	CH3	CH4	CH5	CH6	CH7	CH8
CT sensor mode	Hy841	Bit0	Bit1	Bit2	Bit3	Bit4	Bit5	Bit6	Bit7

Table –Communications content of CT mode settings

- ❖ Notes: y is the internal station number of DTM-CT030.

F. Read the CT alarm current value: (communication addresses are shown in the table below)

In accordance with the DTM host or measurement expansion module corresponding to the CT channel, when output is ON, measure the CT alarm current value; When the output has been OFF, retain the CT alarm current value from when the output was ON.

	CH1	CH2	CH3	CH4	CH5	CH6	CH7	CH8
CT1 value	Hx2C8	Hx2C9	Hx2CA	Hx2CB	Hx2CC	Hx2CD	Hx2CE	Hx2CF
CT2 value	Hx2D0	Hx2D1	Hx2D2	Hx2D3	Hx2D4	Hx2D5	Hx2D6	Hx2D7

Table - Read the CT current value communication address in accordance with the internal station number of the DTM host or measurement expansion module

- ❖ Notes: x is the internal station number of the DTM host or measurement expansion module corresponding to the CT.
- ❖ The unit of CT1/ CT2 value is 0.1A.

Chapter 6: Operating Instructions for Other Auxiliary Functions

G. CT current value when output is ON or OFF: (communication addresses are shown in the table below)

Read the current value of the corresponding channel according to the internal station number of DTM-CT030. The user can decide to read the value when the output is on or off.

Wish to read the CT value when output is ON: First set the content of communication address H0262 as 0, and then read Hy2C0~Hy2C7 to obtain the CT value when output is ON

Reading the CT value when output is OFF: First set the content of communication address H0262 as 1, and then read Hy2C0~Hy2C7 to obtain the CT value when output is OFF

	CH1	CH2	CH3	CH4	CH5	CH6	CH7	CH8
CT current when OUT being ON or OFF	Hy2C0	Hy2C1	Hy2C2	Hy2C3	Hy2C4	Hy2C5	Hy2C6	Hy2C7

Table - Reading CT current value communication addresses in accordance with DTM-CT030 internal station numbers

❖ *Notes:*

1. *y is the internal station number of the DTM-CT030.*
2. *When reading the CT value with output [OFF], if the output changes to [ON], the communications content will still preserve the original CT current value when [OFF], and the CT value will not be refreshed until output again changes to [OFF], and vice versa.*

Chapter 7

Appendix

7.1 RS485 & Ethernet Communications

7.1.1 Comm. commands for DTM Host and Measurement Expansion Module

1. Before turning on power to the DTM host, first set dip switches, station number addresses, and all attribute expansion module station number addresses.
2. Function code (Function): H03 = read the register content, up to 64 words; H06 = write a word to the register; H10 = write multiple words to the register, up to 64 words.

See the table below for communications function addresses and their content: (x represents the internal station number, x=0 indicates the DTM host)

Name	Description	CH1	CH2	CH3	CH4	CH5	CH6	CH7	CH8
SV(R/W)	unit: 01	Hx000	Hx001	Hx002	Hx003	Hx004	Hx005	Hx006	Hx007
SV high limit	Range: SV low limit~ Input high limit	Hx008	Hx009	Hx00A	Hx00B	Hx00C	Hx00D	Hx00E	Hx00F
SV low limit	range: Input low limit~ SV high limit	Hx010	Hx011	Hx012	Hx013	Hx014	Hx015	Hx016	Hx017
Input Offset	Unit: 0.1°C range: -999 ~ +999	Hx018	Hx019	Hx01A	Hx01B	Hx01C	Hx01D	Hx01E	Hx01F
Input Gain	range: -999 ~ +999	Hx020	Hx021	Hx022	Hx023	Hx024	Hx025	Hx026	Hx027
Input sensor type	Corresponding to input sensor type	Hx028	Hx029	Hx02A	Hx02B	Hx02C	Hx02D	Hx02E	Hx02F
Digital filtering factor	range: 0 ~ 50 default:8	Hx030	Hx031	Hx032	Hx033	Hx034	Hx035	Hx036	Hx037
Digital filtering range	unit: 0.1°C range: 1 ~ 100 default: 10 (1.0°C)	Hx038	Hx039	Hx03A	Hx03B	Hx03C	Hx03D	Hx03E	Hx03F
ALM1 action	refer to Chapter 4	Hx040	Hx041	Hx042	Hx043	Hx044	Hx045	Hx046	Hx047
ALM1 delay	unit: 1s range: 0~100	Hx048	Hx049	Hx04A	Hx04B	Hx04C	Hx04D	Hx04E	Hx04F

Chapter 7:Appendix

Name	Description	CH1	CH2	CH3	CH4	CH5	CH6	CH7	CH8
ALM1 option	Bit3: PV peak value Bit2: hold Bit1: invert Bit0: standby	Hx050	Hx051	Hx052	Hx053	Hx054	Hx055	Hx056	Hx057
ALM2 action	refer to Chapter 4	Hx058	Hx059	Hx05A	Hx05B	Hx05C	Hx05D	Hx05E	Hx05F
ALM2 delay	unit: 1s range: 0~100	Hx060	Hx061	Hx062	Hx063	Hx064	Hx065	Hx066	Hx067
ALM2 option	Bit3: PV peak value Bit2: hold Bit1: invert Bit0: standby	Hx068	Hx069	Hx06A	Hx06B	Hx06C	Hx06D	Hx06E	Hx06F
ALM3 action	refer to Chapter 4	Hx070	Hx071	Hx072	Hx073	Hx074	Hx075	Hx076	Hx077
ALM3 delay	unit: 1s range: 0~100	Hx078	Hx079	Hx07A	Hx07B	Hx07C	Hx07D	Hx07E	Hx07F
ALM3 option	Bit3: PV peak value Bit2: hold Bit1: invert Bit0: standby	Hx080	Hx081	Hx082	Hx083	Hx084	Hx085	Hx086	Hx087
ALM1-H	Alarm when temperature over upper limit	Hx088	Hx089	Hx08A	Hx08B	Hx08C	Hx08D	Hx08E	Hx08F
ALM1-L	Alarm when temperature under lower limit	Hx090	Hx091	Hx092	Hx093	Hx094	Hx095	Hx096	Hx097
ALM2-H	Alarm when temperature over upper limit	Hx098	Hx099	Hx09A	Hx09B	Hx09C	Hx09D	Hx09E	Hx09F
ALM2-L	Alarm when temperature under lower limit	Hx0A0	Hx0A1	Hx0A2	Hx0A3	Hx0A4	Hx0A5	Hx0A6	Hx0A7
ALM3-H	Alarm when temperature over upper limit	Hx0A8	Hx0A9	Hx0AA	Hx0AB	Hx0AC	Hx0AD	Hx0AE	Hx0AF
ALM3-L	Alarm when temperature under lower limit	Hx0B0	Hx0B1	Hx0B2	Hx0B3	Hx0B4	Hx0B5	Hx0B6	Hx0B7
Automatic control mode	0: PID 1: ON-OFF	Hx0B8	Hx0B9	Hx0BA	Hx0BB	Hx0BC	Hx0BD	Hx0BE	Hx0BF

Name	Description	CH1	CH2	CH3	CH4	CH5	CH6	CH7	CH8
	2: programmable PID								
Control mode transfer	0: Automatic 1: Manual	Hx0C0	Hx0C1	Hx0C2	Hx0C3	Hx0C4	Hx0C5	Hx0C6	Hx0C7
OUT1 control action	0: heating(default) 1: cooling	Hx0C8	Hx0C9	Hx0CA	Hx0CB	Hx0CC	Hx0CD	Hx0CE	Hx0CF
OUT2 control action	0: heating(default) 1: cooling	Hx0D0	Hx0D1	Hx0D2	Hx0D3	Hx0D4	Hx0D5	Hx0D6	Hx0D7
OUT1 control hysteresis	unit: 0.1(PV unit) range: 0 ~ 9,999	Hx0D8	Hx0D9	Hx0DA	Hx0DB	Hx0DC	Hx0DD	Hx0DE	Hx0DF
% OUT1 power (Manual)	unit: 0.1 %	Hx0E0	Hx0E1	Hx0E2	Hx0E3	Hx0E4	Hx0E5	Hx0E6	Hx0E7
OUT1 upper limit	unit: 0.1% range: OUT lower limit ~100%	Hx0E8	Hx0E9	Hx0EA	Hx0EB	Hx0EC	Hx0ED	Hx0EE	Hx0EF
OUT1 lower limit	unit: 0.1% range: 0 ~OUT upper limit %	Hx0F0	Hx0F1	Hx0F2	Hx0F3	Hx0F4	Hx0F5	Hx0F6	Hx0F7
OUT1 cycle time	unit: 0.1s range: 1 ~ 600 default:5s (RELAY: default 20s)	Hx0F8	Hx0F9	Hx0FA	Hx0FB	Hx0FC	Hx0FD	Hx0FE	Hx0FF
Sensor fail OUT1 power level	unit: 0.1 %	Hx100	Hx101	Hx102	Hx103	Hx104	Hx105	Hx106	Hx107
OUT2 control hysteresis	unit: 0.1(PV unit) range: 0 ~ 9,999	Hx118	Hx119	Hx11A	Hx11B	Hx11C	Hx11D	Hx11E	Hx11F
% OUT2 power (Manual)	range: 0.1 %	Hx120	Hx121	Hx122	Hx123	Hx124	Hx125	Hx126	Hx127
OUT2 upper limit	unit: 0.1% range: OUT lower limit ~100%	Hx128	Hx129	Hx12A	Hx12B	Hx12C	Hx12D	Hx12E	Hx12F
OUT2 lower limit	unit: 0.1% range: 0 ~OUT	Hx130	Hx131	Hx132	Hx133	Hx134	Hx135	Hx136	Hx137

Chapter 7:Appendix

Name	Description	CH1	CH2	CH3	CH4	CH5	CH6	CH7	CH8
	upper limit %								
OUT2 cycle time	unit: 0.1s range: 1 ~ 600 default: 5s (RELAY: default 20s)	Hx138	Hx139	Hx13A	Hx13B	Hx13C	Hx13D	Hx13E	Hx13F
Sensor fail OUT2 power level	unit: 0.1 %	Hx140	Hx141	Hx142	Hx143	Hx144	Hx145	Hx146	Hx147
Output power offset	unit: 0.1% range: 0 ~ 1,000	Hx170	Hx171	Hx172	Hx173	Hx174	Hx175	Hx176	Hx177
Deadband	-99.9 ~ 999.9	Hx178	Hx179	Hx17A	Hx17B	Hx17C	Hx17D	Hx17E	Hx17F
cooling way	0: as the same as heat 1: linear 2: air cooling 3: water cooling	Hx180	Hx181	Hx182	Hx183	Hx184	Hx185	Hx186	Hx187
OUT1 to station- channel*1	Bit7~4:station number Bit3~0:channel location	Hx190	Hx191	Hx192	Hx193	Hx194	Hx195	Hx196	Hx197
OUT2 to station- channel*1	Bit7~4: station number Bit3~0: channel location	Hx198	Hx199	Hx19A	Hx19B	Hx19C	Hx19D	Hx19E	Hx19F
ALM1 to station- channel*1	Bit7~4: station number Bit3~0: channel location	Hx1A0	Hx1A1	Hx1A2	Hx1A3	Hx1A4	Hx1A5	Hx1A6	Hx1A7
ALM2 to station- channel*1	Bit7~4: station number Bit3~0: channel location	Hx1A8	Hx1A9	Hx1AA	Hx1AB	Hx1AC	Hx1AD	Hx1AE	Hx1AF
ALM3 to station- channel*1	Bit7~4: station number Bit3~0: channel location	Hx1B0	Hx1B1	Hx1B2	Hx1B3	Hx1B4	Hx1B5	Hx1B6	Hx1B7
CT1 to station- channel*1	Bit7~4: station number Bit3~0: channel location	Hx1C0	Hx1C1	Hx1C2	Hx1C3	Hx1C4	Hx1C5	Hx1C6	Hx1C7
CT2 to station- channel*1	Bit7~4: station number Bit3~0: channel location	Hx1C8	Hx1C9	Hx1CA	Hx1CB	Hx1CC	Hx1CD	Hx1CE	Hx1CF
Control	0: Stop	Hx248	Hx249	Hx24A	Hx24B	Hx24C	Hx24D	Hx24E	Hx24F

Name	Description	CH1	CH2	CH3	CH4	CH5	CH6	CH7	CH8
status	1: Run 2: Program ends 3: Program pause								
Auto-tuning	0: Stop 1: In progress	Hx250	Hx251	Hx252	Hx253	Hx254	Hx255	Hx256	Hx257
PV value	unit: 0.1	Hx268	Hx269	Hx26A	Hx26B	Hx26C	Hx26D	Hx26E	Hx26F
SV value(R)	unit: 0.1	Hx270	Hx271	Hx272	Hx273	Hx274	Hx275	Hx276	Hx277
% OUT1 power (Automatic)	unit: 0.1 %	Hx278	Hx279	Hx27A	Hx27B	Hx27C	Hx27D	Hx27E	Hx27F
% OUT2 power (Automatic)	unit: 0.1 %	Hx280	Hx281	Hx282	Hx283	Hx284	Hx285	Hx286	Hx287
Channel status	enable=1; disable=0 Bit7: auto-tune Bit6: OUT1 Bit5: OUT2 Bit4: ALM1 Bit3: °F Bit2: °C Bit1: ALM2 Bit0: ALM3	Hx288	Hx289	Hx28A	Hx28B	Hx28C	Hx28D	Hx28E	Hx28F
CT1 value ^{*2}	unit: 0.1 A	Hx2C8	Hx2C9	Hx2CA	Hx2CB	Hx2CC	Hx2CD	Hx2CE	Hx2CF
CT2 value ^{*3}	unit: 0.1 A	Hx2D0	Hx2D1	Hx2D2	Hx2D3	Hx2D4	Hx2D5	Hx2D6	Hx2D7
Proportional band	unit: 0.1(°C or °F) range:0 ~ 9,999	Hx2E1	Hx2E9	Hx2F1	Hx2F9	Hx301	Hx309	Hx311	Hx319
Integral time	unit: s default: 0 ~ 9,999	Hx2E2	Hx2EA	Hx2F2	Hx2FA	Hx302	Hx30A	Hx312	Hx31A
Derivative time	unit: s default: 0 ~ 9,999	Hx2E3	Hx2EB	Hx2F3	Hx2FB	Hx303	Hx30B	Hx313	Hx31B
Cooling side proportional band	unit: 0.1(°C or °F) range:0 ~ 9,999	Hx2E4	Hx2EC	Hx2F4	Hx2FC	Hx304	Hx30C	Hx314	Hx31C
Cooling side integral time	unit: s default: 0 ~ 9,999	Hx2E5	Hx2ED	Hx2F5	Hx2FD	Hx305	Hx30D	Hx315	Hx31D
Cooling side derivative time	unit: s default: 0 ~ 9,999	Hx2E6	Hx2EE	Hx2F6	Hx2FE	Hx306	Hx30E	Hx316	Hx31E
PID Group	0~3: group1~4	Hx3E8	Hx3E9	Hx3EA	Hx3EB	Hx3EC	Hx3ED	Hx3EE	Hx3EF

Chapter 7:Appendix

Name	Description	CH1	CH2	CH3	CH4	CH5	CH6	CH7	CH8
	4: Automatic switch								
SV ramp rate	unit: 0.1°C/min range: 0 ~ 3,000	Hx3F0	Hx3F1	Hx3F2	Hx3F3	Hx3F4	Hx3F5	Hx3F6	Hx3F7
ALM1 max.	Record highest alarm value	Hx980	Hx981	H982	Hx983	Hx984	Hx985	Hx986	Hx987
ALM1 min.	Record lowest alarm value	Hx988	Hx989	Hx98A	Hx98B	Hx98C	Hx98D	Hx98E	Hx98F
ALM2 max.	Record highest alarm value	Hx990	Hx991	Hx992	Hx993	Hx994	Hx995	Hx996	Hx997
ALM2 min.	Record lowest alarm value	Hx998	Hx999	Hx99A	Hx99B	Hx99C	Hx99D	Hx99E	Hx99F
ALM3 max.	Record highest alarm value	Hx9A0	Hx9A1	Hx9A2	Hx9A3	Hx9A4	Hx9A5	Hx9A6	Hx9A7
ALM3 min.	Record lowest alarm value	Hx9A8	Hx9A9	Hx9AA	Hx9AB	Hx9AC	Hx9AD	Hx9AE	Hx9AF

Name	Address	CH1	CH2	CH3	CH4	CH5	CH6	CH7	CH8
Channel disable (0: disable, 1: enable)	Hx258	Bit0	Bit1	Bit2	Bit3	Bit4	Bit5	Bit6	Bit7
Temperature scale (0: °F 、 1: °C)	Hx259	Bit0	Bit1	Bit2	Bit3	Bit4	Bit5	Bit6	Bit7
Cold junction compensation select ^{*4}	Hx260	<p>Host: H0000:CH1 ~ CH8 are all used internal cold junction compensation (factory default). H0001: CH1 is the external cold junction temperature, and the remaining channels are all used the temperature value of CH1 as the external cold junction compensation. H0002: CH2 is the external cold junction temperature, and the remaining channels are all used the temperature value of CH2 as the external cold junction compensation. H0003: CH3 is the external cold junction temperature, and the remaining channels are all used the value of CH3 as the external cold junction compensation. H0004 = CH4 is the external cold junction temperature, and the remaining channels are all used the temperature value of CH4 as the external cold junction compensation. H0005 = CH5 is the external cold junction temperature, and the</p>							

	<p>remaining channels are all used the temperature of CH5 as the external cold junction compensation.</p> <p>H0006 = CH6 is the external cold junction temperature, and the remaining channels are all used the temperature value of CH6 as the external cold junction compensation.</p> <p>H0007 = CH7 is the external cold junction temperature, and the remaining channels are all used all compensated by using the temperature value of CH7 as the external cold junction.</p> <p>H0008 = CH8 is the external cold junction temperature, and the remaining channels are all used all based on the temperature value of CH8 as the external cold junction compensation.</p> <p><u>Measurement Expansion module:</u></p> <p>H0000: CH1 ~ CH8 are all used internal cold junction compensation. (factory default)</p> <p>H0009: CH1 ~ CH8 are all compensated by the external cold junction temperature transmitted from the DTM host.</p> <p>H0001: CH1 is the external cold junction temperature, and the remaining channels are all used the temperature value of CH1 as the external cold junction compensation.</p> <p>H0002: CH2 is the external cold junction temperature, and the remaining channels are all used the temperature value of CH2 as the external cold junction compensation.</p> <p>H0003: CH3 is the external cold junction temperature, and the remaining channels are all used the value of CH3 as the external cold junction compensation.</p> <p>H0004: CH4 is the external cold junction temperature, and the remaining channels are all used the temperature value of CH4 as the external cold junction compensation.</p> <p>H0005: CH5 is the external cold junction temperature, and the remaining channels are all used the temperature of CH5 as the external cold junction compensation.</p> <p>H0006: CH6 is the external cold junction temperature, and the remaining channels are all used the temperature value of CH6 as the external cold junction compensation.</p> <p>H0007: CH7 is the external cold junction temperature, and the remaining channels are all used compensated by using the temperature value of CH7 as the external cold junction.</p> <p>H0008: CH8 is the external cold junction temperature, and the remaining channels are all used the temperature value of CH8 as the external cold</p>
--	--

Chapter 7:Appendix

junction compensation.

❖ *Note:*

- 1) Write content H00yz according to DTM-DOx, DTM-CTx series accessory station number (y: 1 ~ F) and channel (z: 0 ~ 7), and so on. Example: If you want to assign "output 2 of input CH1" of the measurement expansion module with internal station number address 2 to the "CH1 terminal" of DTM-DOx series accessories of internal station number address 4, write the content "H0040" into address H2198
- 2) When using CT1, first CT1 corresponds to output 1, and output 1 must be assigned to use [expansion cassette], and output 1 corresponds to the same host or measurement expansion module, and the corresponding DTM-CT030 station number can choose 1 ~ F °
- 3) When using CT2, first CT2 corresponds to output 2. Output 2 can be designated to use [Expansion Cassette] or [I / O Expansion Module]. When [Expansion Cassette] is specified for output 2, output 2 must correspond to the same host or measurement expansion module, and the corresponding DTM-CT030 station number can be selected from 1 ~ F, or the same DTM-CT030 as CT1. ; When [IO Expansion Module] is specified for output 2, output 2 must correspond to the same IO expansion module, and the corresponding DTM-CT030 station number can only select 9 ~ F, and cannot be the same DTM-CT030 as CT1. Only a second DTM-CT030 can be installed, and the corresponding IO expansion module must be the same as the second DTM-CT030 station number °
- 4) Example: to use the CH1 temperature value of host as the external cold junction compensation of other channels, write the content [H0001] into the address [H0260]. The selection of CH1's input can be PT100 or thermocouple type. x indicates the internal station number of the host or measurement expansion module.

7.1.2 Operating Commands for Expansion Cassette Series

Output adjustment value settings for DTM-BDC or DTM-BDL expansion cassette (see Section 1.4 for device types) that can be calibrated.

Analog output current adjustment increment: 1μA/scale; Analog output voltage adjustment increment: 1mV/scale

Name	Description	CH1	CH2	CH3	CH4	CH5	CH6	CH7	CH8
AO lower limit adjust (expansion cassette)	4~20mA or 0~10V fine tune	Hx228	Hx229	Hx22A	Hx22B	Hx22C	Hx22D	Hx22E	Hx22F
AO upper limit adjust (expansion cassette)	4~20mA or 0~10V fine tune	Hx230	Hx231	Hx232	Hx233	Hx234	Hx235	Hx236	Hx237

❖ *Note:*

- 1) x is the station number of DTM-BDC and DTM-BDL, x = 0 represents the host.
- 2) The 8 physical output points of the DTM host and the measurement expansion module itself (equipped with two expansion cassettes) are preset for control output 1.
- 3) The output must be used with the input. When there is no signal at the input, the output will not work.

7.1.3 DTM-DOx Series Accessory Operating Commands

To ensure that DTM-DO series accessories can perform output actions, DTM-DOx series accessories can be set to DTM-DOx internal station numbers and channels corresponding to output 1 and 2 via the DTM host or measurement expansion module.

Output adjustment value settings for DTM-DOC, DTM-DOL IO expansion modules (see Section 1.4 for device types) that can be calibrated.

Analog output current adjustment increment: 1 μ A/scale; Analog output voltage adjustment increment: 1mV/scale

Name	Description	CH1	CH2	CH3	CH4	CH5	CH6	CH7	CH8
AO lower limit adjust (I/O expansion module)	4~20mA or 0~10V fine tune	Hx789	Hx78A	Hx78B	Hx78C	Hx7C9	Hx7CA	Hx7CB	Hx7CC
AO upper limit adjust (I/O expansion module)	4~20mA or 0~10V fine tune	Hx78D	Hx78E	Hx78F	Hx790	Hx7CD	Hx7CE	Hx7CF	Hx7D0

❖ *Note:*

1. *x is the internal station number of DTM-DOC, DTM-DOL*
2. *Outputs must have an accompanying input; when the input has no signal, the output will have no action.*

7.1.4 DTM-CT Series Accessory Operating Commands

DTM-CT series accessories are only used for current measurements; the address below can be used to read the CT sensors current value (units: 0.1A), the y at the bottom represents the DTM-CT station number. Please refer to **[Section 6.3]** for a detailed introduction.

Name	Description	CH1	CH2	CH3	CH4	CH5	CH6	CH7	CH8
CT current when OUT being ON or OFF	unit: 0.1A range: 0 ~ 9,999	Hy2C0	Hy2C1	Hy2C2	Hy2C3	Hy2C4	Hy2C5	Hy2C6	Hy2C7
Name	Address	CH1	CH2	CH3	CH4	CH5	CH6	CH7	CH8
CT sensor mode 0: 30A \ 1: 100A	Hy841	Bit0	Bit1	Bit2	Bit3	Bit4	Bit5	Bit6	Bit7

Notes: y is the internal station number of DTM-CT030.

Chapter 7:Appendix

7.1.5 Programmable Control Planning Table Parameter Settings

Name	Description	CH1	CH2	CH3	CH4	CH5	CH6	CH7	CH8
Step remaining time(sec)	Unit: sec	Hx2B0	Hx2B1	Hx2B2	Hx2B3	Hx2B4	Hx2B5	Hx2B6	Hx2B7
Step remaining time(min)	Unit: min	Hx2B8	Hx2B9	Hx2BA	Hx2BB	Hx2BC	Hx2BD	Hx2BE	Hx2BF
Pattern status	0 ~ 7	Hx290	Hx291	Hx292	Hx293	Hx294	Hx295	Hx296	Hx297
Step status	0 ~ 7	Hx298	Hx299	Hx29A	Hx29B	Hx29C	Hx29D	Hx29E	Hx29F
Wait SV		Hx400	Hx401	Hx402	Hx403	Hx404	Hx405	H406	Hx407
Number of remaining rounds (R)		Hx2A0	Hx2A1	Hx2A2	Hx2A3	Hx2A4	Hx2A5	Hx2A6	Hx2A7
Current status of program (R)		Hx2A8	Hx2A9	Hx2AA	Hx2AB	Hx2AC	Hx2AD	Hx2AE	Hx2AF
Wait time		Hx408	Hx409	Hx40A	Hx40B	Hx40C	Hx40D	H40E	Hx40F
Start slope		Hx410	Hx411	Hx412	Hx413	Hx414	Hx415	H416	Hx417
Start pattern	0 ~ 7	Hx418	Hx419	Hx41A	Hx41B	Hx41C	Hx41D	Hx41E	Hx41F
Start step	0 ~ 7	Hx420	Hx421	Hx422	Hx423	Hx424	Hx425	Hx426	Hx427

Name	Description	Pattern 0	Pattern 1	Pattern 2	Pattern 3	Pattern 4	Pattern 5	Pattern 6	Pattern 7
End step	0 ~ 7 = N , indicates that this pattern is executed from step 0 to step N	Hx428	Hx429	Hx42A	Hx42B	Hx42C	Hx42D	Hx42E	Hx42F
Cycle count	0 ~ 199, indicates that this pattern is executed 1~200 times	Hx430	Hx431	Hx432	Hx433	Hx434	Hx435	Hx436	Hx437
Linked pattern	0 ~ 8, 8 indicates the end of the program, 0 ~ 7 indicates the next pattern number to be executed after this pattern ends.	Hx438	Hx439	Hx43A	Hx43B	Hx43C	Hx43D	Hx43E	Hx43F

Name	Description	Pattern0	Pattern 1	Pattern 2	Pattern 3	Pattern 4	Pattern 5	Pattern 6	Pattern 7
Step0 setting	Step0 SV	Hx440	Hx442	Hx444	Hx446	Hx448	Hx44A	Hx44C	Hx44E
	Step0 time	Hx441	Hx443	Hx445	Hx447	Hx449	Hx44B	Hx44D	Hx44F
Step1 setting	Step1 SV	Hx450	Hx452	Hx454	Hx456	Hx458	Hx45A	Hx45C	Hx45E
	Step1 time	Hx451	Hx453	Hx455	Hx457	Hx459	Hx45B	Hx45D	Hx45F
Step2 setting	Step2 SV	Hx460	Hx462	Hx464	Hx466	Hx468	Hx46A	Hx46C	Hx46E
	Step2 time	Hx461	Hx463	Hx465	Hx467	Hx469	Hx46B	Hx46D	Hx46F
Step3 setting	Step3 SV	Hx470	Hx472	Hx474	Hx476	Hx478	Hx47A	Hx47C	Hx47E
	Step3 time	Hx471	Hx473	Hx475	Hx477	Hx479	Hx47B	Hx47D	Hx47F
Step4 setting	Step4 SV	Hx480	Hx482	Hx484	Hx486	Hx488	Hx48A	Hx48C	Hx48E
	Step4 time	Hx481	Hx483	Hx485	Hx487	Hx489	Hx48B	Hx48D	Hx48F
Step5 setting	Step5 SV	Hx490	Hx492	Hx494	Hx496	Hx498	Hx49A	Hx49C	Hx49E
	Step5 time	Hx491	Hx493	Hx495	Hx497	Hx499	Hx49B	Hx49D	Hx49F
Step6 setting	Step6 SV	Hx4A0	Hx4A2	Hx4A4	Hx4A6	Hx4A8	Hx4AA	Hx4AC	Hx4AE
	Step6 time	Hx4A1	Hx4A3	Hx4A5	Hx4A7	Hx4A9	Hx4AB	Hx4AD	Hx4AF
Step7 setting	Step7 SV	Hx4B0	Hx4B2	Hx4B4	Hx4B6	Hx4B8	Hx4BA	Hx4BC	Hx4BE
	Step7 time	Hx4B1	Hx4B3	Hx4B5	Hx4B7	Hx4B9	Hx4BB	Hx4BD	Hx4BF

7.1.6 PID Group Parameter Settings

Name	Description	CH1	CH2	CH3	CH4	CH5	CH6	CH7	CH8
PID Group1 SV	unit: 0.1	Hx500	Hx508	Hx510	Hx518	Hx520	Hx528	Hx530	Hx538
PID Group1 proportional band	unit: 0.1 range: 0 ~ 9,999	Hx501	Hx509	Hx511	Hx519	Hx521	Hx529	Hx531	Hx539
PID Group1 integral time	range: 0 ~ 9,999	Hx502	Hx50A	Hx512	Hx51A	Hx522	Hx52A	Hx532	Hx53A
PID Group1 derivative time	range: 0 ~ 9,999	Hx503	Hx50B	Hx513	Hx51B	Hx523	Hx52B	Hx533	Hx53B
PID Group1 cooling proportional band	unit: 0.1 range: 0 ~ 9,999	Hx504	Hx50C	Hx514	Hx51C	Hx524	Hx52C	Hx534	Hx53C
PID Group1 cooling integral time	range: 0 ~ 9,999	Hx505	Hx50D	Hx515	Hx51D	Hx525	Hx52D	Hx535	Hx53D
PID Group1	range: 0 ~ 9,999	Hx506	Hx50E	Hx516	Hx51E	Hx526	Hx52E	Hx536	Hx53E

Chapter 7:Appendix

Name	Description	CH1	CH2	CH3	CH4	CH5	CH6	CH7	CH8
cooling derivative time									
Reservation 1		Hx507	Hx50F	Hx517	Hx51F	Hx527	Hx52F	Hx537	Hx53F
PID Group2 SV	unit: 0.1	Hx540	Hx548	Hx550	Hx558	Hx560	Hx568	Hx570	Hx578
PID Group2 proportional band	unit: 0.1 range: 0 ~ 9,999	Hx541	Hx549	Hx551	Hx559	Hx561	Hx569	Hx571	Hx579
PID Group2 integral time	range: 0 ~ 9,999	Hx542	Hx54A	Hx552	Hx55A	Hx562	Hx56A	Hx572	Hx57A
PID Group2 derivative time	range: 0 ~ 9,999	Hx543	Hx54B	Hx553	Hx55B	Hx563	Hx56B	Hx573	Hx57B
PID Group2 cooling proportional band	unit: 0.1 range: 0 ~ 9,999	Hx544	Hx54C	Hx554	Hx55C	Hx564	Hx56C	Hx574	Hx57C
PID Group2 cooling integral time	range: 0 ~ 9,999	Hx545	Hx54D	Hx555	Hx55D	Hx565	Hx56D	Hx575	Hx57D
PID Group2 cooling derivative time	range: 0 ~ 9,999	Hx546	Hx54E	Hx556	Hx55E	Hx566	Hx56E	Hx576	Hx57E
Reservation 2		Hx547	Hx54F	Hx557	Hx55F	Hx567	Hx56F	Hx577	Hx57F
PID Group3 SV	unit: 0.1	Hx580	Hx588	Hx590	Hx598	Hx5A0	Hx5A8	Hx5B0	Hx5B8
PID Group3 proportional band	unit: 0.1 range: 0 ~ 9,999	Hx581	Hx589	Hx591	Hx599	Hx5A1	Hx5A9	Hx5B1	Hx5B9
PID Group3 integral time	range: 0 ~ 9,999	Hx582	Hx58A	Hx592	Hx59A	Hx5A2	Hx5AA	Hx5B2	Hx5BA
PID Group3 derivative time	range: 0 ~ 9,999	Hx583	Hx58B	Hx593	Hx59B	Hx5A3	Hx5AB	Hx5B3	Hx5BB
PID Group3 cooling proportional band	unit: 0.1 range: 0 ~ 9,999	Hx584	Hx58C	Hx594	Hx59C	Hx5A4	Hx5AC	Hx5B4	Hx5BC
PID Group3 cooling integral time	range: 0 ~ 9,999	Hx585	Hx58D	Hx595	Hx59D	Hx5A5	Hx5AD	Hx5B5	Hx5BD
PID Group3	range: 0 ~ 9,999	Hx586	Hx58E	Hx596	Hx59E	Hx5A6	Hx5AE	Hx5B6	Hx5BE

Name	Description	CH1	CH2	CH3	CH4	CH5	CH6	CH7	CH8
cooling derivative time									
Reservation 3		Hx587	Hx58F	Hx597	Hx59F	Hx5A7	Hx5AF	Hx5B7	Hx5BF
PID Group4 SV	unit: 0.1	Hx5C0	Hx5C8	Hx5D0	Hx5D8	Hx5E0	Hx5E8	Hx5F0	Hx5F8
PID Group4 proportional band	unit: 0.1 range: 0 ~ 9,999	Hx5C1	Hx5C9	Hx5D1	Hx5D9	Hx5E1	Hx5E9	Hx5F1	Hx5F9
PID Group4 integral time	range: 0 ~ 9,999	Hx5C2	Hx5CA	Hx5D2	Hx5DA	Hx5E2	Hx5EA	Hx5F2	Hx5FA
PID Group4 derivative time	range: 0 ~ 9,999	Hx5C3	Hx5CB	Hx5D3	Hx5DB	Hx5E3	Hx5EB	Hx5F3	Hx5FB
PID Group4 cooling proportional band	unit: 0.1 range: 0 ~ 9,999	Hx5C4	Hx5CC	Hx5D4	Hx5DC	Hx5E4	Hx5EC	Hx5F4	Hx5FC
PID Group4 cooling integral time	range: 0 ~ 9,999	Hx5C5	Hx5CD	Hx5D5	Hx5DD	Hx5E5	Hx5ED	Hx5F5	Hx5FD
PID Group4 cooling derivative time	range: 0 ~ 9,999	Hx5C6	Hx5CE	Hx5D6	Hx5DE	Hx5E6	Hx5EE	Hx5F6	Hx5FE

7.1.7 Modbus Communications Function Code

ASCII mode:

Communications transmission format: H03 = byte read; H06 = byte write

Read command		Read reply string		Write command		Write reply string	
Initial word	':'	Initial word	':'	Initial word	':'	Initial word	':'
Machine address 1	'0'	Machine address 1	'0'	Machine address 1	'0'	Machine address 1	'0'
Machine address 0	'1'	Machine address 0	'1'	Machine address 0	'1'	Machine address 0	'1'
Function command 1	'0'	Function command 1	'0'	Function command 1	'0'	Function command 1	'0'
Function command 0	'3'	Function command 0	'3'	Function command 0	'6'	Function command 0	'6'
Read data /bit	'4'	Reply data length	'0'	Data address	'1'	Data address	'1'

Chapter 7:Appendix

Read command		Read reply string		Write command		Write reply string	
initial address	'1'	(bytes)	'4'		'0'		'0'
	'F'	Address H1000	'0'		'0'		'0'
	'F'		'1'		'1'		'1'
Read data length (word)	'0'	Data content	'F'	Write data content	'0'	Write data content	'0'
	'0'		'4'		'3'		'3'
	'2'		'0'		'E'		'E'
LRC1 check code	'B'	Address H1001 Data content	'0'	LRC1 check code	'F'	LRC1 check code	'F'
			'0'	LRC0 check code	'D'	LRC0 check code	'D'
LRC0 check code	'A'						
Stop word 1	CR	LRC1 check code	'0'	Stop word 1	CR	Stop word 1	CR
Stop word 0	LF	LRC0 check code	'3'	Stop word 0	LF	Stop word 0	LF
		Stop word 1	CR				
		Stop word 0	LF				

LRC check code:

ASCII uses LRC for error checking; this method adds the bytes in all transmitted data, discarding the smallest bit, and then taking the complement of 2; LRC check code consists of the "machine address" added to the "data content."

❖ *Example: Assuming the data in a packet consists of [H01, H03, H41, HFF, H00, H02], the sum of the packets data content is taken as follows:*

H01+H03+H41+HFF+H00+H02=H146, and discarding the smallest bit 1, leaving H46

Taking the complement of 2 from [H46] leaves [HBA] which is the LRC check code.

RTU mode:

Read command		Read reply string		Write command		Write reply string	
Machine address	H01	Machine address	H01	Machine address	H01	Machine address	H01
Function command	H03	Function command	H03	Function command	H06	Function command	H06
Read data initial address	H10	Reply data length (bytes)	H04	Write data address	H10	Write data address	H10
	H00				H01		H01
Read data	H00	Data content 1	H01	Write data	H03	Write data	H03

length (character/ word)	H02		HF4	content	H20	content	H20
CRC least bit	HC0		H03	CRC least bit	HDD	CRC least bit	HDD
CRC highest bit	HCB	Data content 2	H20	CRC highest bit	HE2	CRC highest bit	HE2
		CRC least bit	HBB				
		CRC highest bit	H15				

CRC check code:

RTU uses CRC to perform error checking. The following is an explanation of calculation steps and example program:

Step 1: Enter the 16-bit register of content consisting of FFFFH, and term it the "CRC" register.

Step 2: Perform the Exclusive OR operation on the first byte of the command information and the least byte of the 16-bit CRC register, and return results to the CRC register.

Step 3: Examined the least significant bit (LSB) in the CRC register; if this bit is 0, move to the bit to its right; If this bit is 1, after the CRC register value is moved to the right one bit, perform Exclusive OR operation on A001H.

Step 4: Return to step 3, and perform step 3 8 times before proceeding to step 5.

Step 5: Repeat steps 2-4 on the next byte in the command information, until all bytes have been completely processed. At this time, the content of the CRC register will be the error detection value.

Example **CRC** program:

```

        unsigned int reg_crc = 0xffff;

i = 0;
while (length--)
{ reg_crc ^= RTUData[i];
  i ++;
  for (j = 0; j < 8; j++)
  { if (reg_crc & 0x01) reg_crc = (reg_crc >> 1) ^ 0xA001;
    else reg_crc = reg_crc >> 1;
  }
}
return(reg_crc);

```

7.2 Installation Method

7.2.1 Host

Host installation

- 1) Attach with DIN Rail fastener
- 2) Hang the DIN Rail fastener at the top of the controller diagonally on the DIN Rail
- 3) Press down on the DIN Rail fastener at the bottom of the controller to lock it
- 4) Confirm that the DIN Rail fastener is correctly fastened

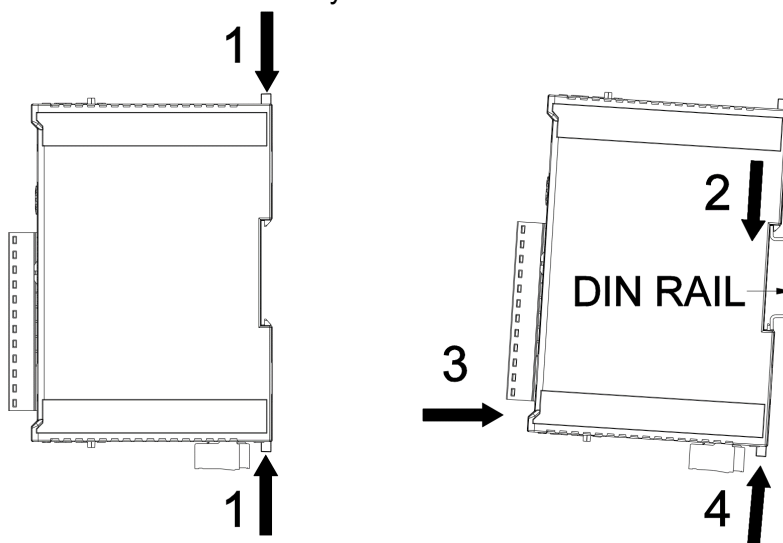

Removal from Host

- 1) Use a flat screwdriver or other tools to insert into the DIN Rail fasteners square hole. Apply pressure in the direction of the arrow when pulling the DIN Rail fastener out from beneath the controller
- 2) Lift up the controller and remove

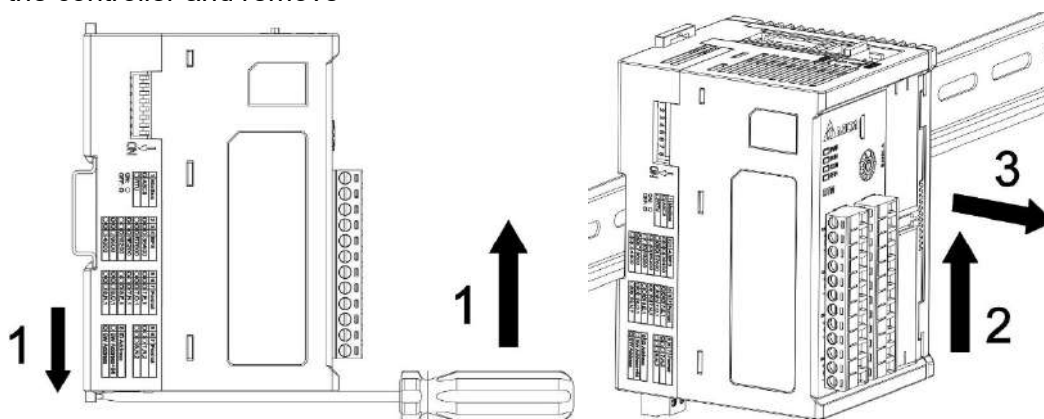

7.2.2 Expansion Cassette

- ❖ *Note: When adding/replacing an expansion cassette, make sure power has been shut off to the Host, and power up the Host after installation. The products in this series do not support hot swapping; please perform installation only after power has been turned off.*

Removal of protective cover

- 1) Use a flat screwdriver in the gap shown in steps 1-2, and maintain the angle shown in step 3
- 2) In step 4, insert straight in the direction and angle shown by the arrow, allowing the protective cover to be pushed away
- 3) In step 5, insert a flat screwdriver in the gap in the protective cover, which has already been pushed off, and lightly pry in the direction of the arrow in step 6, allowing the protective cover to be removed

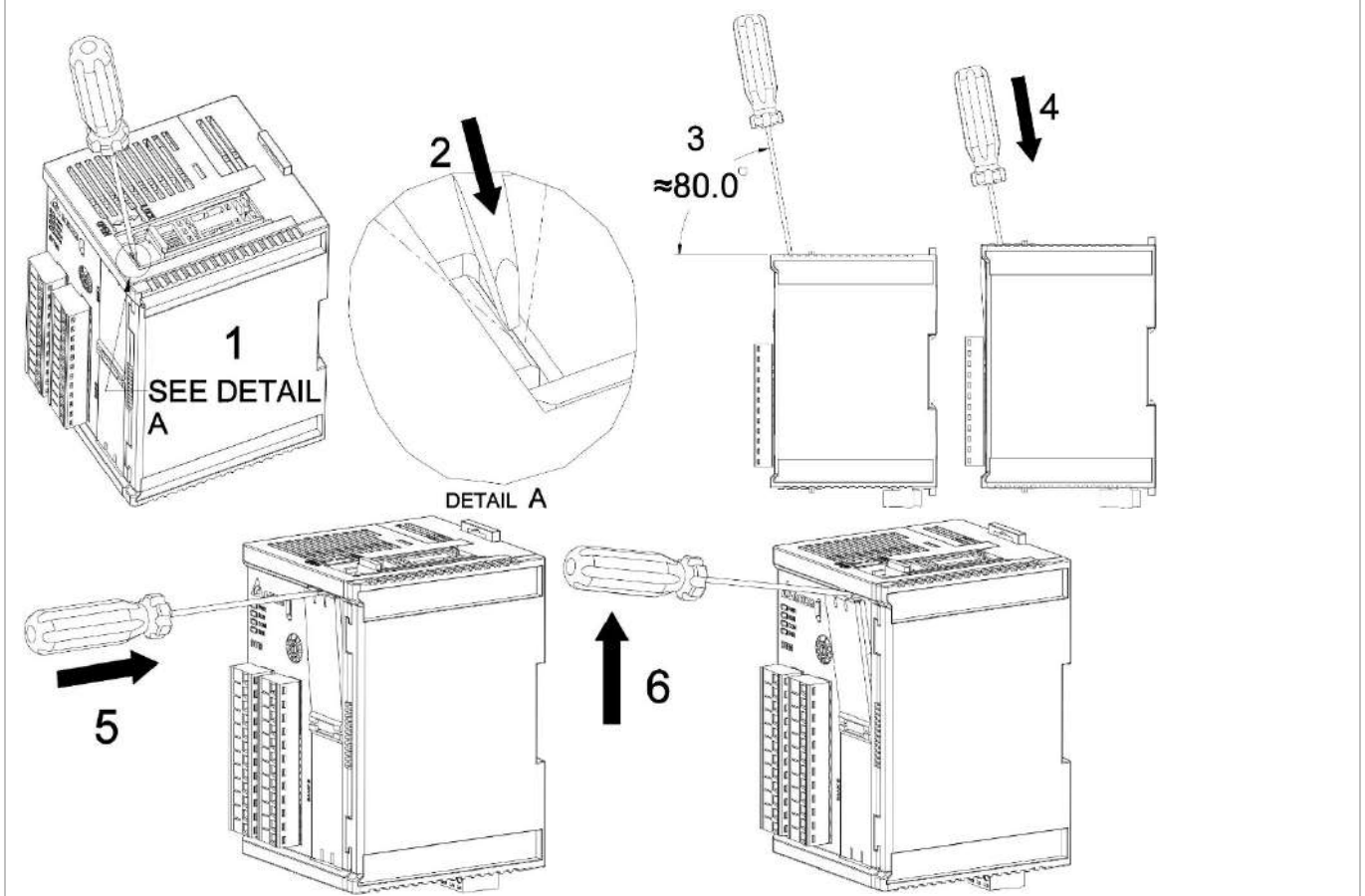

Installing a cassette

- 1) Push the cassette fastener until it is facing the **OPEN** location
- 2) Insert the cassette in the direction shown in the diagram, and push until it is in the lowest position
- 3) Push the cassette fastener until it is facing the **LOCK** position, which completes cassette attachment

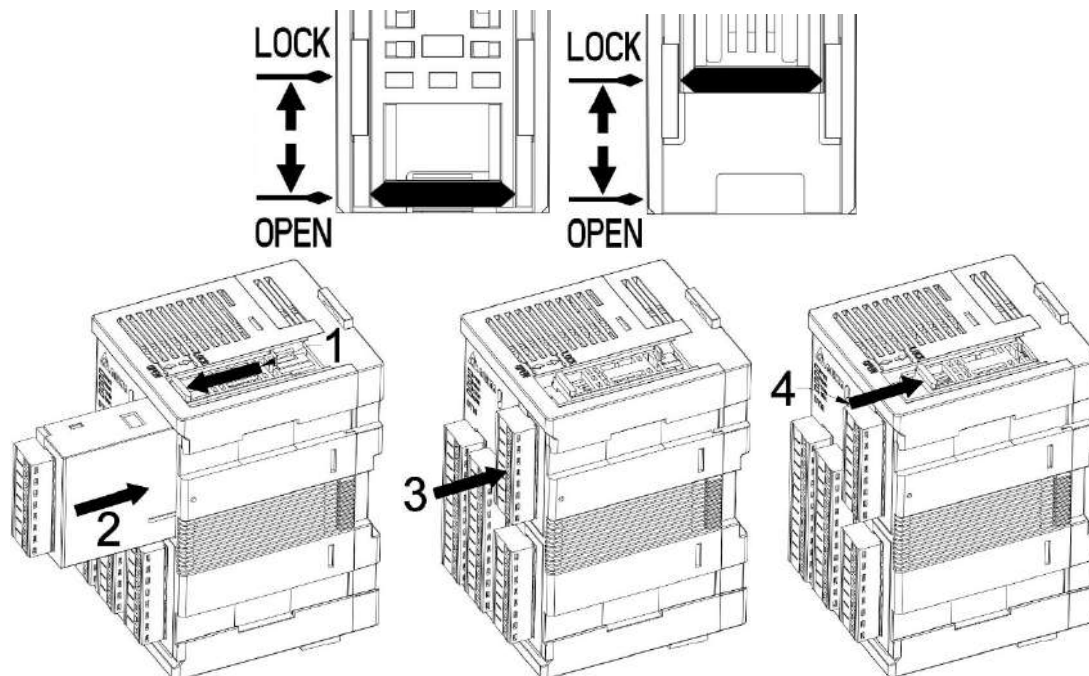

Removing a cassette

- 1) Push the cassette fastener until it is facing the **OPEN** location, and remove the cassette

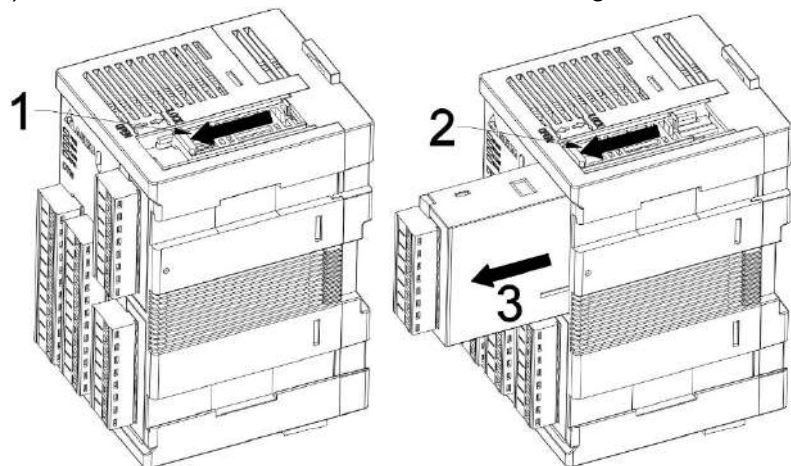

7.2.3 Measurement Expansion Module, I/O Expansion Module

❖ Notes:

1. If a measurement expansion module and I/O expansion module must be used at the same time, complete installation of the measurement expansion module before installing the I/O expansion module
2. When installing expansion modules, make sure to fit them on the expansion channel guides in order to ensure correct installation
3. When adding/replacing a measurement expansion module or I/O expansion module, make sure power has been shut off to the Host, and power up the Host after installation. The products in this series do not support hot swapping; please perform installation only after power has been turned off

Installation of expansion modules on DIN Rail

- 1) Host installation: Please refer to steps 1-4 of the previous Host installation procedures
- 2) Fastened the DIN Rail fasteners of all expansion modules
- 3) Remove the side protective covers: Remove in the direction shown in step 5
- 4) Installing a measurement expansion module: In step 6, insert the measurement expansion module and confirm that the upper and lower DIN Rail fasteners have been fastened. Insert from left to right in accordance with the number of needed modules
- 5) Installing an I/O expansion module: In step 7, after completing installation of the measurement expansion modules, insert the I/O expansion module(s) and confirm that the upper and lower DIN Rail fasteners have been fastened. insert from left to right in accordance with the number of needed modules
- 6) In step 8, install the side protective covers on the expansion terminal module

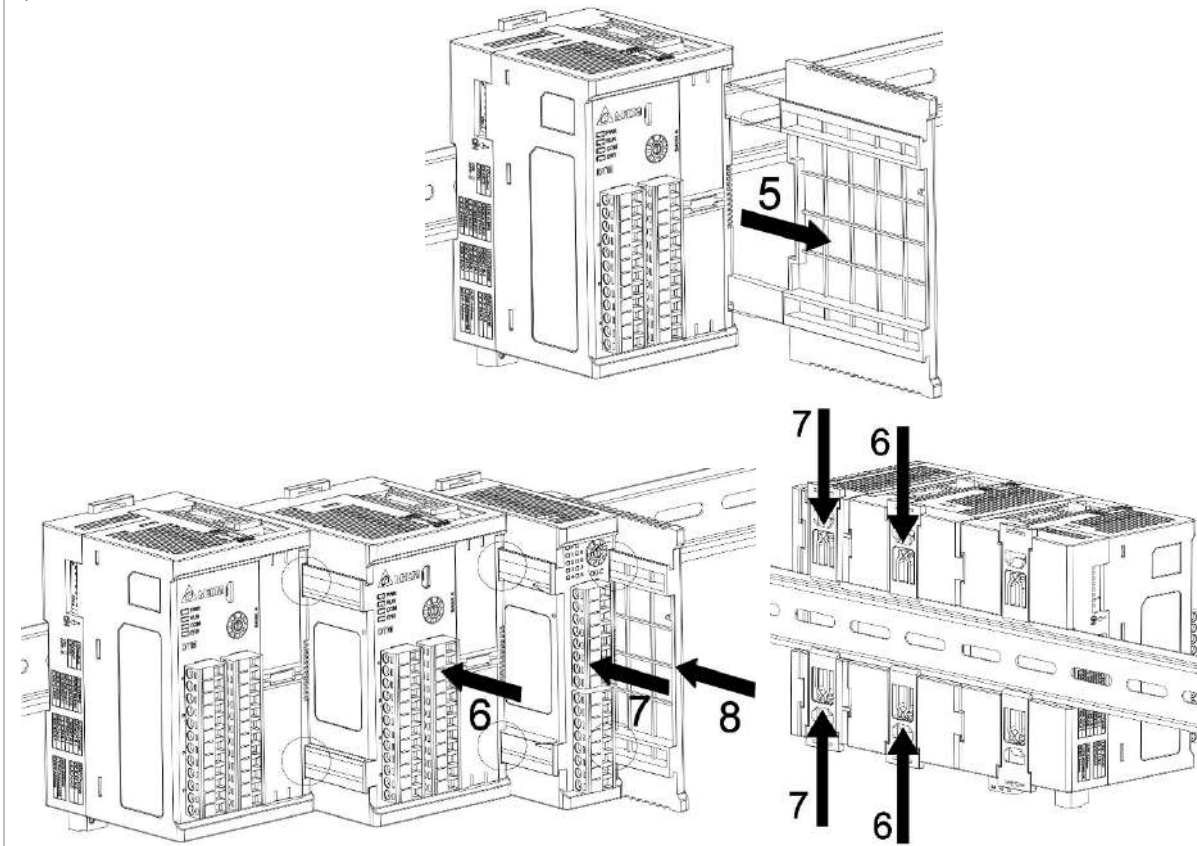

Replacing a module

- 1) Use a flat screwdriver or other tools to open the DIN Rail fasteners
- 2) Replace the modules in the direction shown in the diagram. Make sure to fit them on the expansion channel guides in order to ensure correct replacement

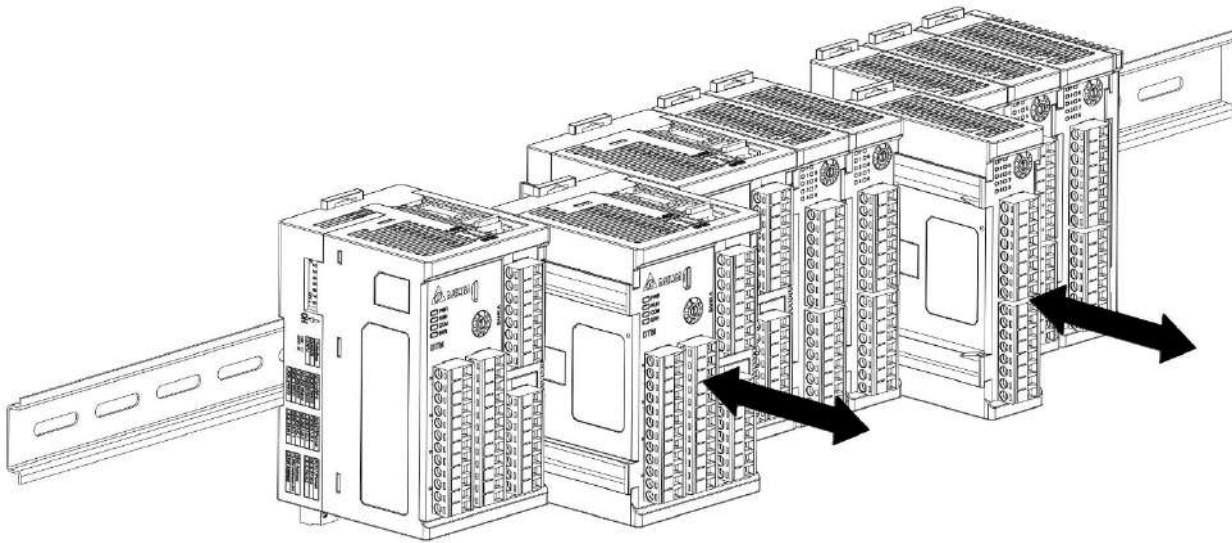

Ethernet and Internet connection:

- ❖ Notes: Connect CAT-5e network cable to the DTME08 or DTME04 RJ-45 port, as shown in the figure on the right.

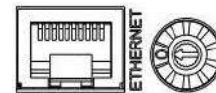

shown in the

7.2.4 Installation Guidelines

1. Open space should be left on all sides when installing a temperature controller; this will ensure that the temperature controller can radiate heat normally and will facilitate installation and removal of accessories.
 - **There should be 100mm of clearance on the upper, lower, right, and left sides of the equipment.**
2. Screws should be tightened to a torque of 3.80kg-cm (3.30 lb-in).
3. In order to avoid signal interference, power cords, load cords, and measurement signal cords should be run in different cable troughs.
4. The temperature controllers input power source should be a 12AWG - 24AWG single-core bare cable or multiple-core cable with 300V voltage resistance and resistance to 60/75°C.
5. The devices outer shell has warning markings indicating the input power supply location. If the input power is connected to another foot, this may cause the controller to burn out, and may injure persons nearby or start a fire.
6. If load requirements are too large when using a relay output device, this may cause the cables and crimp type terminals to become hot. When their temperature exceeds 50°C, please take care to avoid risk of burns.
7. Use needle-type crimp terminals less than 2.35mm in size.



7.2.5 Terminal Configuration Diagram

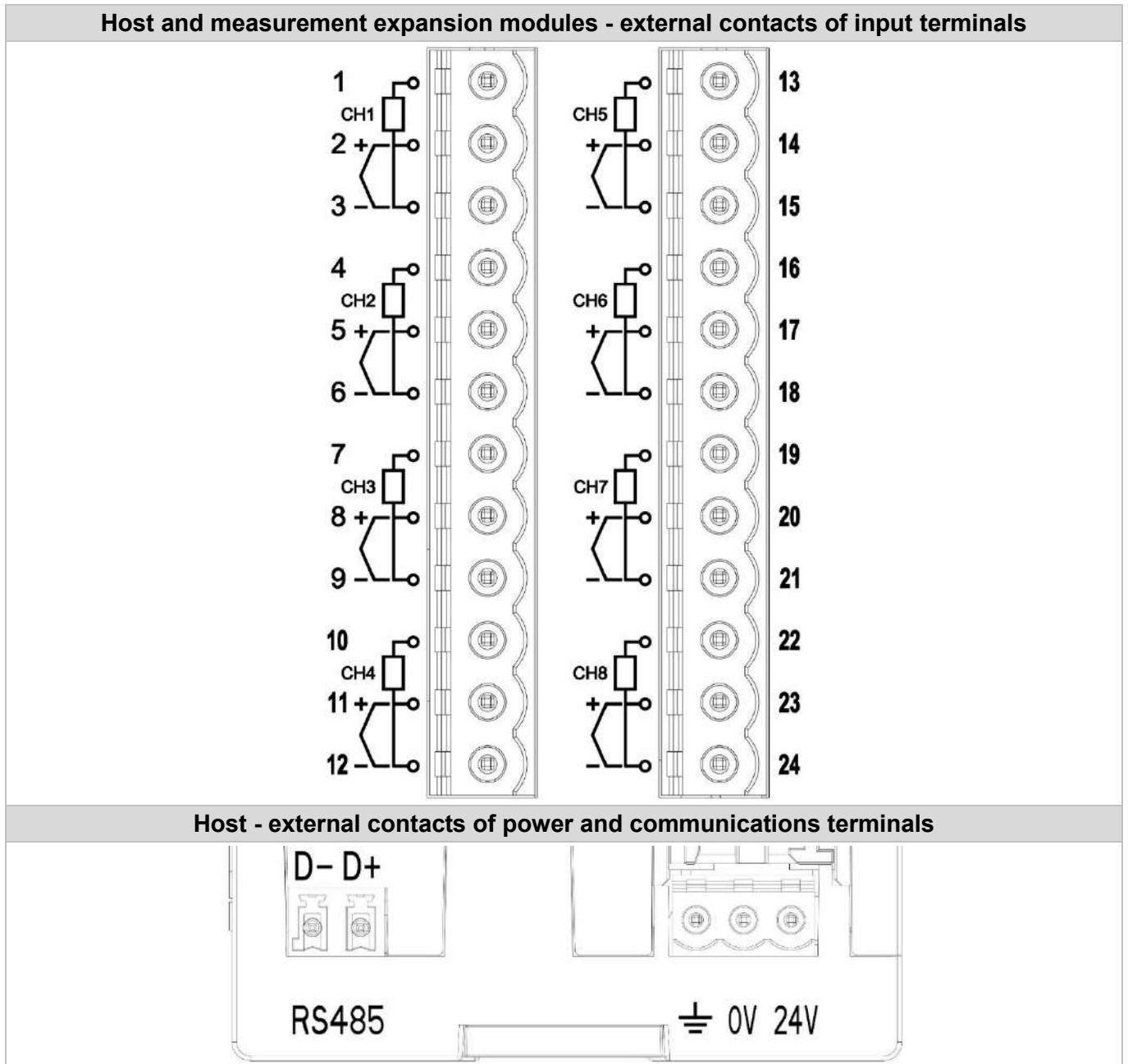

Chapter 7:Appendix

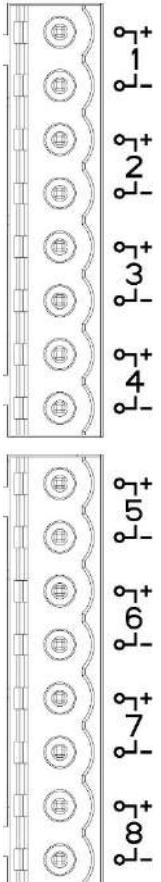
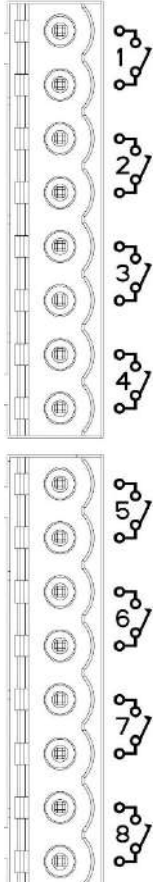
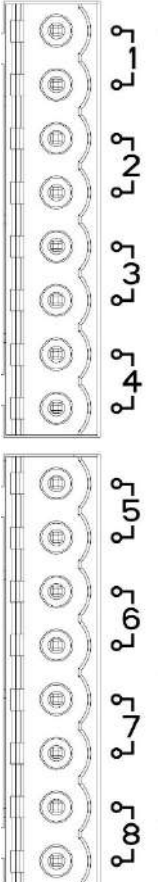
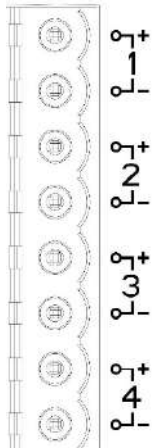
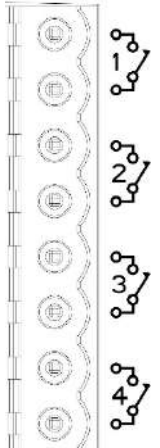
I/O expansion modules: Linear current, linear voltage, pulse voltage	I/O expansion modules: Relay	I/O expansion modules: CT
		
Expansion cassettes: Linear current, linear voltage, pulse voltage	Expansion cassettes: Relay	
		

7.3 Ethernet/ IP Software Setting

This chapter describes how to set up DTME series models through Delta communication software **DCISoft**, and explains the fields on each setting page. Before opening the setting page, **DCISoft** must first select Ethernet in the communication settings. After the setting is complete, you can open the DTME series model setting page through broadcast search and specified IP search. The setting function of DTME series models is to use UDP port 20006. Please pay attention to the relevant settings of the firewall. The following details explain how to open the settings page and the functions of each field.

Set the connection method as shown in the figure below. The computer can be connected to the DTME series models via a HUB connection or directly using a network cable.

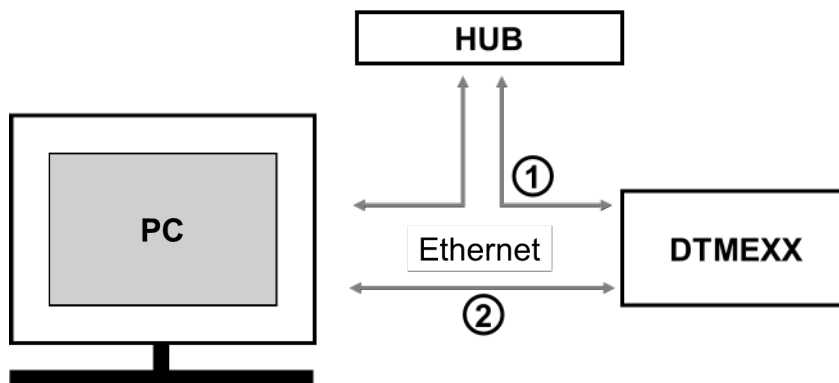

7.3.1 Setting up Communication and Searching for Modules in DCISoft

■ Communication Setting

1. Open **DCISoft** on the PC and select “**Tools**” => “**Communication Setting**”.

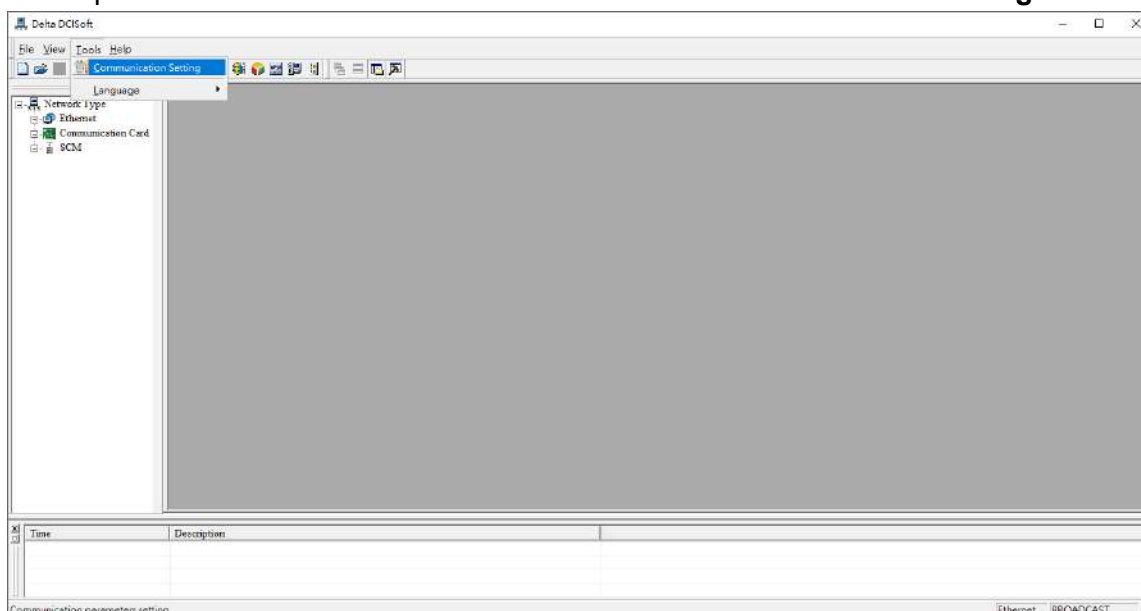

Chapter 7:Appendix

2. Select “Ethernet” for the communication setting.

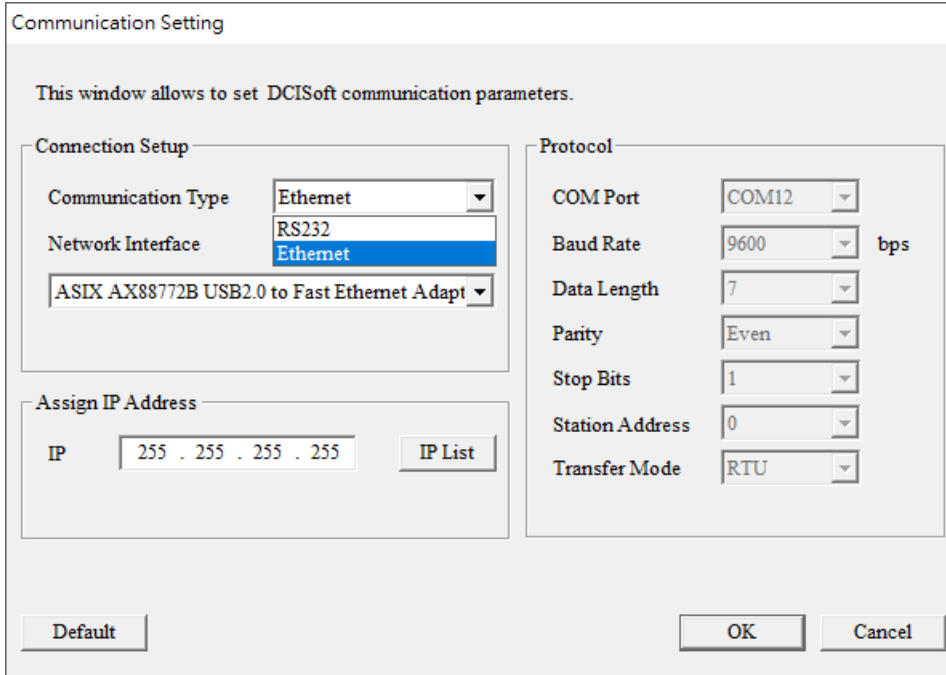

■ Search

1. Click the “Search” icon  in **DCISoft** to search for all Delta’s Ethernet products on the network by search function. The modules found are displayed in the left-hand side column, and the device list of all modules is displayed on the right-hand side column.

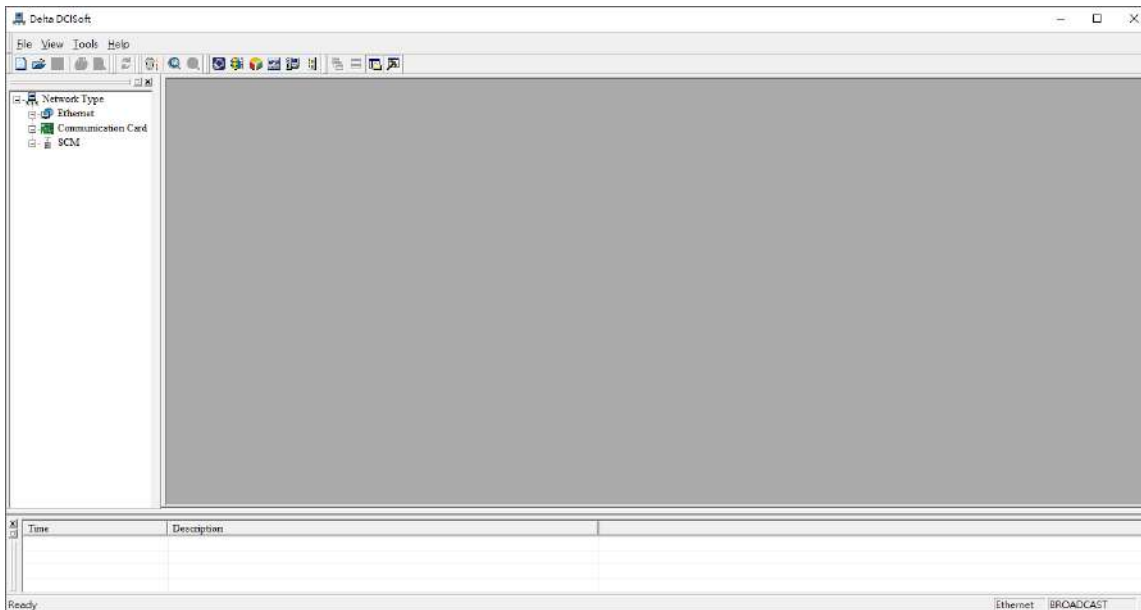

- Click the module you need in the left-hand side column to display the device list of the module in the right-hand side column. Double click the device on the right-hand side column to enter the setup page of the device.

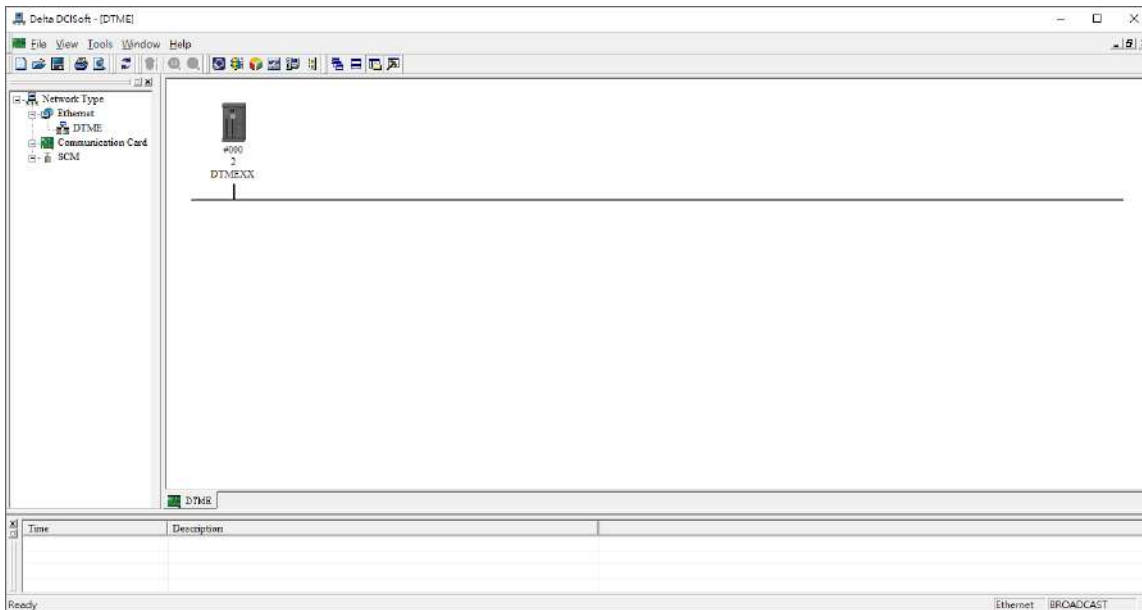

- The setup page for **DTMEXX**

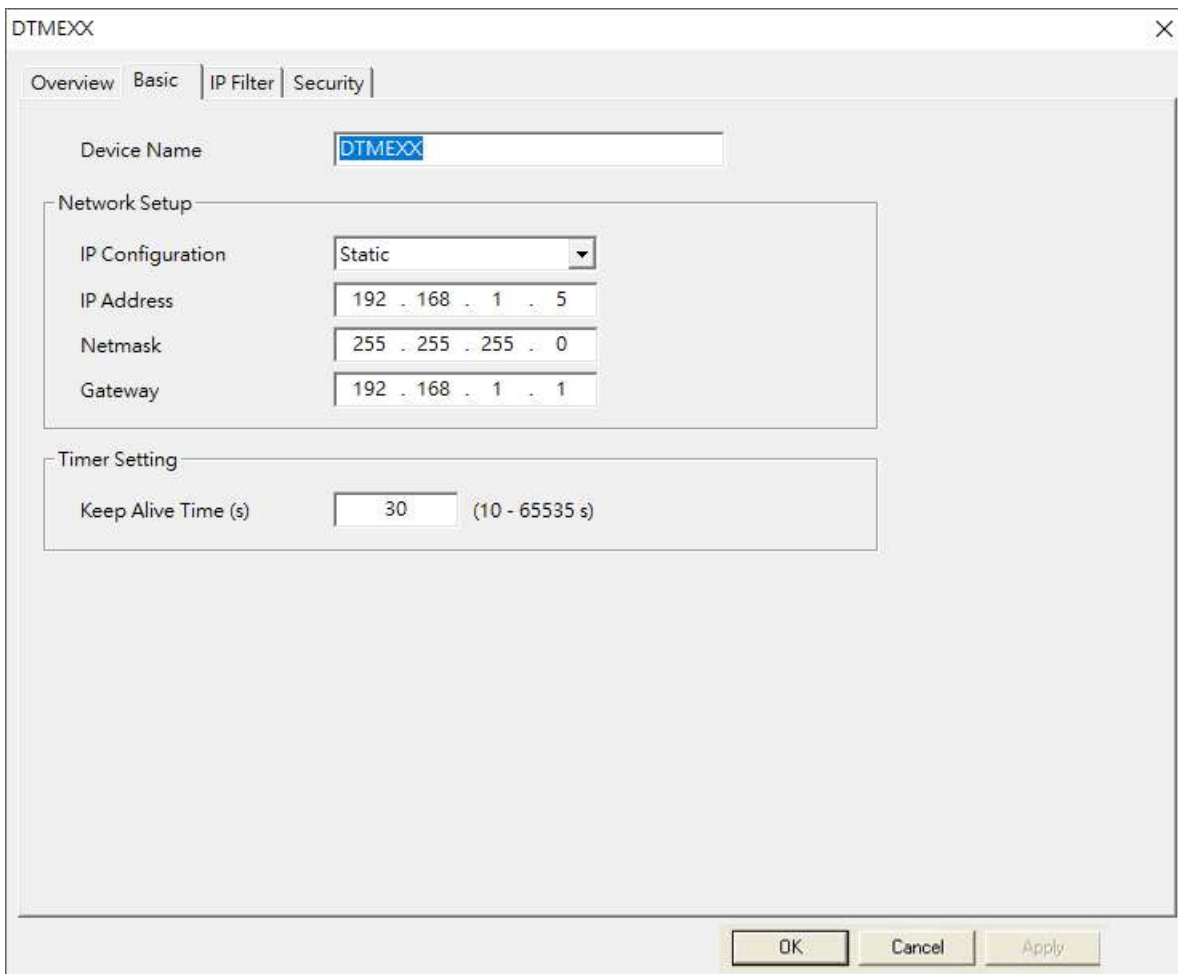

Chapter 7:Appendix

■ Search for Designated Module

1. Click “**Communication Card**” in the left-hand side column. Right click the mouse and select “**Configure**” to search for the designated module.

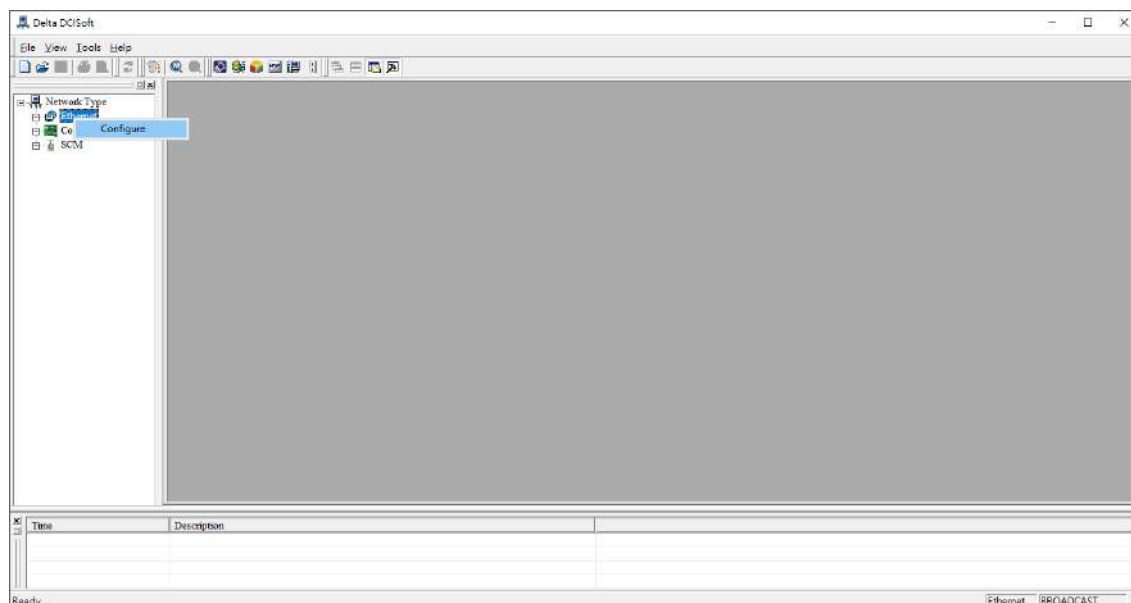

2. Select **DTME** to be searched. Click “**OK**” and DCISoft will start to search for the existing DTME cards on the network.

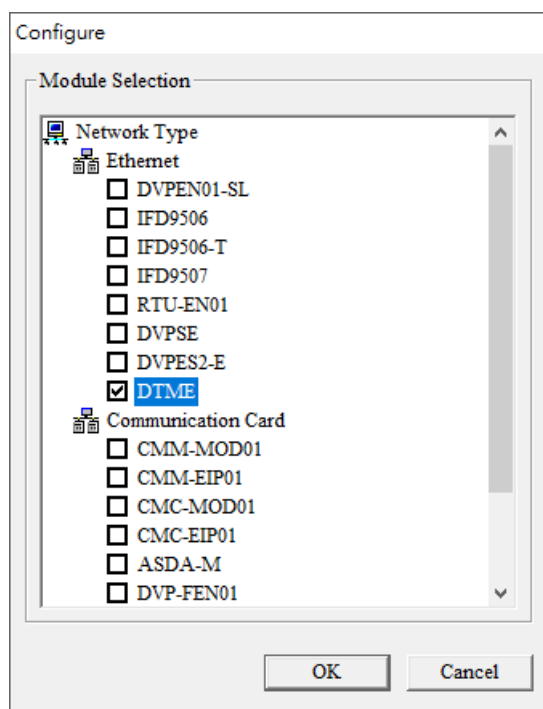

3. Device list of the existing DTME

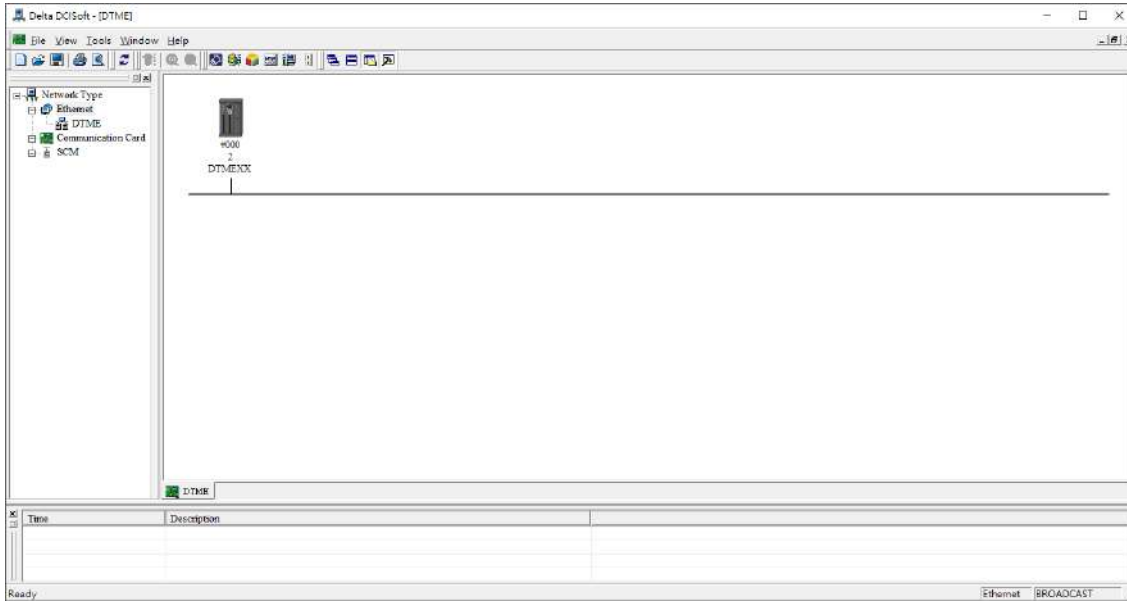

■ Search for Designated IP

1. If the device and PC are not on the same local area network, or the communication card cannot be found by broadcasting, please use the specified IP method to search. Set the communication type to **“Ethernet”** and enter the designated IP address in the address column. Click **“OK”**.

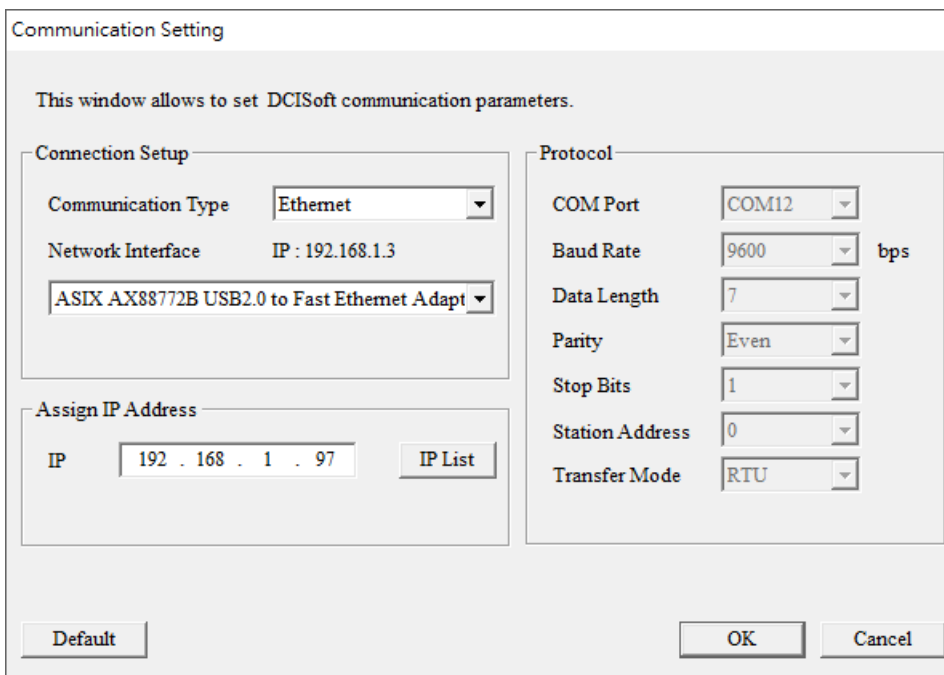

Chapter 7:Appendix

2. Click “IP Search” icon  to start searching for the designated IP.

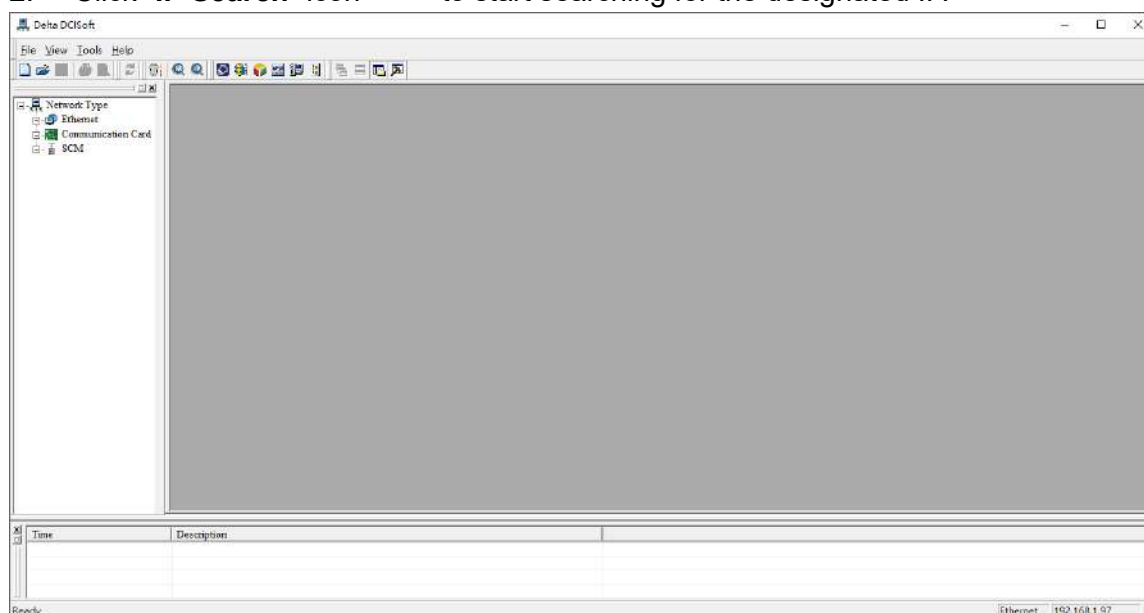

3. The **DTMEXX** found is displayed in the right-hand side column. Double click the device to be set up to enter its setup page.

7.3.2 Basic Settings

The basic settings include the settings for device name, network and timer.

■ The basic

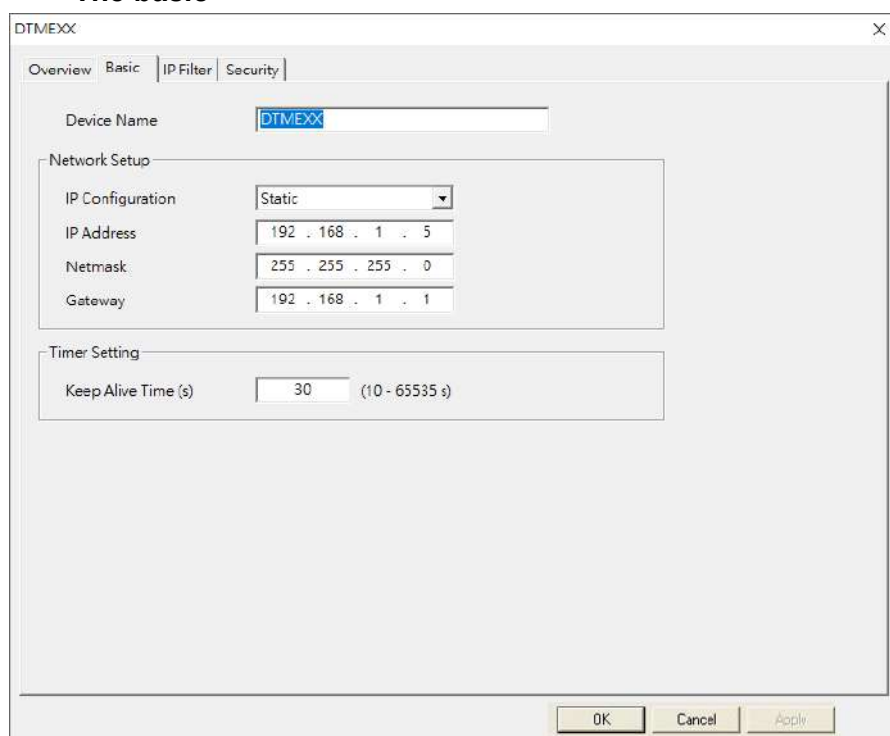

1. Device name

There can be many **DTMEXX** cards on the network. Therefore, you can set up a device name for the module to be controlled to identify it when you need to search for it.

2. Network setup

(1) IP Configuration:

There are 2 types of IP configuration: Static IP and DHCP.

Static IP: Preset or manually modified by the user.

DHCP: Automatically updated by the server. There has to be a server on the LAN.

IP	Explanation
Static	The user manually enters the IP address, netmask and
DHCP	The polled DHCP offers the IP address, netmask and

(2) IP address:

IP address is the location of equipment on the network. Every equipment connected to the network has to have an IP address. Incorrect IP address will result in connection failure. Consult you ISP for how to set up the IP address. **The default IP for DTMEXX is 192.168.1.5.**

(3) Netmask:

Netmask is an important parameter for setting up the subnet, used for seeing if the destination IP and local equipment are in the same subnet. If not, the equipment will send the packet to the gateway, and the gateway will send the packet to another subnet. Incorrect setting may cause the destination equipment unable to communicate to DTMEXX. To see if your setting is correct, conduct bitwise AND operations between your IP and netmask and destination IP and netmask. If the two values obtained are the same, the two IPs are in the same subnet. **The default netmask of DTMEXX is 255.255.255.0.**

(4) Gateway:

Gateway is the window for two different subnets, allowing two equipments in different subnets to communicate with each other. For example, if the LAN has to be connected to the WAN, it will need a gateway to bridge the communication. The IP of the gateway has to be in the same subnet as DTMEXX. **The default gateway of DTMEXX is 192.168.1.1.**

7.3.3 Network Settings

The first step for all the equipment to connect to the network is to have its own IP (Internet Protocol) address. The IP address is like a number for every device on the network to be identified.

■ Setting up static IP of the PC

1. Go to Control Panel → Network and Sharing Center → click the connected area connection.

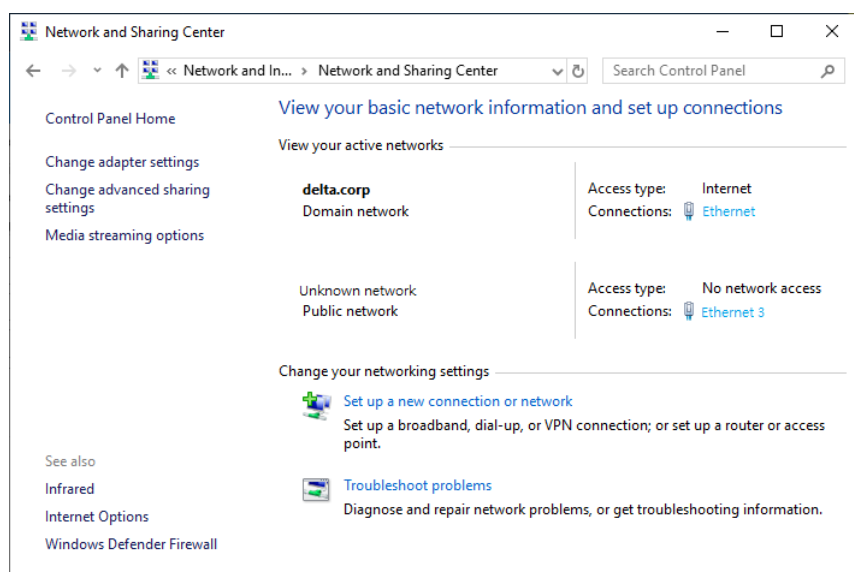

2. Click to enter the area connection content, as shown in the figure.

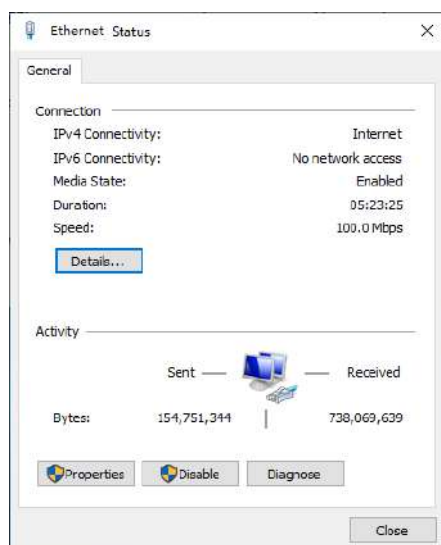

3. Click to enter the contents of **Internet Protocol Version 4 (TCP / IP)**, as shown in the figure.

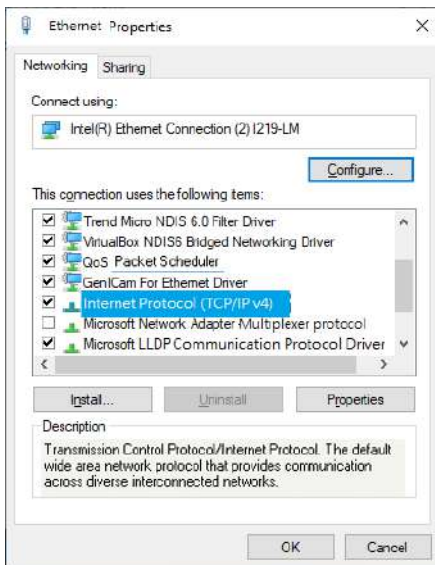

4. The IP address can be set to **192.168.0.1**. After clicking "OK", the IP address setting of the PC is completed.

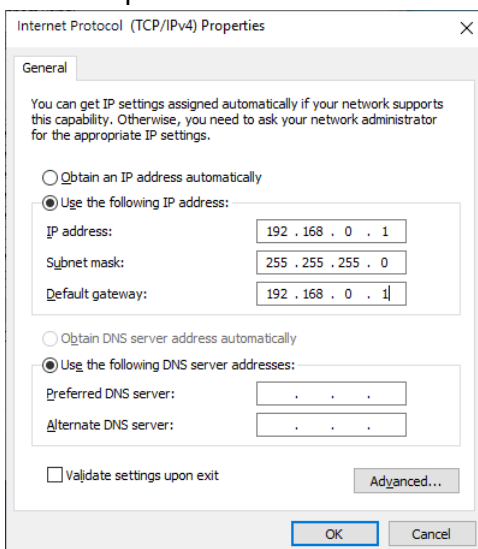

7.3.4 IP Filter

The IP filter is used for restricting the connection of the network in case some uncertain IP will cause errors. Only the IP set within the allowed range can establish the connection; other IPs will be rejected.

■ Setting up IP filter

DTMEXX

Overview | Basic | IP Filter | Security

Enable IP Filter (Only the IP address listed below are allowed to access)

IP Filter Setup

No.	Begin IP Address	End IP Address
1.	0 . 0 . 0 . 0	0 . 0 . 0 . 0
2.	0 . 0 . 0 . 0	0 . 0 . 0 . 0
3.	0 . 0 . 0 . 0	0 . 0 . 0 . 0
4.	0 . 0 . 0 . 0	0 . 0 . 0 . 0
5.	0 . 0 . 0 . 0	0 . 0 . 0 . 0
6.	0 . 0 . 0 . 0	0 . 0 . 0 . 0
7.	0 . 0 . 0 . 0	0 . 0 . 0 . 0
8.	0 . 0 . 0 . 0	0 . 0 . 0 . 0

OK Cancel Apply

1. Enable IP Filter:

Check the box to enable IP filter.

2. Begin IP Address:

The beginning IP addresses that are allowed to establish a connection. Max. 8 IPs are allowed.

3. End IP Address:

The ending IP addresses that are allowed to establish a connection. Max. 8 IPs are allowed.

7.3.5 Security

After you set up all the functions and network environment for DTMEXX, to prevent the set values from being modified, you can set up passwords to lock the settings in DTMEXX.

■ Setting up password

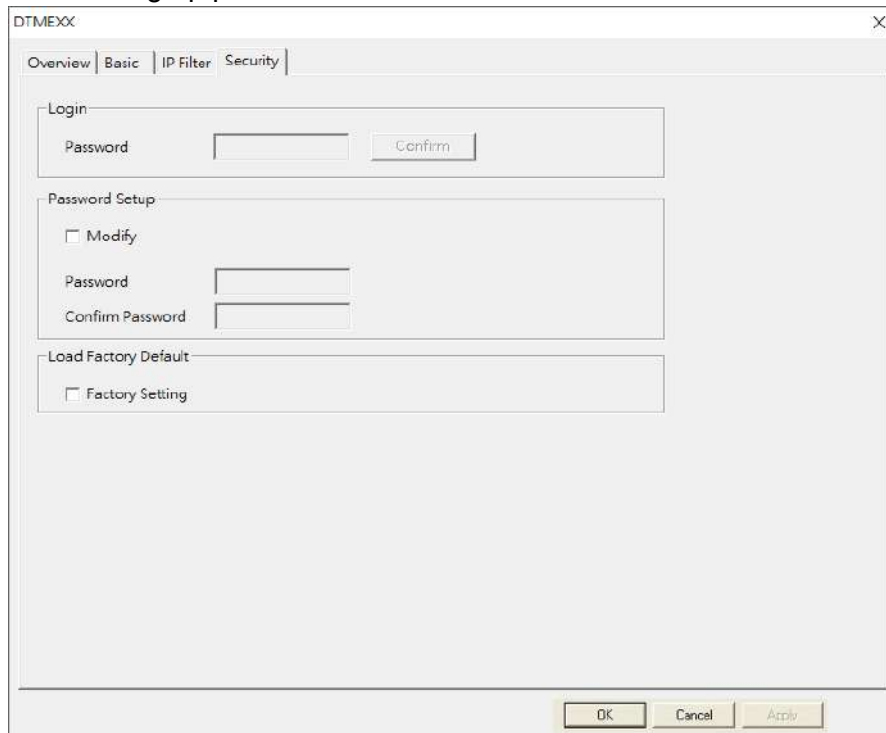

The screenshot shows the DTMEXX Security settings window. It has a title bar with 'DTMEXX' and a close button. Below the title bar are four tabs: 'Overview', 'Basic', 'IP Filter', and 'Security'. The 'Security' tab is selected. The window contains three main sections: 'Login', 'Password Setup', and 'Load Factory Default'. The 'Login' section has a 'Password' input field and a 'Confirm' button. The 'Password Setup' section has a 'Modify' checkbox, a 'Password' input field, and a 'Confirm Password' input field. The 'Load Factory Default' section has a 'Factory Setting' checkbox. At the bottom of the window are three buttons: 'OK', 'Cancel', and 'Apply'.

1. Password Setup:

Check the box to modify the password.

2. Password:

Max. 4 characters. Leave it blank to disable the password function.

3. Confirm password:

Enter the new password again.

Note:

Once the password is locked, all the pages cannot be set up unless you unlock the password.

7.3.6 Returning to Default Settings

For the setting of DTME, if you want to clear all the previous settings and return to the default settings, you can check the option of returning to default settings on the page of returning to default settings.

■ Setting up factory setting

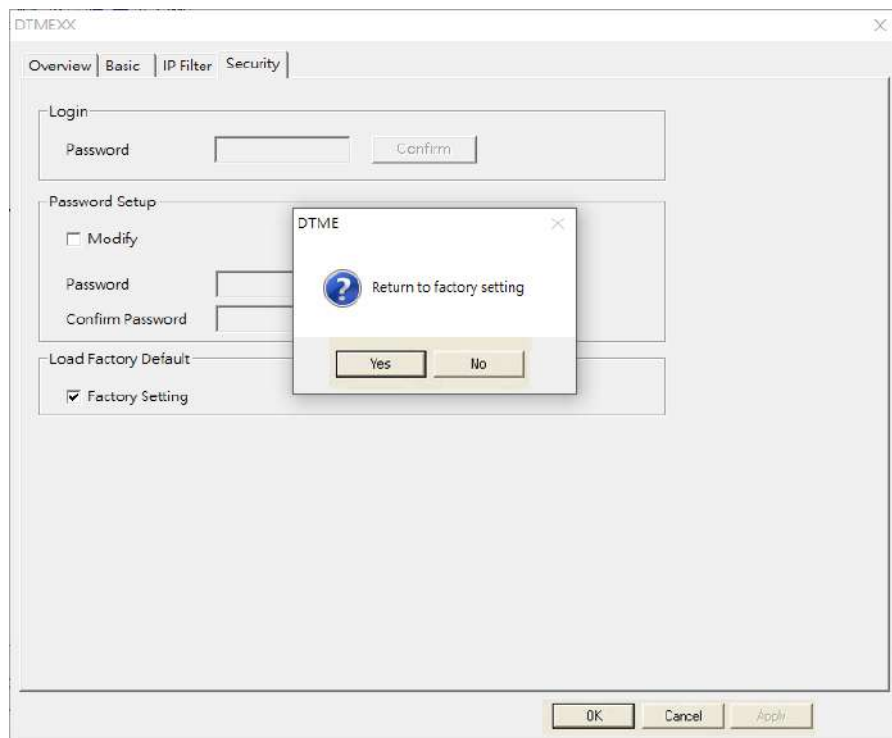

Check the “**Factory Setting**” box and click “**Yes**” to reset all the settings of **DTMEXX** to default settings.

7.3.7 Application Examples

■ Set up and Clear Password

Application	Using DCISoft to set up and clear the password in DTMEXX
Steps	(1) Set up password in DTMEXX. (2) Unlock DTMEXX. (3) Clear password in DTMEXX.

1. See 7.3.1 for the connection and communication settings.
2. Open the setup pages for **DTMEXX** and switch to “**Security**” page.

The screenshot shows the DTMEXX configuration window with the 'Security' tab selected. The window contains three main sections: 'Login', 'Password Setup', and 'Load Factory Default'. The 'Login' section has a 'Password' input field and a 'Confirm' button. The 'Password Setup' section has a 'Modify' checkbox, a 'Password' input field, and a 'Confirm Password' input field. The 'Load Factory Default' section has a 'Factory Setting' checkbox. At the bottom of the window are 'OK', 'Cancel', and 'Apply' buttons.

Chapter 7:Appendix

3. Check **“Modify”** and enter password **“1234”** into the **“Password”** and **“Confirm Password”** columns. Click **“Apply”** to save the password.

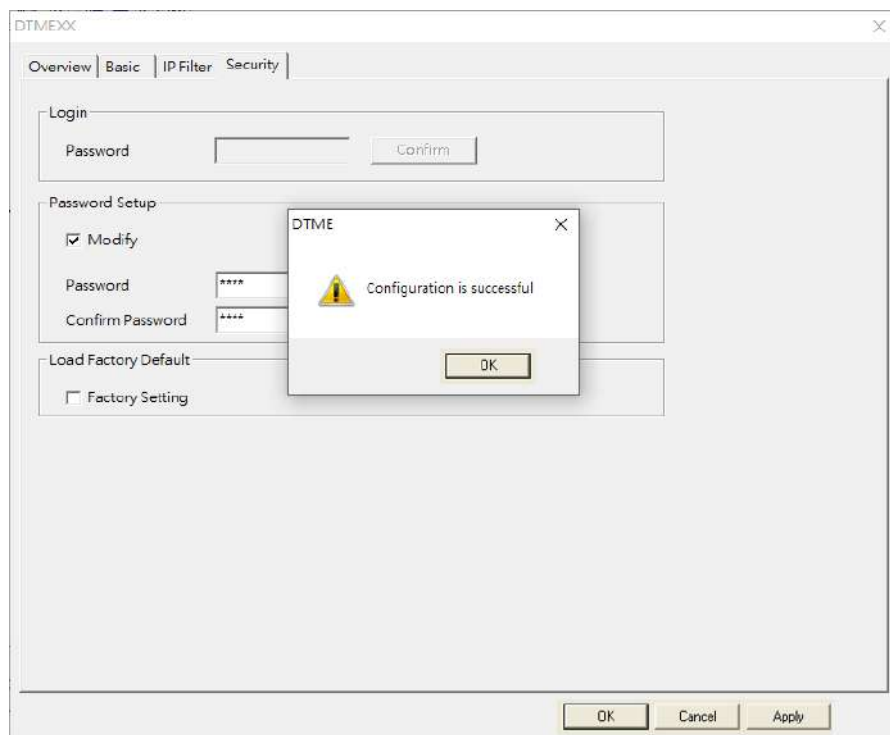

4. Reopen the setup page, and all the settings are now locked by password. Enter the password and click **“OK”**.

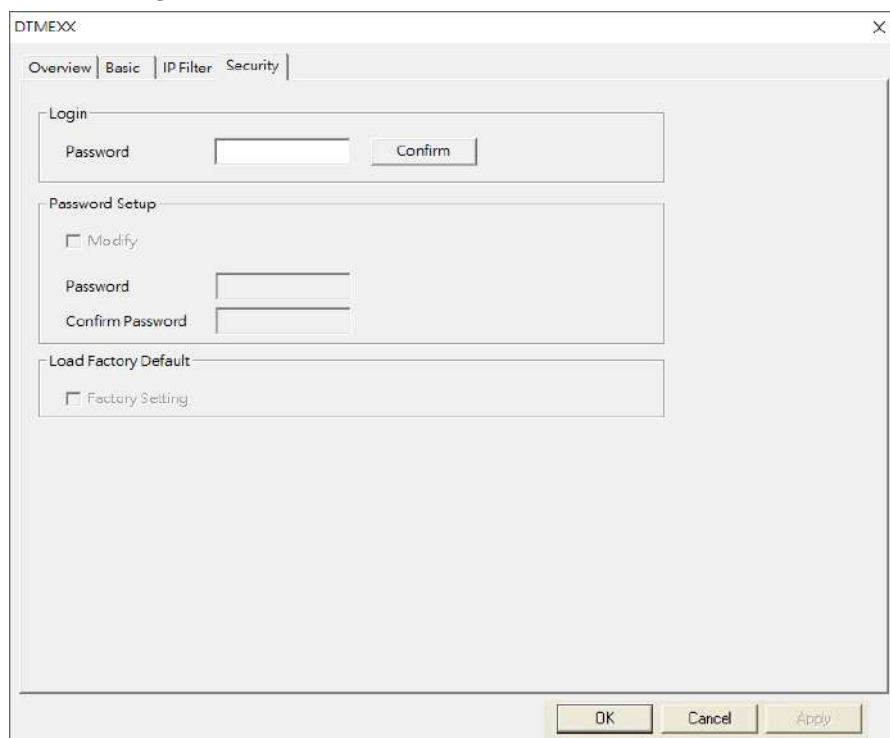

5. Enter the password to unlock the settings and modify parameters. If you close the setup page now, the settings will remain being locked.

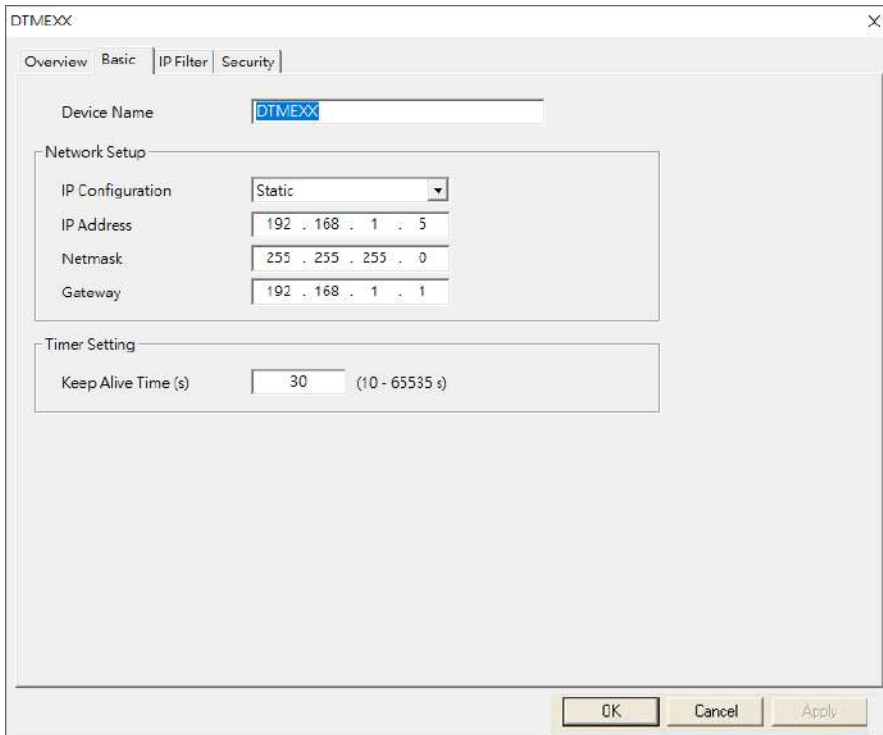

The screenshot shows the DTMEXX configuration window with the 'Security' tab selected. The 'Device Name' field contains 'DTMEXX'. Under 'Network Setup', 'IP Configuration' is set to 'Static'. The IP Address is '192 . 168 . 1 . 5', Netmask is '255 . 255 . 255 . 0', and Gateway is '192 . 168 . 1 . 1'. Under 'Timer Setting', 'Keep Alive Time (s)' is set to '30' (range 10 - 65535 s). Buttons for 'OK', 'Cancel', and 'Apply' are at the bottom.

6. To clear the password, leave the password columns blank and click “**Apply**”.

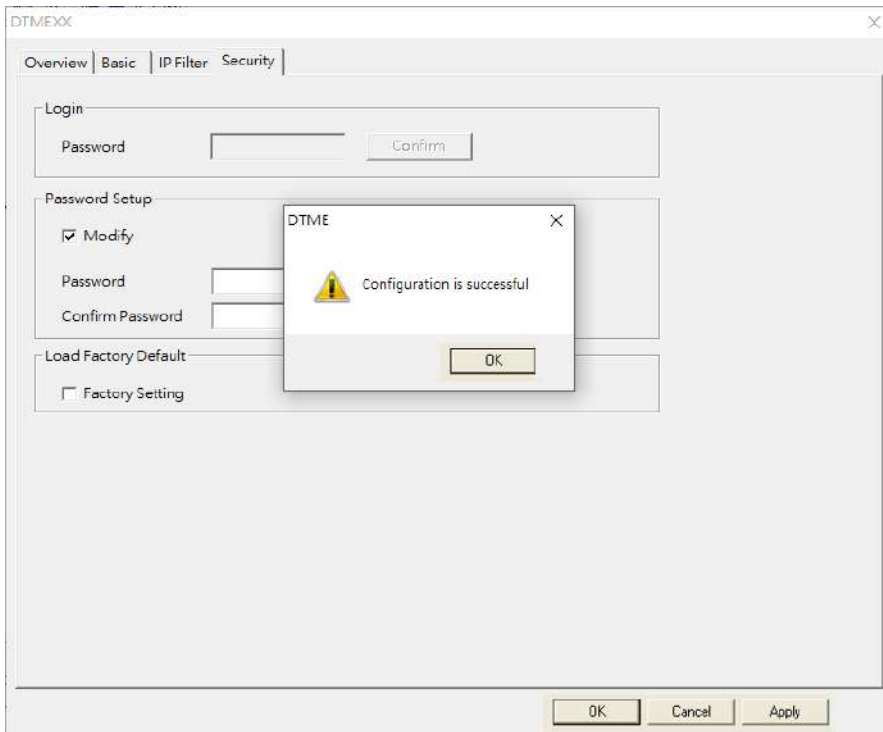

The screenshot shows the DTMEXX configuration window with the 'Security' tab selected. The 'Login' section has an empty 'Password' field and a 'Confirm' button. The 'Password Setup' section has 'Modify' checked, and empty 'Password' and 'Confirm Password' fields. The 'Load Factory Default' section has 'Factory Setting' unchecked. A dialog box titled 'DTME' with a warning icon and the text 'Configuration is successful' is overlaid on the window. Buttons for 'OK', 'Cancel', and 'Apply' are at the bottom.

7. After the password is cleared, you can then modify parameters.

Chapter 7:Appendix

■ IP Filter Protection

Application	Setting up IP filter protection
Steps	(1) IP of DTMEXX: 192.168.0.4 (2) Only allow 192.168.0.7 and 172.16.0.1~172.16.0.254 to establish

1. See 7.3.1 for the connection and communication settings.
2. Open the setup page for **DTMEXX** and switch to “**IP Filter**” page.
3. Check “**Enable IP Filter**”. Enter “**192.168.0.7**” in No. 1 Begin IP Address and “**192.168.0.7**” in End IP Address.

DTMEXX

Overview | Basic | IP Filter | Security

Enable IP Filter (Only the IP address listed below are allowed to access)

IP Filter Setup

No.	Begin IP Address	End IP Address
1.	192 . 168 . 0 . 7	192 . 168 . 0 . 7
2.	0 . 0 . 0 . 0	0 . 0 . 0 . 0
3.	0 . 0 . 0 . 0	0 . 0 . 0 . 0
4.	0 . 0 . 0 . 0	0 . 0 . 0 . 0
5.	0 . 0 . 0 . 0	0 . 0 . 0 . 0
6.	0 . 0 . 0 . 0	0 . 0 . 0 . 0
7.	0 . 0 . 0 . 0	0 . 0 . 0 . 0
8.	0 . 0 . 0 . 0	0 . 0 . 0 . 0

OK Cancel Apply

4. Enter “**172.16.0.1**” in No.2 Begin IP Address and “**172.16.0.254**” in End IP Address. Click “**Apply**”, then only equipment within the allowed IP range can be connected.

DTMEXX

Overview | Basic | IP Filter | Security

Enable IP Filter (Only the IP address listed below are allowed to access)

IP Filter Setup

No.	Begin IP Address	End IP Address
1.	192 . 168 . 0 . 7	192 . 168 . 0 . 7
2.	0 . 0 . 0 . 0	0 . 0 . 0 . 0
3.	0 . 0 . 0 . 0	0 . 0 . 0 . 0
4.	0 . 0 . 0 . 0	0 . 0 . 0 . 0
5.	0 . 0 . 0 . 0	0 . 0 . 0 . 0
6.	0 . 0 . 0 . 0	0 . 0 . 0 . 0
7.	0 . 0 . 0 . 0	0 . 0 . 0 . 0
8.	0 . 0 . 0 . 0	0 . 0 . 0 . 0

OK Cancel Apply

5. Enter “**172.16.0.1**” in No.2 Begin IP Address and “**172.16.0.254**” in End IP Address. Click “**Apply**”, then only equipment within the allowed IP range can be connected.

DTMEXX

Overview | Basic | IP Filter | Security

Enable IP Filter (Only the IP address listed below are allowed to access)

IP Filter Setup

No.	Begin IP Address	End IP Address
1.	192 . 168 . 0 . 7	192 . 168 . 0 . 7
2.	172 . 16 . 0 . 1	172 . 16 . 0 . 255
3.	0 . 0 . 0 . 0	0 . 0 . 0 . 0
4.	0 . 0 . 0 . 0	0 . 0 . 0 . 0
5.	0 . 0 . 0 . 0	0 . 0 . 0 . 0
6.	0 . 0 . 0 . 0	0 . 0 . 0 . 0
7.	0 . 0 . 0 . 0	0 . 0 . 0 . 0
8.	0 . 0 . 0 . 0	0 . 0 . 0 . 0

OK Cancel Apply

7.4 Product Service

In order to facilitate the setting of parameters, this company provides free DTM Soft communications setting software; please download from the Delta website:

1. Delta website: <http://www.deltaww.com/>
2. Click on **Product service -> Industrial automation**
3. Pull down the menu in the lower right corner, and click on **Download Center**
 - 1st level menu: Industrial automation
 - 2nd level menu: Temperature controller
 - 3rd level menu: **DTM**After selecting **Software** among **download categories**, press **Begins search**
This will let you download the **DTM Soft** installation file

For more temperature control product data and product Q&A, visit the Delta websites download area:

<http://www.deltaww.com/> or visit our local service windows located worldwide.