

# DVP-SS2

## Instruction Sheet

安 裝 說 明

安 裝 說 明

Programmable Logic Controller

可程式控制器

可編程控制器

DVP-0160030-01  
20200828



Thank you for choosing Delta DVP-SS2 series PLCs. DVP-SS2 series PLCs include one 12-point PLC, two 14-point PLCs, and three 28-point PLCs. A DVP-SS2 series PLC provides various instructions, and the size of the program memory in it is 8k steps. It is able to connect to all DVP-S series extension modules, including digital I/O (max. 480 I/O points) and analog modules (for A/D, D/A conversion and temperature measurement). 4 groups of high-speed (10kHz) pulse output satisfy all kinds of applications. DVP-SS2 is small in size, and can be installed easily. Users do not have to install any batteries in DVP-SS2 series PLCs. The PLC programs and the latched data are stored in the flash memories.

- EN ✘ DVP-SS2 is an OPEN-TYPE device. It should be installed in a control cabinet free of airborne dust, humidity, electric shock and vibration. To prevent non-maintenance staff from operating DVP-SS2, or to prevent an accident from damaging DVP-SS2, the control cabinet in which DVP-SS2 is installed should be equipped with a safeguard. For example, the control cabinet in which DVP-SS2 is installed can be unlocked with a special tool or key.
- EN ✘ DO NOT connect AC power to any of I/O terminals, otherwise serious damage may occur. Please check all wiring again before DVP-SS2 is powered up. After DVP-SS2 is disconnected, Do NOT touch any terminals in a minute. Make sure that the ground terminal ⊕ on DVP-SS2 is correctly grounded in order to prevent electromagnetic interference.
- FR ✘ DVP-SS2 est un module OUVERT. Il doit être installé que dans une enceinte protectrice (boîtier, armoire, etc.) saine, dépourvue de poussière, d'humidité, de vibrations et hors d'atteinte des chocs électriques. La protection doit éviter que les personnes non habilitées à la maintenance puissent accéder à l'appareil (par exemple, une clé ou un outil doivent être nécessaire pour ouvrir a protection).
- FR ✘ Ne pas appliquer la tension secteur sur les bornes d'entrées/Sorties, ou l'appareil DVP-SS2 pourra être endommagé. Merci de vérifier encore une fois le câblage avant la mise sous tension du DVP-SS2. Lors de la déconnection de l'appareil, ne pas toucher les connecteurs dans la minute suivante. Vérifier que la terre est bien reliée au connecteur de terre ⊕ afin d'éviter toute interférence électromagnétique.

## ■ Product Profile & Dimension

### A. DVP12SS2/14SS2

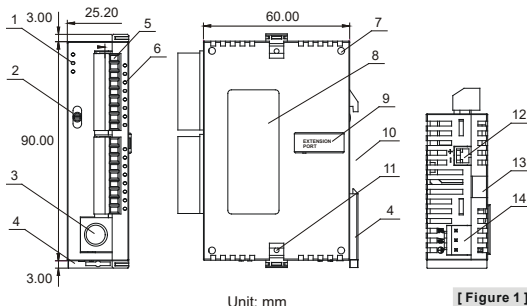

[ Figure 1 ]

1. POWER, RUN, ERROR indicator	8. Nameplate
2. RUN/STOP switch	9. Extension port
3. I/O port for program communication (RS-232)	10. DIN rail mounting slot (35mm)
4. DIN rail clip	11. Extension unit clip
5. I/O terminals	12. RS-485 communication port
6. I/O point indicator	13. Mounting rail for extension module
7. Mounting hole for extension module	14. DC power input

## B. DVP28SS2

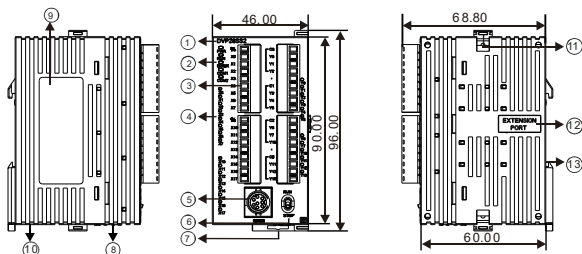

1. Model type	8. RS-485 communication port
2. POWER, RUN, ERROR, COM1 and COM2 status indicator	9. Nameplate
3. I/O terminals	10. DC power input
4. I/O point indicator	11. Extension unit clip
5. I/O port for program communication (RS-232)	12. Extension port
6. RUN/STOP switch	13. DIN rail mounting slot (35mm)
7. DIN rail clip	

## ■ Electrical Specifications

DVP Model	14SS211R	14SS211T	12SS211S	28SS211R	28SS211T 28SS211S
Item					
Power supply voltage	24VDC (-15% ~ 20%) (with counter-connection protection on the polarity of DC input power) DVPPS01(PS02): input 100-240VAC, output 24VDC/1A(PS02: 2A)				
Inrush current	Max. 7.5A@24VDC				
Fuse capacity	1.85A/30VDC, Polyswitch				
Power consumption	1.8W	1.5W		3.6W	1.7W
Power protection	With counter-connection protection on the polarity of DC input power				
Operation environment	Free of corrosive gas				
Installation position	Inside the control box				
Pollution rating	2				
Protection rating	IP20				
Over voltage tolerance limit	1,500VAC (Primary-secondary), 1,500VAC (Primary-PE), 500VAC (Secondary-PE)				
Insulation resistance	> 5MΩ (all I/O point-to-ground: 500VDC)				
Noise immunity	ESD (IEC 61131-2, IEC 61000-4-2): 8kV Air Discharge EFT (IEC 61131-2, IEC 61000-4-4): Power Line: 2kV, Digital I/O: 1kV, Analog & Communication I/O: 1kV RS (IEC 61131-2, IEC 61000-4-3): 26MHz ~ 1GHz, 10V/m				
Grounding	The diameter of grounding wire cannot be smaller than the wire diameter of terminals L and N (All DVP units should be grounded directly to the ground pole).				
Operation / storage	Operation: 0°C ~ 55°C (temp.), 5 ~ 95% (humidity), no condensation. Storage: -25°C ~ 70°C (temp.), 5 ~ 95% (humidity), no condensation.				
Vibration / shock resistance	International standards: IEC61131-2, IEC 68-2-6 (TEST Fc)/IEC61131-2 & IEC 68-2-27 (TEST Ea)				
Atmospheric pressure	Operation: 1080 ~ 795hPa (Equivalent to -1000 ~ 2000 feet above sea level) Storage: 1080 ~ 660hPa (Equivalent to -1000 ~ 3500 feet above sea level)				
Weight (g)	97g	82.5g	90g	177g	155g(T)/ 151g(S)

Items	DVP Model	Input Point (single common port input)		
		12SS2, 14SS2, 28SS2		28SS2
Input No.		X0 ~ X3	X4 ~ X7	X10 ~ X17
Input type		DC (SINK or SOURCE)		
Input Current ( $\pm 10\%$ )		24VDC (-15% ~ 20%), 5mA		
Input impedance		4.7k $\Omega$		
Max. frequency		20kHz	10kHz	1kHz <sup>#3</sup>
Action level	Off→On	> 15VDC		
	On→Off	< 5VDC		
Response time	Off→On	< 10 $\mu$ s	< 20 $\mu$ s	< 200 $\mu$ s
	On→Off	< 20 $\mu$ s	< 50 $\mu$ s	< 200 $\mu$ s
Filter time		X0 ~ X7 adjustable within 0 ~ 20ms by D1020 (Default: 10ms) X10 ~ X17 adjustable within 0 ~ 20ms by D1021 (Default: 10ms)		

Items	Spec.	Output Point		
		Relay	Transistor (NPN & PNP)	
Output No.		Y0 ~ Y7, Y10 ~ Y13	Y0 ~ Y3	Y4 ~ Y7, Y10 ~ Y13
Max. frequency		1Hz	10kHz	1kHz <sup>#3</sup>
Working voltage		250VAC, < 30VDC	5 ~ 30VDC <sup>#1</sup>	
Max. load	Resistive	1.5A/1 point (5A/COM)	0.5A/1 point (3A/COM)	
	Inductive	<sup>#2</sup>	15W (30VDC)	
	Lamp	20WDC/100WAC	2.5W (30VDC)	
Response time	Off→On	Approx. 10ms	20 $\mu$ s	100 $\mu$ s
	On→Off		30 $\mu$ s	100 $\mu$ s

#1: UP, ZP must work with external auxiliary power supply 24VDC (-15% ~ +20%), rated consumption approx. 10mA/point.

#2: Life curves

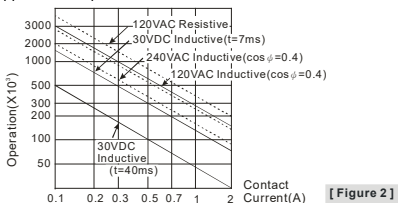

#3: The max input/output frequency is influenced by the actual PLC scan time.

## ■ I/O Configuration

14SS211R	14SS211T	12SS211S	28SS211R	28SS211T	28SS211S																																																																																																																					
Relay 8IN/6OUT	Transistor (NPN) 8IN/6OUT	Transistor (PNP) 8IN/4OUT	Relay 16IN/12OUT	Transistor (NPN/PNP) 16IN/12OUT																																																																																																																						
DC (Sink or Source)																																																																																																																										
<table border="1"> <tr><td>S/S</td></tr><tr><td>X0</td></tr><tr><td>X1</td></tr><tr><td>X2</td></tr><tr><td>X3</td></tr><tr><td>X4</td></tr><tr><td>X5</td></tr><tr><td>X6</td></tr><tr><td>X7</td></tr><tr><td>C0</td></tr><tr><td>Y0</td></tr><tr><td>Y1</td></tr><tr><td>Y2</td></tr><tr><td>●</td></tr><tr><td>C1</td></tr><tr><td>Y3</td></tr><tr><td>Y4</td></tr><tr><td>Y5</td></tr> </table>	S/S	X0	X1	X2	X3	X4	X5	X6	X7	C0	Y0	Y1	Y2	●	C1	Y3	Y4	Y5	<table border="1"> <tr><td>S/S</td></tr><tr><td>X0</td></tr><tr><td>X1</td></tr><tr><td>X2</td></tr><tr><td>X3</td></tr><tr><td>X4</td></tr><tr><td>X5</td></tr><tr><td>X6</td></tr><tr><td>X7</td></tr><tr><td>UP</td></tr><tr><td>ZP</td></tr><tr><td>●</td></tr><tr><td>Y0</td></tr><tr><td>Y1</td></tr><tr><td>Y2</td></tr><tr><td>Y3</td></tr><tr><td>Y4</td></tr><tr><td>Y5</td></tr> </table>	S/S	X0	X1	X2	X3	X4	X5	X6	X7	UP	ZP	●	Y0	Y1	Y2	Y3	Y4	Y5	<table border="1"> <tr><td>S/S</td></tr><tr><td>X0</td></tr><tr><td>X1</td></tr><tr><td>X2</td></tr><tr><td>X3</td></tr><tr><td>X4</td></tr><tr><td>X5</td></tr><tr><td>X6</td></tr><tr><td>X7</td></tr><tr><td>UP</td></tr><tr><td>ZP</td></tr><tr><td>●</td></tr><tr><td>DA</td></tr><tr><td>PWM</td></tr><tr><td>Y0</td></tr><tr><td>Y1</td></tr><tr><td>Y2</td></tr><tr><td>Y3</td></tr> </table>	S/S	X0	X1	X2	X3	X4	X5	X6	X7	UP	ZP	●	DA	PWM	Y0	Y1	Y2	Y3	<table border="1"> <tr><td>S/S</td></tr><tr><td>X0</td></tr><tr><td>X1</td></tr><tr><td>X2</td></tr><tr><td>X3</td></tr><tr><td>X4</td></tr><tr><td>X5</td></tr><tr><td>X6</td></tr><tr><td>X7</td></tr><tr><td>S/S</td></tr><tr><td>X10</td></tr><tr><td>X11</td></tr><tr><td>X12</td></tr><tr><td>X13</td></tr><tr><td>X14</td></tr><tr><td>X15</td></tr><tr><td>X16</td></tr><tr><td>X17</td></tr><tr><td>C0</td></tr><tr><td>Y0</td></tr><tr><td>Y1</td></tr><tr><td>Y2</td></tr><tr><td>●</td></tr><tr><td>C1</td></tr><tr><td>Y11</td></tr><tr><td>Y12</td></tr><tr><td>Y13</td></tr> </table>	S/S	X0	X1	X2	X3	X4	X5	X6	X7	S/S	X10	X11	X12	X13	X14	X15	X16	X17	C0	Y0	Y1	Y2	●	C1	Y11	Y12	Y13	<table border="1"> <tr><td>S/S</td></tr><tr><td>X0</td></tr><tr><td>X1</td></tr><tr><td>X2</td></tr><tr><td>X3</td></tr><tr><td>X4</td></tr><tr><td>X5</td></tr><tr><td>X6</td></tr><tr><td>X7</td></tr><tr><td>S/S</td></tr><tr><td>X10</td></tr><tr><td>X11</td></tr><tr><td>X12</td></tr><tr><td>X13</td></tr><tr><td>X14</td></tr><tr><td>X15</td></tr><tr><td>X16</td></tr><tr><td>X17</td></tr> </table>	S/S	X0	X1	X2	X3	X4	X5	X6	X7	S/S	X10	X11	X12	X13	X14	X15	X16	X17	<table border="1"> <tr><td>UP0</td></tr><tr><td>ZP0</td></tr><tr><td>Y0</td></tr><tr><td>Y1</td></tr><tr><td>Y2</td></tr><tr><td>Y3</td></tr><tr><td>Y4</td></tr><tr><td>Y5</td></tr><tr><td>Y6</td></tr><tr><td>Y7</td></tr><tr><td>●</td></tr><tr><td>UP1</td></tr><tr><td>ZP1</td></tr><tr><td>Y10</td></tr><tr><td>Y11</td></tr><tr><td>Y12</td></tr><tr><td>Y13</td></tr><tr><td>●</td></tr> </table>	UP0	ZP0	Y0	Y1	Y2	Y3	Y4	Y5	Y6	Y7	●	UP1	ZP1	Y10	Y11	Y12	Y13	●
S/S																																																																																																																										
X0																																																																																																																										
X1																																																																																																																										
X2																																																																																																																										
X3																																																																																																																										
X4																																																																																																																										
X5																																																																																																																										
X6																																																																																																																										
X7																																																																																																																										
C0																																																																																																																										
Y0																																																																																																																										
Y1																																																																																																																										
Y2																																																																																																																										
●																																																																																																																										
C1																																																																																																																										
Y3																																																																																																																										
Y4																																																																																																																										
Y5																																																																																																																										
S/S																																																																																																																										
X0																																																																																																																										
X1																																																																																																																										
X2																																																																																																																										
X3																																																																																																																										
X4																																																																																																																										
X5																																																																																																																										
X6																																																																																																																										
X7																																																																																																																										
UP																																																																																																																										
ZP																																																																																																																										
●																																																																																																																										
Y0																																																																																																																										
Y1																																																																																																																										
Y2																																																																																																																										
Y3																																																																																																																										
Y4																																																																																																																										
Y5																																																																																																																										
S/S																																																																																																																										
X0																																																																																																																										
X1																																																																																																																										
X2																																																																																																																										
X3																																																																																																																										
X4																																																																																																																										
X5																																																																																																																										
X6																																																																																																																										
X7																																																																																																																										
UP																																																																																																																										
ZP																																																																																																																										
●																																																																																																																										
DA																																																																																																																										
PWM																																																																																																																										
Y0																																																																																																																										
Y1																																																																																																																										
Y2																																																																																																																										
Y3																																																																																																																										
S/S																																																																																																																										
X0																																																																																																																										
X1																																																																																																																										
X2																																																																																																																										
X3																																																																																																																										
X4																																																																																																																										
X5																																																																																																																										
X6																																																																																																																										
X7																																																																																																																										
S/S																																																																																																																										
X10																																																																																																																										
X11																																																																																																																										
X12																																																																																																																										
X13																																																																																																																										
X14																																																																																																																										
X15																																																																																																																										
X16																																																																																																																										
X17																																																																																																																										
C0																																																																																																																										
Y0																																																																																																																										
Y1																																																																																																																										
Y2																																																																																																																										
●																																																																																																																										
C1																																																																																																																										
Y11																																																																																																																										
Y12																																																																																																																										
Y13																																																																																																																										
S/S																																																																																																																										
X0																																																																																																																										
X1																																																																																																																										
X2																																																																																																																										
X3																																																																																																																										
X4																																																																																																																										
X5																																																																																																																										
X6																																																																																																																										
X7																																																																																																																										
S/S																																																																																																																										
X10																																																																																																																										
X11																																																																																																																										
X12																																																																																																																										
X13																																																																																																																										
X14																																																																																																																										
X15																																																																																																																										
X16																																																																																																																										
X17																																																																																																																										
UP0																																																																																																																										
ZP0																																																																																																																										
Y0																																																																																																																										
Y1																																																																																																																										
Y2																																																																																																																										
Y3																																																																																																																										
Y4																																																																																																																										
Y5																																																																																																																										
Y6																																																																																																																										
Y7																																																																																																																										
●																																																																																																																										
UP1																																																																																																																										
ZP1																																																																																																																										
Y10																																																																																																																										
Y11																																																																																																																										
Y12																																																																																																																										
Y13																																																																																																																										
●																																																																																																																										

**Note:** The layout of output terminals on DVP-SS2 is different from that on DVP-SS series.

## ■ Dimension & Installation

Please install the PLC in an enclosure with sufficient space around it to allow heat dissipation, See [Figure 3].

- **Direct Mounting:** Use M4 screw according to the dimension of the product.
- **DIN Rail Mounting:** When mounting the PLC to 35mm DIN rail, be sure to use the retaining clip to stop any side-to-side movement of the PLC and reduce the chance of wires being loose. The retaining clip is at the bottom of the PLC. To secure the PLC to DIN rail, pull down the clip, place it onto the rail and gently push it up. To remove the PLC, pull the retaining clip down with a flat screwdriver and gently remove the PLC from DIN rail.

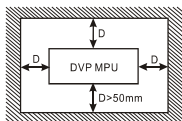

[Figure 3]

## ■ Wiring

Use 22-16AWG (1.5mm) single or multiple core wire on I/O wiring terminals. See the figure in the right hand side for its specification. PLC terminal screws should be tightened to 1.90 kg-cm (1.65 in-lbs) and please use only 60/75°C copper conductor.

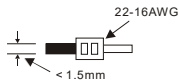

1. DO NOT wire empty terminal. DO NOT place the I/O signal cable in the same wiring circuit.
2. DO NOT drop tiny metallic conductor into the PLC while screwing and wiring. Tear off the sticker on the heat dissipation hole for preventing alien substances from dropping in to ensure normal heat dissipation of the PLC.

## ◆ Power Supply

The power input of DVP-SS2 is DC. When operating DVP-SS2, please note the following points:

1. The power is connected to two terminals, 24VDC and 0V, and the range of power is 20.4 ~ 28.8VDC. If the power voltage is less than 20.4VDC, the PLC will stop running, all outputs will go "Off", and the ERROR indicator will start to blink continuously.
2. The power shutdown for less than 10ms will not affect the operation of the PLC.

However, the shutdown time that is too long or the drop of power voltage will stop the operation of the PLC, and all outputs will go off. When the power returns to normal status, the PLC will automatically resume the operation. (Please take care of the latched auxiliary relays and registers inside the PLC when doing the programming).

### ◆ Safety Wiring

Since DVP-SS2 is only compatible with DC power supply, Delta's power supply modules (DVPPS01/DVPPS02) are the suitable power supplies for DVP-SS2. We suggest you install the protection circuit at the power supply terminal to protect DVPPS01 or DVPPS02. See the figure below.

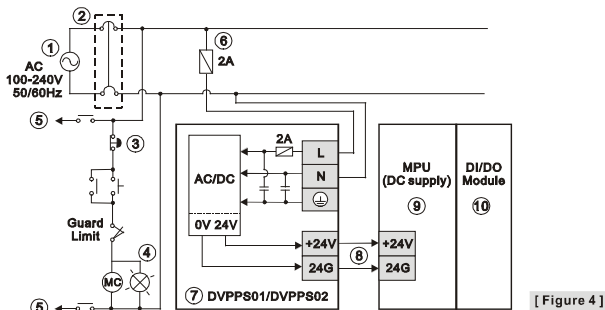

[ Figure 4 ]

- |   |                                  |
|---|----------------------------------|
| ① AC power supply: 100 ~ 240VAC, 50/60Hz  | ② Breaker                        |
| ③ Emergency stop: This button cuts off the system power supply when accidental emergency takes place. |                                  |
| ④ Power indicator   | ⑤ AC power supply load           |
| ⑥ Power supply circuit protection fuse (2A)   | ⑦ DVPPS01/DVPPS02                |
| ⑧ DC power supply output: 24VDC, 500mA  | ⑨ DVP-PLC (main processing unit) |
| ⑩ Digital I/O module  |                                  |

### ◆ Input Point Wiring

There are 2 types of DC inputs, SINK and SOURCE. (See the example below. For detailed point configuration, please refer to the specification of each model.)

#### ● DC Signal IN – SINK mode

Input point loop equivalent circuit

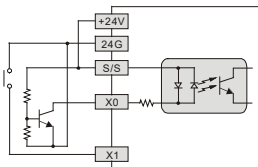

[ Figure 5 ]

#### ● DC Signal IN – SOURCE mode

Input point loop equivalent circuit

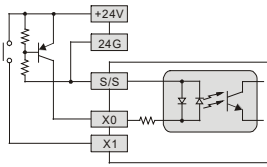

[ Figure 6 ]

### ◆ Output Point Wiring

- DVP-SS2 has two output modules on it, relay and transistor. Be aware of the connection of shared terminals when wiring output terminals.
- Output terminals, Y0, Y1, and Y2, of relay models use C0 common port; Y3, Y4, and Y5 use C1 common port. See [Figure 7]. When the output points are enabled, their corresponding indicators on the front panel will be on.

3. The output terminals Y0~Y5, Y0~Y13 of the transistor (NPN) model are connected to the common terminals UP and ZP. See [Figure 8a]. The output terminals Y0~Y3, Y0~Y13 on the transistor (PNP) model are connected to the common terminals UP and ZP. See [Figure 8b].

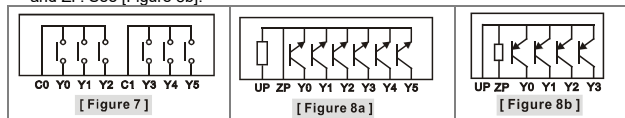

4. Isolation circuit: The optical coupler is used to isolate signals between the circuit inside PLC and input modules.

• Relay (R) output circuit wiring

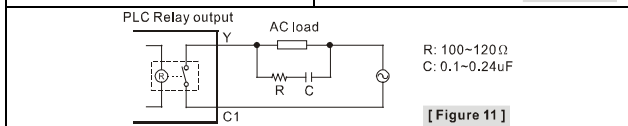
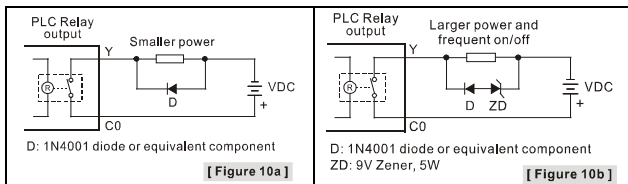
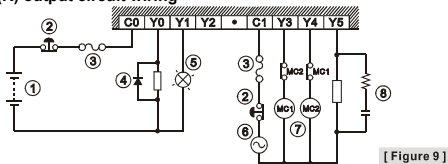

- ① DC power supply  
 ② Emergency stop: Uses external switch  
 ③ Fuse: Uses 5~10A fuse at the shared terminal of output contacts to protect the output circuit  
 ④ Transient voltage suppressor (SB360 3A 60V): Extends the life span of contact.  
 1. Diode suppression of DC load: Used when in smaller power [Figure 10a]  
 2. Diode + Zener suppression of DC load: Used when in larger power and frequent On/Off [Figure 10b]  
 ⑤ Incandescent light (resistive load)  
 ⑥ AC power supply  
 ⑦ Manually exclusive output: For example, Y3 and Y4 control the forward running and reverse running of the motor, forming an interlock for the external circuit, together with the PLC internal program, to ensure safe protection in case of any unexpected errors.  
 ⑧ Absorber: Reduces the interference on AC load [Figure 11]

• Transistor output circuit wiring

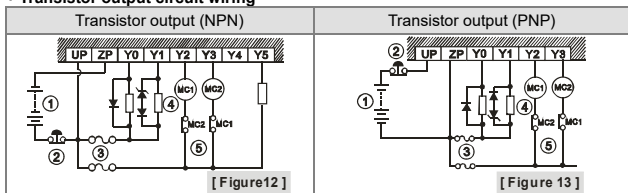

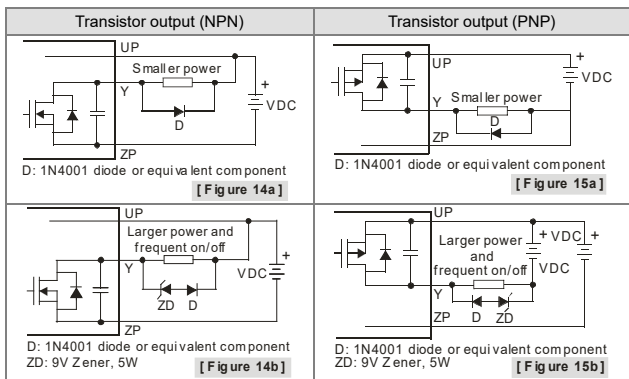

- ① DC power supply      ② Emergency stop      ③ Circuit protection fuse

④ The output of the transistor model is "open collector". If Y0/Y1 is set to pulse output, the output current has to be bigger than 0.1A to ensure normal operation of the model.

1. Diode suppression: Used when in smaller power [Figure 14a] and [Figure 15a]

Diode + Zener suppression: Used when in larger power and frequent On/Off [Figure 14b] and [Figure 15b]

⑤ Manually exclusive output: For example, Y2 and Y3 control the forward running and reverse running of the motor, forming an interlock for the external circuit, together with the PLC internal program, to ensure safe protection in case of any unexpected errors.

#### • PWM DA output circuit wiring (Only for DVP-12SS211S)

Please refer to figure 1 below for more information about wiring.

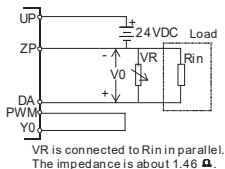

[Figure 1]

Item	Specifications
DA range	0~10VDC
Value range	0~100
Resolution*1	0.1V (1~9V)
Output impedance	2kΩ
Minimum load	1.5kΩ
D/A conversion time	<70ms

\*1: 1~9V is a linear area. The resolution is 0.1V. 0~1V and 9~10V are nonlinear areas. The output probably can not reach the voltage set.

Please refer to the correction formula before you use the PWM DA output function.

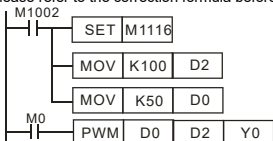

Please refer to the explanation of PWM for more information about setting the time unit for the pulses output by Y0.

Set the pulse cycle to 100μs.

Set the duty cycle of a pulse to 50%.

Set M0 to ON. Adjust the variable resistor so that V0 is 5V, as shown in the curve below. DA output

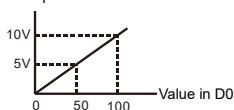



### ◆ RS-485 Wiring

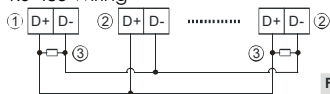

①	Master node
②	Slave node
③	Terminal resistor

Figure 17

Note: 1. Terminal resistors are suggested to be connected to master and the last slave with resistor value of  $120\Omega$ .

2. To ensure communication quality, please apply double shielded twisted pair cable (20AWG) for wiring.

感謝您採用台達 DVP 系列可程式控制器。DVP-SS2 系列提供 12, 14, 28 點 PLC 主機，並具有豐富的指令集及 8k steps 的程式記憶體，可連接薄型全系列 I/O 模組，包含數位輸入輸出（最大輸入輸出擴充點數可達 480 點）、及類比模組（A/D、D/A 轉換及溫度單元）。四個（10kHz）高速脈波輸出可滿足各種應用場合，並且體積小，安裝容易。全系列採用免電池設計，其 PLC 程式與停電保持資料皆運用高速快閃記憶體儲存。

- ✦ 本安裝說明書提供給使用者電氣規格、功能規格、安裝配線之相關注意事項。其他詳細之程式設計及指令說明請見《DVP-SS2 操作手冊：程式篇》，選購之周邊裝置詳細說明請見該產品隨機安裝說明書。
- ✦ 本機為開放型（OPEN TYPE）機殼，因此使用者使用本機時，必須將之安裝於具防塵、防潮及免於電擊/衝擊意外之外殼配線箱內。另必須具備保護措施（如：特殊之工具或鑰匙才可打開）防止非維護人員操作或意外衝擊本體，造成危險及損壞。
- ✦ 交流輸入電源不可連接於輸入 / 出信號端，否則可能造成嚴重損壞，請在上電之前再次確認電源配線。請勿在上電時觸摸任何端子。本體上之接地端子 ⊕ 務必正確的接地，可提高產品抗雜訊能力。

## ■ 尺寸及產品外觀部位介紹

### A. DVP12SS2/14SS2

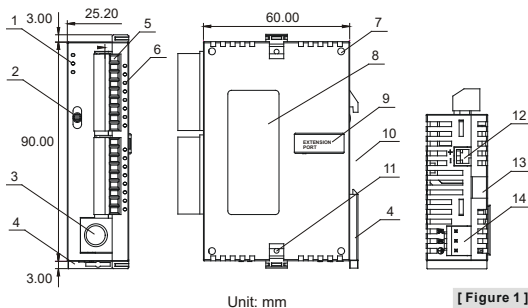

1. 電源、運行、錯誤及狀態指示燈	8. 銘牌
2. RUN / STOP 開關	9. I/O 模組連接口
3. COM1 (RS-232) 通訊口	10. DIN 軌槽 (35mm)
4. DIN 軌固定扣	11. I/O 模組固定扣
5. 輸入 / 輸出端子	12. COM2 (RS-485) 通訊口
6. 輸入 / 輸出點指示燈	13. I/O 模組固定槽
7. I/O 模組定位孔	14. 電源輸入口

## B. DVP28SS2

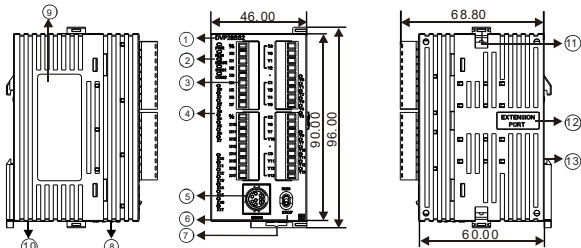

1. 機種名稱	8. COM2 (RS-485) 通訊埠
2. 電源、運行、錯誤、COM1、COM2 狀態指示燈	9. 標籤
3. 輸入/輸出端子	10. 電源輸入口
4. 輸入/輸出指示燈	11. I/O 模組固定扣
5. COM1 (RS-232) 通訊埠	12. I/O 模組連接口
6. RUN/STOP 開關	13. DIN 軌槽 (35mm)
7. DIN 軌固定扣	

## ■ 電氣規格

項目	機種 DVP				
	14SS211R	14SS211T	12SS211S	28SS211R	28SS211T 28SS211S
電源電壓	24VDC (-15% ~ 20%) (具直流輸入電源極性反接保護) DVPPS01(PS02) : 輸入 100-240VAC , 輸出 24VDC/1A (PS02: 2A)				
突入電流	Max. 7.5A@24VDC				
電源保險絲容量	1.85A/30VDC , 可恢復式(Polyswitch)				
消耗電力	1.8W	1.5W		3.6W	1.7W
電源保護	具直流輸入電源極性反接保護				
工作環境	無腐蝕性氣體存在				
安裝位置	控制箱內				
污染等級	2				
防護等級	IP20				
突波電壓耐受量	1,500VAC (Primary-secondary), 1,500VAC (Primary-PE), 500VAC (Secondary-PE)				
絕緣阻抗	> 5MΩ (所有輸出/入點對地之間 500VDC)				
雜訊免疫力	ESD (IEC 61131-2, IEC 61000-4-2): 8kV Air Discharge EFT (IEC 61131-2, IEC 61000-4-4): Power Line: 2kV, Digital I/O: 1kV, Analog & Communication I/O: 1kV RS (IEC 61131-2, IEC 61000-4-3): 26MHz ~ 1GHz, 10V/m				
接地	接地配線之線徑不得小於電源端配線線徑 (多台 PLC 同時使用時, 請務必單點接地)				
操作/儲存環境	操作: 0°C ~ 55°C (溫度) 5 ~ 95% (濕度), 無結露 儲存: -25°C ~ 70°C (溫度) 5 ~ 95% (濕度), 無結露				
耐振動/衝擊	國際標準規範 IEC61131-2, IEC 68-2-6 (TEST Fc)/IEC61131-2 & IEC 68-2-27 (TEST Ea)				

機種 DVP 項目	14SS211R	14SS211T	12SS211S	28SS211R	28SS211T 28SS211S
適用大氣壓	操作：1080 ~ 795hPa (相當於海拔 -1000 ~ 2000 公尺) 儲存：1080 ~ 660hPa (相當於海拔 -1000 ~ 3500 公尺)				
重量	97g	82.5g	90g	177g	155g(T)/ 151g(S)

機種 DVP 項目		輸入點電氣規格 (單端共點方式輸入)		
		12SS2, 14SS2, 28SS2		28SS2
輸入點 No.		X0 ~ X3	X4 ~ X7	X10 ~ X17
輸入接線型式		SINK 或 SOURCE		
輸入信號電壓		24VDC (-15% ~ 20%), 5mA		
輸入點阻抗		4.7k Ohm		
最大輸入頻率		20kHz	10kHz	1kHz <sup>#3</sup>
動作位准	Off→On	> 15VDC		
	On→Off	< 5VDC		
反應時間	Off→On	< 10μs	< 20μs	< 200μs
	On→Off	< 20μs	< 50μs	< 200μs
濾波時間		X0 ~ X7 由 D1020 可做 0 ~ 20ms 調整 (預設：10ms) X10 ~ X17 由 D1021 可做 0 ~ 20ms 調整 (預設：10ms)		

型態與規格 項目		輸出點電氣規格		
		繼電器	電晶體 (NPN & PNP)	
輸出點 No.		Y0 ~ Y7, Y10~Y13	Y0 ~ Y3	Y4 ~ Y7, Y10~Y13
最高交換頻率		1Hz	10kHz	1kHz <sup>#3</sup>
電壓規格		250VAC, < 30VDC	5 ~ 30VDC <sup>#1</sup>	
電流規格	電阻性	1.5A/1 點 (5A/COM)	0.5A/1 點 (3A/COM)	
	電感性	<sup>#2</sup>	15W (30VDC)	
	燈泡	20WDC/100WAC	2.5W (30VDC)	
反應時間	Off→On	約 10ms	20μs	100μs
	On→Off		30μs	100μs

#1：UP, ZP 必須外加輔助電源 24VDC (-15% ~ +20%) 額定消耗約 10mA/點。

#2：生命週期曲線圖請參閱英文版[Figure 2]。

#3：此處最高輸入/輸出頻率會受實際 PLC 掃描時間影響。

## ■ 輸入輸出配置

14SS211R	14SS211T	12SS211S	28SS211R	28SS211T	28SS211S																																																																																																																											
繼電器 8IN/6OUT	電晶體(NPN) 8IN/6OUT	電晶體 (PNP) 8IN/4OUT	繼電器 16IN/12OUT	電晶體(NPN/PNP) 16IN/12OUT																																																																																																																												
直流 (Sink or Source)																																																																																																																																
<table border="1"> <tr><td>S/S</td></tr><tr><td>X0</td></tr><tr><td>X1</td></tr><tr><td>X2</td></tr><tr><td>X3</td></tr><tr><td>X4</td></tr><tr><td>X5</td></tr><tr><td>X6</td></tr><tr><td>X7</td></tr><tr><td>C0</td></tr><tr><td>Y0</td></tr><tr><td>Y1</td></tr><tr><td>Y2</td></tr><tr><td>●</td></tr><tr><td>C1</td></tr><tr><td>Y3</td></tr><tr><td>Y4</td></tr><tr><td>Y5</td></tr></table>	S/S	X0	X1	X2	X3	X4	X5	X6	X7	C0	Y0	Y1	Y2	●	C1	Y3	Y4	Y5	<table border="1"> <tr><td>S/S</td></tr><tr><td>X0</td></tr><tr><td>X1</td></tr><tr><td>X2</td></tr><tr><td>X3</td></tr><tr><td>X4</td></tr><tr><td>X5</td></tr><tr><td>X6</td></tr><tr><td>X7</td></tr><tr><td>UP</td></tr><tr><td>ZP</td></tr><tr><td>●</td></tr><tr><td>Y0</td></tr><tr><td>Y1</td></tr><tr><td>Y2</td></tr><tr><td>Y3</td></tr><tr><td>Y4</td></tr><tr><td>Y5</td></tr></table>	S/S	X0	X1	X2	X3	X4	X5	X6	X7	UP	ZP	●	Y0	Y1	Y2	Y3	Y4	Y5	<table border="1"> <tr><td>S/S</td></tr><tr><td>X0</td></tr><tr><td>X1</td></tr><tr><td>X2</td></tr><tr><td>X3</td></tr><tr><td>X4</td></tr><tr><td>X5</td></tr><tr><td>X6</td></tr><tr><td>X7</td></tr><tr><td>UP</td></tr><tr><td>ZP</td></tr><tr><td>●</td></tr><tr><td>DA</td></tr><tr><td>PWM</td></tr><tr><td>Y0</td></tr><tr><td>Y1</td></tr><tr><td>Y2</td></tr><tr><td>Y3</td></tr></table>	S/S	X0	X1	X2	X3	X4	X5	X6	X7	UP	ZP	●	DA	PWM	Y0	Y1	Y2	Y3	<table border="1"> <tr><td>S/S</td></tr><tr><td>X0</td></tr><tr><td>X1</td></tr><tr><td>X2</td></tr><tr><td>X3</td></tr><tr><td>X4</td></tr><tr><td>X5</td></tr><tr><td>X6</td></tr><tr><td>X7</td></tr><tr><td>S/S</td></tr><tr><td>X10</td></tr><tr><td>X11</td></tr><tr><td>X12</td></tr><tr><td>X13</td></tr><tr><td>X14</td></tr><tr><td>X15</td></tr><tr><td>X16</td></tr><tr><td>X17</td></tr> </table> <table border="1"> <tr><td>C0</td></tr><tr><td>Y0</td></tr><tr><td>Y1</td></tr><tr><td>Y2</td></tr><tr><td>●</td></tr><tr><td>C1</td></tr><tr><td>Y3</td></tr><tr><td>Y4</td></tr><tr><td>Y5</td></tr><tr><td>C2</td></tr><tr><td>Y6</td></tr><tr><td>Y7</td></tr><tr><td>Y10</td></tr><tr><td>Y11</td></tr><tr><td>Y12</td></tr><tr><td>Y13</td></tr> </table>	S/S	X0	X1	X2	X3	X4	X5	X6	X7	S/S	X10	X11	X12	X13	X14	X15	X16	X17	C0	Y0	Y1	Y2	●	C1	Y3	Y4	Y5	C2	Y6	Y7	Y10	Y11	Y12	Y13	<table border="1"> <tr><td>S/S</td></tr><tr><td>X0</td></tr><tr><td>X1</td></tr><tr><td>X2</td></tr><tr><td>X3</td></tr><tr><td>X4</td></tr><tr><td>X5</td></tr><tr><td>X6</td></tr><tr><td>X7</td></tr><tr><td>S/S</td></tr><tr><td>X10</td></tr><tr><td>X11</td></tr><tr><td>X12</td></tr><tr><td>X13</td></tr><tr><td>X14</td></tr><tr><td>X15</td></tr><tr><td>X16</td></tr><tr><td>X17</td></tr> </table> <table border="1"> <tr><td>UP0</td></tr><tr><td>ZP0</td></tr><tr><td>Y0</td></tr><tr><td>Y1</td></tr><tr><td>Y2</td></tr><tr><td>Y3</td></tr><tr><td>Y4</td></tr><tr><td>Y5</td></tr><tr><td>Y6</td></tr><tr><td>Y7</td></tr><tr><td>●</td></tr><tr><td>UP1</td></tr><tr><td>ZP1</td></tr><tr><td>Y10</td></tr><tr><td>Y11</td></tr><tr><td>Y12</td></tr><tr><td>Y13</td></tr><tr><td>●</td></tr> </table>	S/S	X0	X1	X2	X3	X4	X5	X6	X7	S/S	X10	X11	X12	X13	X14	X15	X16	X17	UP0	ZP0	Y0	Y1	Y2	Y3	Y4	Y5	Y6	Y7	●	UP1	ZP1	Y10	Y11	Y12	Y13	●
S/S																																																																																																																																
X0																																																																																																																																
X1																																																																																																																																
X2																																																																																																																																
X3																																																																																																																																
X4																																																																																																																																
X5																																																																																																																																
X6																																																																																																																																
X7																																																																																																																																
C0																																																																																																																																
Y0																																																																																																																																
Y1																																																																																																																																
Y2																																																																																																																																
●																																																																																																																																
C1																																																																																																																																
Y3																																																																																																																																
Y4																																																																																																																																
Y5																																																																																																																																
S/S																																																																																																																																
X0																																																																																																																																
X1																																																																																																																																
X2																																																																																																																																
X3																																																																																																																																
X4																																																																																																																																
X5																																																																																																																																
X6																																																																																																																																
X7																																																																																																																																
UP																																																																																																																																
ZP																																																																																																																																
●																																																																																																																																
Y0																																																																																																																																
Y1																																																																																																																																
Y2																																																																																																																																
Y3																																																																																																																																
Y4																																																																																																																																
Y5																																																																																																																																
S/S																																																																																																																																
X0																																																																																																																																
X1																																																																																																																																
X2																																																																																																																																
X3																																																																																																																																
X4																																																																																																																																
X5																																																																																																																																
X6																																																																																																																																
X7																																																																																																																																
UP																																																																																																																																
ZP																																																																																																																																
●																																																																																																																																
DA																																																																																																																																
PWM																																																																																																																																
Y0																																																																																																																																
Y1																																																																																																																																
Y2																																																																																																																																
Y3																																																																																																																																
S/S																																																																																																																																
X0																																																																																																																																
X1																																																																																																																																
X2																																																																																																																																
X3																																																																																																																																
X4																																																																																																																																
X5																																																																																																																																
X6																																																																																																																																
X7																																																																																																																																
S/S																																																																																																																																
X10																																																																																																																																
X11																																																																																																																																
X12																																																																																																																																
X13																																																																																																																																
X14																																																																																																																																
X15																																																																																																																																
X16																																																																																																																																
X17																																																																																																																																
C0																																																																																																																																
Y0																																																																																																																																
Y1																																																																																																																																
Y2																																																																																																																																
●																																																																																																																																
C1																																																																																																																																
Y3																																																																																																																																
Y4																																																																																																																																
Y5																																																																																																																																
C2																																																																																																																																
Y6																																																																																																																																
Y7																																																																																																																																
Y10																																																																																																																																
Y11																																																																																																																																
Y12																																																																																																																																
Y13																																																																																																																																
S/S																																																																																																																																
X0																																																																																																																																
X1																																																																																																																																
X2																																																																																																																																
X3																																																																																																																																
X4																																																																																																																																
X5																																																																																																																																
X6																																																																																																																																
X7																																																																																																																																
S/S																																																																																																																																
X10																																																																																																																																
X11																																																																																																																																
X12																																																																																																																																
X13																																																																																																																																
X14																																																																																																																																
X15																																																																																																																																
X16																																																																																																																																
X17																																																																																																																																
UP0																																																																																																																																
ZP0																																																																																																																																
Y0																																																																																																																																
Y1																																																																																																																																
Y2																																																																																																																																
Y3																																																																																																																																
Y4																																																																																																																																
Y5																																																																																																																																
Y6																																																																																																																																
Y7																																																																																																																																
●																																																																																																																																
UP1																																																																																																																																
ZP1																																																																																																																																
Y10																																																																																																																																
Y11																																																																																																																																
Y12																																																																																																																																
Y13																																																																																																																																
●																																																																																																																																

註：本機種輸出端子配置與 DVP-SS 系列不同，使用時請注意配線之變更。

## ■ 安裝方式

PLC 在安裝時，請裝配於封閉式之控制箱內，其周圍應保持一定之空間，以確保 PLC 散熱功能正常，請參閱英文版[Figure 3]。

- 直接鎖螺絲方式：請依產品外型尺寸並使用 M4 螺絲。
- DIN 鋁軌之安裝方法：適用於 35mm 之 DIN 鋁軌。在將主機掛上鋁軌時，請先將主機（或 I/O 模組）下方之固定塑膠片，以一字形起子插入凹槽並向外撐開拉出，再將主機（或 I/O 模組）掛上鋁軌，之後將固定塑膠片壓扣回去即可。欲取下主機時，同樣以一字形起子先將固定塑膠片撐開，再將主機以往外向上的方式取出即可。該固定機構塑膠片為保持型，因此撐開後便不會彈回去。

## ■ 配線端子

1. 輸出/入配線端請使用 22-16AWG (1.5mm) 單蕊裸線或多蕊線，端子規格如圖示。PLC 端子螺絲扭力為 1.90 kg-cm (1.65 in-lbs)。只能使用 60/75°C 的銅導線。
2. 空端子請勿配線。輸入點信號線與輸出點等動力線請勿置於同一線槽內。
3. 鎖螺絲及配線時請避免微小的金屬導體掉入 PLC 內部，並在配線完成後保持散熱空間。

### ◆ 電源端

DVP-SS2 機種為直流電源輸入，在使用上應注意下列事項：

1. 電源請接於 24VDC 及 0V 兩端，電源範圍為 20.4 ~ 28.8VDC，當電源電壓低於 20.4VDC 時，PLC 會停止運轉，輸出全部 Off，ERROR LED 快速閃爍。
2. 當停電時間低於 10ms 時，PLC 不受影響繼續運轉，當停電時間過長或電源電壓下降將使 PLC 停止運轉，輸出全部 Off，當電源恢復正常時，PLC 亦自動回復運轉。（PLC 內部具停電保持的輔助繼電器及暫存器，使用者在規劃程式設計時應特別注意使用。）

## ◆ 安全配線回路

由於 DVP-SS2 的電源為 DC Only 的機種，因此可搭配台達之電源供應模組 (DVPPS01/DVPPS02) 提供電源給 DVP-SS2。為保護 DVPPS01/DVPPS02，建議可在電源的輸入回路端配置如下的保護回路，配置圖請參閱英文版[Figure 4]所示：

① 交流電源供應：100 ~ 240VAC, 50/60Hz	② 斷路器
③ 緊急停止：為預防突發狀況發生，設置緊急停止按鈕，可在狀況發生時，切斷系統電源。	
④ 電源指示燈	⑤ 交流電源負載
⑥ 電源回路保護用保險絲 (2A)	⑦ DVPPS01/DVPPS02 本體
⑧ 直流電源供應輸出：24VDC，500mA	⑨ DVP PLC 本體
⑩ 數位輸入/輸出模組	

## ◆ 輸入點之配線

輸入點之人力信號為直流電源 DC 輸入型式，共有兩種接法：SINK 及 SOURCE，其定義與輸入點回路等效電路配線圖，請參閱英文版[Figure 5]及[Figure 6]。

## ◆ 輸出點之配線

1. DVP-SS2 系列 PLC 輸出模組共有二種：繼電器與電晶體。輸出端在實際配線時，應特別注意共用端的連接。
2. 繼電器機種輸出端 Y0、Y1、Y2 用 C0 共同端，Y3、Y4、Y5 用 C1 共同端，請參閱英文版[Figure 7]。動作指示：當輸出點動作時，正面的該點指示燈亮。
3. 電晶體 (NPN) 機種輸出端 Y0 ~Y5, Y0~Y13 用 UP、ZP 共同端，請參閱英文版[Figure 8a]。電晶體 (PNP) 機種輸出端 Y0 ~Y3, Y0~Y13 用 UP、ZP 共同端，請參閱英文版[Figure 8b]。
4. 隔離回路：PLC 內部回路與輸入模組之間使用光耦合器作信號隔離。

## ● 繼電器輸出回路配線

詳細配線圖請參閱英文版[Figure 9] ~ [Figure 11]。

① 直流電源供給	② 緊急停止：使用外部開關
③ 保險絲：使用 5 ~ 10A 的保險絲容量於輸出接點的共用點，保護輸出點回路	
④ 突波吸收二極體：可增加接點壽命。 1. DC 負載電源之二極體抑制：功率較小時使用 (請參閱英文版[Figure 10a]) 2. DC 負載電源之二極體+Zener 抑制：大功率且 On/Off 頻繁時使用 (請參閱英文版[Figure 10b])	
⑤ 白熾燈 (電阻性負載)	⑥ 交流電源供給
⑦ 互斥輸出：例如，將 Y3 與 Y4 用以控制對應馬達的正轉及反轉，使外部電路形成互鎖，配合 PLC 內部程式，確保任何異常突發狀況發生時，均有安全的保護措施。	
⑧ 突波吸收器：可減少交流負載上的雜訊 (請參閱英文版[Figure 11])	

## ● 電晶體輸出回路配線

詳細配線圖請參閱英文版[Figure 12] ~ [Figure 15b]。

- |          |        |              |
|----------|--------|--------------|
| ① 直流電源供應 | ② 緊急停止 | ③ 電路回路保護用保險絲 |
|----------|--------|--------------|
- ④ 突波吸收二極體：可增加接點壽命。
- DC 負載電源之二極體抑制：功率較小時使用（請參閱英文版[Figure 14a]及[Figure 15a]）
  - DC 負載電源之二極體+Zener 抑制：大功率且 On/Off 頻繁時使用（請參閱英文版[Figure 14b]及[Figure 15b]）
- ⑤ 互斥輸出：例如，將 Y2 與 Y3 用以控制對應馬達的正轉及反轉，使外部電路形成互鎖，配合 PLC 內部程式，確保任何異常突發狀況發生時，均有安全的保護措施。

## ● PWM DA 輸出回路配線（僅適用於 DVP12SS211S 機種）

詳細接線圖請參閱下圖圖一所示。

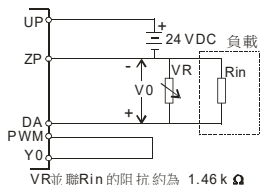

【圖一】

項目	規格
DA 範圍	0~10VDC
數值範圍	0~100
解析度*1	0.1V (1~9V)
輸出阻抗	2kΩ
最小負載	1.5kΩ
D/A 變換時間	<70ms

\*1：1~9V 為線性區，解析度為 0.1V；0~1V 與 9~10V 為非線性區，輸出可能無法到達設定電壓。

使用 PWM DA 輸出功能前，請參考此校正公式：

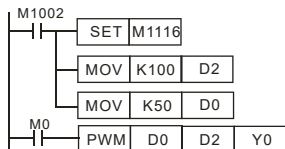

參閱 PWM 指令設定 Y0 脈波輸出時間單位

設定脈波週期為 100μs

設定脈波 duty cycle 為 50%

設定 M0 ON，然後調整可變電阻 VR，使得 V0=5V 即可，如下曲線圖。

## ◆ RS-485 建議接線

詳細接線圖請參閱英文版[Figure 17]。

- |        |
|--------|
| ① 主站   |
| ② 從站   |
| ③ 終端電阻 |

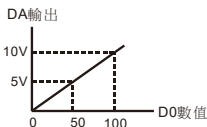

附註：1. 終端電阻建議連接於主站及最後一台從站上，且其電阻值建議為 120Ω。

2. 為確保連線品質，線材建議使用具有雙層遮蔽線之通訊雙絞線(20AWG)。

感谢您采用台达 DVP 系列可编程控制器。DVP-SS2 系列提供 12, 14, 28 点 PLC 主机，并具有丰富的指令集及 8k steps 的程序内存，可连接薄型全系列 I/O 模块，包含数字量输入/输出（最大输入 / 输出扩展点数可达 480 点）、及模拟量模块（A/D、D/A 转换及温度单元）。四组（10kHz）高速脉冲输出可满足各种应用场合，并且体积小，安装容易。全系列採用免電池設計，其 PLC 程式與停電保持資料皆運用高速快閃記憶體儲存。

- ✎ 本安装说明书提供给使用者电气规格、功能规格、安装配线的相关注意事项。其它详细的程序设计及指令说明请见 DVP-SS2 操作手册【程序篇】，选购的周边装置详细说明请见该产品随机安装说明书。
- ✎ 本机为开放型 (OPEN TYPE) 机种，因此使用者使用本机时，必须将的安装于具防尘、防潮及免于电击 / 冲击意外的外壳配线箱内。另必须具备保护措施（如：特殊的工具或钥匙才可打开）防止非维护人员操作或意外冲击本体，造成危险及损坏。
- ✎ 交流输入电源不可连接于输入 / 出信号端，否则可能造成严重损坏，请在上电的前再次确认电源配线。请勿在上电时触摸任何端子。本体上的接地端子 ⊕ 务必正确的接地，可提高产品抗干扰能力。

## ■ 尺寸及产品外观部位介绍

### A. DVP12SS2/14SS2

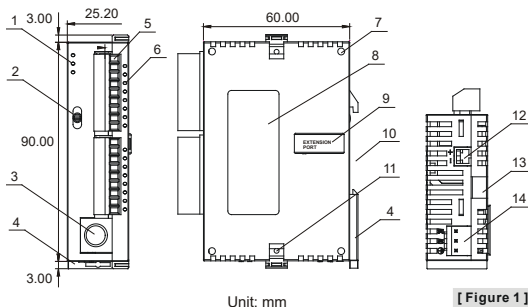

[ Figure 1 ]

1. 电源、运行、错误及状态指示灯	8. 铭牌
2. RUN / STOP 开关	9. I/O 模块连接口
3. COM1 (RS-232) 通讯口	10. DIN 轨槽 (35mm)
4. DIN 轨固定扣	11. I/O 模块固定扣
5. 输入 / 输出端子	12. COM2 (RS-485) 通讯口
6. 输入 / 输出点指示灯	13. I/O 模块固定槽
7. I/O 模块定位孔	14. 电源输入口



## B. DVP28SS2

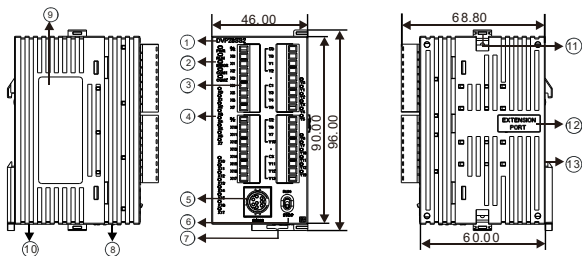

1. 机种名称	8. COM2 (RS-485) 通讯口
2. 电源、运行、错误、COM1、COM2 状态指示灯	9. 标签
3. 输入/输出端子	10. 电源输入口
4. 输入/输出指示灯	11. I/O 模块固定扣
5. COM1 (RS-232) 通讯口	12. I/O 模块连接口
6. RUN/STOP 开关	13. DIN 轨槽 (35mm)
7. DIN 轨固定扣	

## ■ 电气规格

机种 DVP 项目	14SS211R	14SS211T	12SS211S	28SS211R	28SS211T 28SS211S
电源电压	24VDC (-15% ~ 20%) (具直流输入电源极性反接保护) DVPPS01(PS02): 输入 100-240VAC, 输出 24VDC/1A (PS02: 2A)				
突入电流	Max. 7.5A@24VDC				
电源保险丝容量	1.85A/30VDC, 可恢复式 (Polyswitch)				
消耗电力	1.8W	1.5W		3.6W	1.7W
电源保护	具直流输入电源极性反接保护				
工作环境	无腐蚀性气体存在				
安装位置	控制箱内				
污染等级	2				
防护等级	IP20				
突波电压耐受量	1,500VAC (Primary-secondary), 1,500VAC (Primary-PE), 500VAC (Secondary-PE)				
绝缘阻抗	> 5MΩ (所有输出 / 入点对地之间 500VDC)				
干扰免疫力	ESD (IEC 61131-2, IEC 61000-4-2): 8kV Air Discharge EFT (IEC 61131-2, IEC 61000-4-4): Power Line: 2kV, Digital I/O: 1kV, Analog & Communication I/O: 1kV RS (IEC 61131-2, IEC 61000-4-3): 26MHz ~ 1GHz, 10V/m				
接地	接地配线的线径不得小于电源端配线线径 (多台 PLC 同时使用时, 请务必单点接地)				
操作 / 储存环境	操作: 0°C ~ 55°C (温度) 5 ~ 95% (湿度), 无结露 储存: -25°C ~ 70°C (温度) 5 ~ 95% (湿度), 无结露				
耐振动 / 冲击	国际标准规范 IEC61131-2, IEC 68-2-6 (TEST Fc)/IEC61131-2 & IEC 68-2-27 (TEST Ea)				

机种 DVP 项目	14SS211R	14SS211T	12SS211S	28SS211R	28SS211T 28SS211S
适用大气压	操作: 1080 ~ 795hPa (相当于海拔 -1000 ~ 2000 公尺) 储存: 1080 ~ 660hPa (相当于海拔 -1000 ~ 3500 公尺)				
重量	97g	82.5g	90g	177g	155g(T)/ 151g(S)

项目	机种	输入点电气规格		
		12SS2, 14SS2, 28SS2		28SS2
输入点 No.		X0 ~ X3	X4 ~ X7	X10 ~ X17
输入接线型式		由端子 S/S 变换接线为漏型或源型		
输入信号电压(±10%)		24VDC (-15% ~ 20%), 5mA		
输入阻抗		4.7k Ohm		
最大输入频率		20kHz	10kHz	1kHz <sup>#3</sup>
动作临界点	Off→On	> 15VDC		
	On→Off	< 5VDC		
反应时间	Off→On	< 10μs	< 20μs	< 200μs
干扰抑制	On→Off	< 20μs	< 50μs	< 200μs
滤波时间		X0 ~ X7 由 D1020 可作 0 ~ 20 ms 的调整 (预设: 10ms) X10 ~ X17 由 D1021 可作 0 ~ 20 ms 的调整 (预设: 10ms)		

项目	型态与规格	输出点电气规格		
		继电器	晶体管 (NPN & PNP)	
输出点 No.		Y0 ~ Y7, Y10~Y13	Y0 ~ Y3	Y4 ~ Y7, Y10~Y13
最高交换频率		1Hz	10kHz	1kHz <sup>#3</sup>
电压规格		250VAC, < 30VDC	5 ~ 30VDC <sup>#1</sup>	
电流规格	电阻性	1.5A/1 点 (5A/COM)	0.5A/1 点 (3A/COM)	
	电感性	#2	15W (30VDC)	
	灯泡	20WDC/100WAC	2.5W (30VDC)	
反应时间	Off→On	约 10 ms	20μs	100μs
	On→Off		30μs	100μs

#1: UP, ZP 必须外加辅助电源 24VDC (-15% ~ +20%) 额定消耗约 10mA/点。

#2: 生命周期曲线图请参阅英文版[Figure 2]。

#3: 此处最高输入/输出频率会受实际 PLC 扫描时间影响。

## ■ 输入/输出配置

14SS211R	14SS211T	12SS211S	28SS211R	28SS211T	28SS211S																																																																																																																															
继电器 8IN/6OUT	晶体管(NPN) 8IN/6OUT	晶体管 (PNP) 8IN/4OUT	继电器 16IN/12OUT	晶体管(NPN/PNP) 16IN/12OUT																																																																																																																																
直流 (Sink or Source)																																																																																																																																				
<table border="1"> <tr><td>S/S</td></tr><tr><td>X0</td></tr><tr><td>X1</td></tr><tr><td>X2</td></tr><tr><td>X3</td></tr><tr><td>X4</td></tr><tr><td>X5</td></tr><tr><td>X6</td></tr><tr><td>X7</td></tr><tr><td>C0</td></tr><tr><td>Y0</td></tr><tr><td>Y1</td></tr><tr><td>Y2</td></tr><tr><td>●</td></tr><tr><td>C1</td></tr><tr><td>Y3</td></tr><tr><td>Y4</td></tr><tr><td>Y5</td></tr></table>	S/S	X0	X1	X2	X3	X4	X5	X6	X7	C0	Y0	Y1	Y2	●	C1	Y3	Y4	Y5	<table border="1"> <tr><td>S/S</td></tr><tr><td>X0</td></tr><tr><td>X1</td></tr><tr><td>X2</td></tr><tr><td>X3</td></tr><tr><td>X4</td></tr><tr><td>X5</td></tr><tr><td>X6</td></tr><tr><td>X7</td></tr><tr><td>UP</td></tr><tr><td>ZP</td></tr><tr><td>●</td></tr><tr><td>Y0</td></tr><tr><td>Y1</td></tr><tr><td>Y2</td></tr><tr><td>Y3</td></tr><tr><td>Y4</td></tr><tr><td>Y5</td></tr></table>	S/S	X0	X1	X2	X3	X4	X5	X6	X7	UP	ZP	●	Y0	Y1	Y2	Y3	Y4	Y5	<table border="1"> <tr><td>S/S</td></tr><tr><td>X0</td></tr><tr><td>X1</td></tr><tr><td>X2</td></tr><tr><td>X3</td></tr><tr><td>X4</td></tr><tr><td>X5</td></tr><tr><td>X6</td></tr><tr><td>X7</td></tr><tr><td>UP</td></tr><tr><td>ZP</td></tr><tr><td>●</td></tr><tr><td>DA</td></tr><tr><td>PWM</td></tr><tr><td>Y0</td></tr><tr><td>Y1</td></tr><tr><td>Y2</td></tr><tr><td>Y3</td></tr></table>	S/S	X0	X1	X2	X3	X4	X5	X6	X7	UP	ZP	●	DA	PWM	Y0	Y1	Y2	Y3	<table border="1"> <tr><td>S/S</td></tr><tr><td>X0</td></tr><tr><td>X1</td></tr><tr><td>X2</td></tr><tr><td>X3</td></tr><tr><td>X4</td></tr><tr><td>X5</td></tr><tr><td>X6</td></tr><tr><td>X7</td></tr><tr><td>S/S</td></tr><tr><td>X10</td></tr><tr><td>X11</td></tr><tr><td>X12</td></tr><tr><td>X13</td></tr><tr><td>X14</td></tr><tr><td>X15</td></tr><tr><td>X16</td></tr><tr><td>X17</td></tr></table>	S/S	X0	X1	X2	X3	X4	X5	X6	X7	S/S	X10	X11	X12	X13	X14	X15	X16	X17	<table border="1"> <tr><td>C0</td></tr><tr><td>Y0</td></tr><tr><td>Y1</td></tr><tr><td>Y2</td></tr><tr><td>●</td></tr><tr><td>C1</td></tr><tr><td>Y3</td></tr><tr><td>Y4</td></tr><tr><td>Y5</td></tr><tr><td>C2</td></tr><tr><td>Y6</td></tr><tr><td>Y7</td></tr><tr><td>Y10</td></tr><tr><td>●</td></tr><tr><td>C3</td></tr><tr><td>Y11</td></tr><tr><td>Y12</td></tr><tr><td>Y13</td></tr></table>	C0	Y0	Y1	Y2	●	C1	Y3	Y4	Y5	C2	Y6	Y7	Y10	●	C3	Y11	Y12	Y13	<table border="1"> <tr><td>S/S</td></tr><tr><td>X0</td></tr><tr><td>X1</td></tr><tr><td>X2</td></tr><tr><td>X3</td></tr><tr><td>X4</td></tr><tr><td>X5</td></tr><tr><td>X6</td></tr><tr><td>X7</td></tr><tr><td>S/S</td></tr><tr><td>X10</td></tr><tr><td>X11</td></tr><tr><td>X12</td></tr><tr><td>X13</td></tr><tr><td>X14</td></tr><tr><td>X15</td></tr><tr><td>X16</td></tr><tr><td>X17</td></tr></table>	S/S	X0	X1	X2	X3	X4	X5	X6	X7	S/S	X10	X11	X12	X13	X14	X15	X16	X17	<table border="1"> <tr><td>UP0</td></tr><tr><td>ZP0</td></tr><tr><td>Y0</td></tr><tr><td>Y1</td></tr><tr><td>Y2</td></tr><tr><td>Y3</td></tr><tr><td>Y4</td></tr><tr><td>Y5</td></tr><tr><td>Y6</td></tr><tr><td>Y7</td></tr><tr><td>●</td></tr><tr><td>UP1</td></tr><tr><td>ZP1</td></tr><tr><td>Y10</td></tr><tr><td>Y11</td></tr><tr><td>Y12</td></tr><tr><td>Y13</td></tr><tr><td>●</td></tr></table>	UP0	ZP0	Y0	Y1	Y2	Y3	Y4	Y5	Y6	Y7	●	UP1	ZP1	Y10	Y11	Y12	Y13	●
S/S																																																																																																																																				
X0																																																																																																																																				
X1																																																																																																																																				
X2																																																																																																																																				
X3																																																																																																																																				
X4																																																																																																																																				
X5																																																																																																																																				
X6																																																																																																																																				
X7																																																																																																																																				
C0																																																																																																																																				
Y0																																																																																																																																				
Y1																																																																																																																																				
Y2																																																																																																																																				
●																																																																																																																																				
C1																																																																																																																																				
Y3																																																																																																																																				
Y4																																																																																																																																				
Y5																																																																																																																																				
S/S																																																																																																																																				
X0																																																																																																																																				
X1																																																																																																																																				
X2																																																																																																																																				
X3																																																																																																																																				
X4																																																																																																																																				
X5																																																																																																																																				
X6																																																																																																																																				
X7																																																																																																																																				
UP																																																																																																																																				
ZP																																																																																																																																				
●																																																																																																																																				
Y0																																																																																																																																				
Y1																																																																																																																																				
Y2																																																																																																																																				
Y3																																																																																																																																				
Y4																																																																																																																																				
Y5																																																																																																																																				
S/S																																																																																																																																				
X0																																																																																																																																				
X1																																																																																																																																				
X2																																																																																																																																				
X3																																																																																																																																				
X4																																																																																																																																				
X5																																																																																																																																				
X6																																																																																																																																				
X7																																																																																																																																				
UP																																																																																																																																				
ZP																																																																																																																																				
●																																																																																																																																				
DA																																																																																																																																				
PWM																																																																																																																																				
Y0																																																																																																																																				
Y1																																																																																																																																				
Y2																																																																																																																																				
Y3																																																																																																																																				
S/S																																																																																																																																				
X0																																																																																																																																				
X1																																																																																																																																				
X2																																																																																																																																				
X3																																																																																																																																				
X4																																																																																																																																				
X5																																																																																																																																				
X6																																																																																																																																				
X7																																																																																																																																				
S/S																																																																																																																																				
X10																																																																																																																																				
X11																																																																																																																																				
X12																																																																																																																																				
X13																																																																																																																																				
X14																																																																																																																																				
X15																																																																																																																																				
X16																																																																																																																																				
X17																																																																																																																																				
C0																																																																																																																																				
Y0																																																																																																																																				
Y1																																																																																																																																				
Y2																																																																																																																																				
●																																																																																																																																				
C1																																																																																																																																				
Y3																																																																																																																																				
Y4																																																																																																																																				
Y5																																																																																																																																				
C2																																																																																																																																				
Y6																																																																																																																																				
Y7																																																																																																																																				
Y10																																																																																																																																				
●																																																																																																																																				
C3																																																																																																																																				
Y11																																																																																																																																				
Y12																																																																																																																																				
Y13																																																																																																																																				
S/S																																																																																																																																				
X0																																																																																																																																				
X1																																																																																																																																				
X2																																																																																																																																				
X3																																																																																																																																				
X4																																																																																																																																				
X5																																																																																																																																				
X6																																																																																																																																				
X7																																																																																																																																				
S/S																																																																																																																																				
X10																																																																																																																																				
X11																																																																																																																																				
X12																																																																																																																																				
X13																																																																																																																																				
X14																																																																																																																																				
X15																																																																																																																																				
X16																																																																																																																																				
X17																																																																																																																																				
UP0																																																																																																																																				
ZP0																																																																																																																																				
Y0																																																																																																																																				
Y1																																																																																																																																				
Y2																																																																																																																																				
Y3																																																																																																																																				
Y4																																																																																																																																				
Y5																																																																																																																																				
Y6																																																																																																																																				
Y7																																																																																																																																				
●																																																																																																																																				
UP1																																																																																																																																				
ZP1																																																																																																																																				
Y10																																																																																																																																				
Y11																																																																																																																																				
Y12																																																																																																																																				
Y13																																																																																																																																				
●																																																																																																																																				

**注：本机种输出端子配置与 DVP-SS 系列不同，使用时请注意配线之变更。**

## ■ 安装方式

PLC 在安装时，请装配于封闭式的控制箱内，其周围应保持一定的空间，以确保 PLC 散热功能正常，请参阅英文版[Figure 3]。

- 直接锁螺丝方式：请依产品外型尺寸并使用 M4 螺丝。
- DIN 铝轨的安装方法：适用于 35mm 的 DIN 铝轨。在将主机挂上铝轨时，请先将主机（或 I/O 模块）下方的固定塑料片，以一字形起子插入凹槽并向外撑开拉出，再将主机（或 I/O 模块）挂上铝轨，之后将固定塑料片压扣回去即可。欲取下主机时，同样以一字形起子先将固定塑料片撑开，再将主机以往外向上的方式取出即可。该固定机构塑料片为保持型，因此撑开后便不会弹回去。

## ■ 配线端子

1. 输出/入配线端请使用 22-16AWG (1.5mm) 单蕊裸线或多蕊线，端子规格如页码 3 之图示。PLC 端子螺丝扭力为 1.90 kg-cm (1.65 in-lbs)。只能使用 60/75°C 的铜导线。
2. 空端子请勿配线。输入点信号线与输出点等动力线请勿置于同一线槽内。
3. 锁螺丝及配线时请避免微小的金属导体掉入 PLC 内部，并在配线完成后保持散热空间。

## ◆ 电源端

DVP-SS2 机种为直流电源输入，在使用上应注意下列事项：

1. 电源请接于 24VDC 及 0V 两端，电源范围为 20.4VDC ~ 28.8VDC，当电源电压低于 20.4VDC 时，PLC 会停止运行，输出全部 Off，ERROR LED 快速闪烁。
2. 当停电时间低于 10ms 时，PLC 不受影响继续运转，当停电时间过长或电源电压下降将使 PLC 停止运转，输出全部 Off，当电源恢复正常时，PLC 亦自动回复运转。（PLC 内部具停电保持的辅助继电器及寄存器，使用者在规划程序设计时应特别注意使用。）

## ◆ 安全配线回路

由于 DVP-SS2 的电源为 DC Only 的机种，因此可搭配台达的电源供应模块 (DVPPS01/DVPPS02) 提供电源给 DVP-SS2。为保护 DVPPS01/DVPPS02，建议在电源的输入回路端配置如下的保护回路，配置图请参阅英文版[Figure 4]所示：

① 交流供应电源：100 ~ 240VAC, 50/60Hz	② 断路器
③ 紧急停止：为预防突发状况发生，设置紧急停止按钮，可在状况发生时，切断系统电源。	
④ 电源指示灯	⑤ 交流电源负载
⑥ 电源回路保护用保险丝（2A）	⑦ DVPPS01/DVPPS02 本体
⑧ 直流供应电源输出：24VDC, 500mA	⑨ DVP PLC 本体
⑩ 数字量输入/输出模块	

## ◆ 输入点的配线

输入点的接入信号为直流电源 DC 输入，DC 型式共有两种接法：漏型及源型，其定义与输入点回路等效电路配线图，请参阅英文版[Figure 5]及[Figure 6]。

## ◆ 输出点的配线

1. DVP-SS2 系列 PLC 输出模块共有三种：继电器、晶体管-NPN 与晶体管-PNP。输出端在实际配线时，应特别注意共享端的连接。
2. 继电器机种输出端 Y0、Y1、Y2 用 C0 共同端，Y3、Y4、Y5 用 C1 共同端，请参阅英文版[Figure 7]。动作指示：当输出点动作时，正面的该点指示灯亮。
3. 晶体管(NPN)机种输出端 Y0~Y5, Y0~Y13 共享 UP、ZP 共同端，请参阅英文版[Figure 8a]。晶体管(PNP)机种输出端 Y0 ~Y3, Y0~Y13 用 UP、ZP 共同端，请参阅英文版[Figure 8b]。
4. 隔离回路：PLC 内部回路与输入模块之间使用光耦合器作信号隔离。

## ● 继电器输出回路配线

详细配线图请参阅英文版[Figure 9] ~ [Figure 11]。

① 直流电源供给	② 紧急停止：使用外部开关
③ 保险丝：于输出接点的公共端使用容量 5 ~ 10A 的保险丝，保护输出点回路	
④ 突波吸收二极管：可增加接点寿命。 <ol style="list-style-type: none"><li>1. DC 负载电源的二极管抑制：功率较小时使用（请参阅英文版[Figure 10a]）</li><li>2. DC 负载电源的二极管+Zener 抑制：大功率及 On/Off 频繁时使用（请参阅英文版[Figure 10b]）。</li></ol>	
⑤ 白炽灯（电阻性负载）	⑥ 交流电源供给
⑦ 互斥输出：例如，将 Y3 与 Y4 用于控制对应马达的正转及反转，使外部电路形成互锁，配合 PLC 内部程序，确保任何异常突发状况发生时，均有安全的保护措施。	
⑧ 突波吸收器：可减少交流负载上的干扰（请参阅英文版[Figure 11]）	

## ● 晶体管输出回路配线

详细配线图请参阅英文版[Figure 12] ~ [Figure 15b]。

- |          |        |              |
|----------|--------|--------------|
| ① 直流供应电源 | ② 紧急停止 | ③ 电路回路保护用保险丝 |
|----------|--------|--------------|
- ④ 突波吸收二极管：可增加接点寿命。
- DC 负载电源之二极管抑制：功率较小时使用（请参阅英文版[Figure 14a]及[Figure 15a]）
  - DC 负载电源之二极管+Zener 抑制：大功率且 On/Off 频繁时使用（请参阅英文版[Figure 14b]及[Figure 15b]）
- ⑤ 互斥输出：例如，将 Y2 与 Y3 用以控制对应马达的正转及反转，使外部电路形成互锁，配合 PLC 内部程序，确保任何异常突发状况发生时，均有安全的保护措施。

## ● PWM DA 输出回路配线（仅适用于 DVP12SS211S 机种）

详细接线图请参阅下图图一所示。

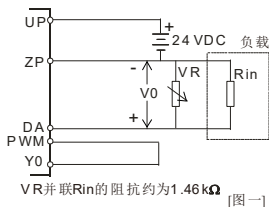

項目	規格
DA 范围	0~10VDC
数值范围	0~100
分辨率*1	0.1V (1~9V)
输出阻抗	2kΩ
最小负载	1.5kΩ
D/A 变换时间	<70ms

\*1: 1~9V 为线性区，分辨率为 0.1V；0~1V 与 9~10V 为非线性区，输出可能无法到达设定电压。

使用 PWM DA 输出功能前，请参考此校正公式：

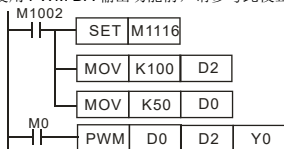

参阅 PWM 指令设定 Y0 脉冲输出时间单位

设定脉冲周期为 100μs

设定脉冲 duty cycle 为 50%

设定 M0 ON，然后调整可变电阻 VR，使得 V0=5V 即可，如下曲线图。

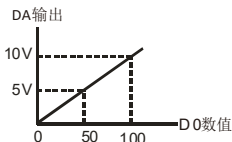

## ◆ RS-485 建议接线

详细接线图请参阅英文版[Figure 17]。

- |        |
|--------|
| ① 主站   |
| ② 从站   |
| ③ 终端电阻 |

附注：1. 终端电阻建议连接于主站及最后一台从站上，且其阻值建议为 120Ω。

2. 为确保联机质量，线材建议使用具有双层屏蔽线的通讯双绞线(20AWG)。