

IN-SIGHT 3D-L4000 3D VISION SYSTEM

All-in-one solution solves 3D inspection applications as easily as 2D vision

The In-Sight® 3D-L4000 is a breakthrough in three-dimensional (3D) vision technology. This unique vision system combines 3D laser displacement technology with a smart camera allowing factory engineers to quickly, accurately, and cost effectively solve a wide variety of inspections on an automated production line. The patented speckle-free blue laser optics, an industry first, acquires high quality 3D images and on-board high-performance processing powers a comprehensive set of true 3D vision tools, without the need for external processing. 3D vision tools are set up as easily as 2D vision tools thanks to the familiar and robust In-Sight spreadsheet environment.



Features

- High performance 2K resolution 3D smart camera
- Speckle-free blue laser optics
- Broad suite of true 3D vision tools
- In-Sight spreadsheet-based setup

Better image formation in real-world settings

The 3D-L4000 series' patented, speckle-free blue laser optical system enables the vision system to capture higher quality images than traditional laser displacement sensors. This type of laser optics minimizes speckle and glare, common problems for 3D laser systems.

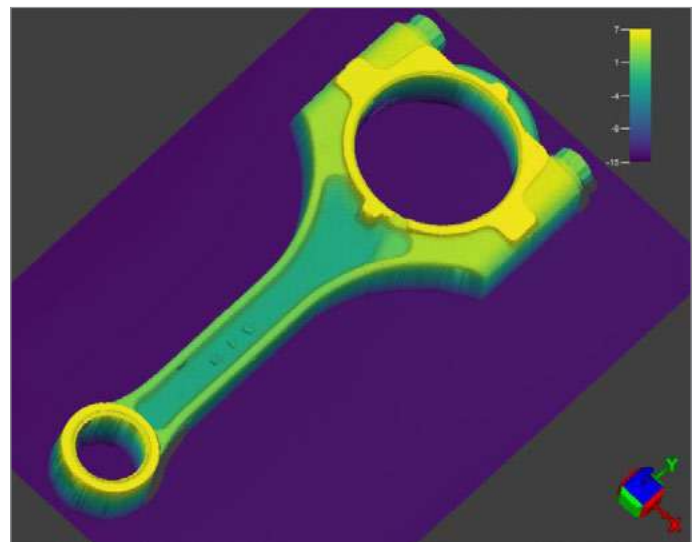
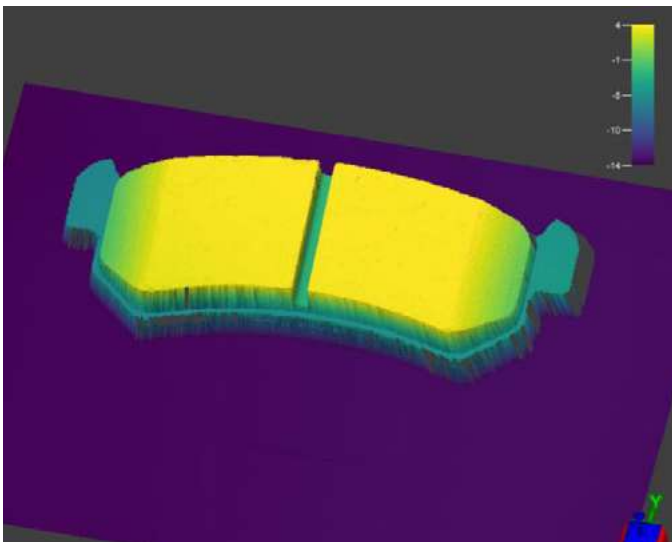

A robust collection of vision tools

The In-Sight 3D-L4000 allows users to place vision tools directly on a true 3D image of the part, unlike typical 3D systems which transform its 3D images into a representational 2D height map for basic tool processing. True 3D inspections increase their accuracy and expands the types of inspections that can be performed. Better yet, because inspections are in 3D, users can immediately experience how the vision tools operate on the actual part or component.

The 3D-L4000 includes all the traditional 3D measurement tools users expect, such as plane and height finding. However, it also comes with a full set of 3D vision tools, designed from the ground up to leverage inspections in a true 3D space. Further, these vision tools were based on the concepts of 2D vision tools, making them accessible to anyone.

PatMax3D

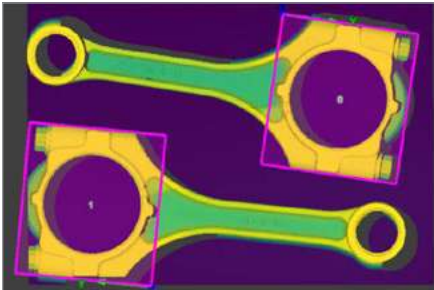

PatMax3D evolves the standard for finding parts. It ensures all vision tools are in the right location to accurately inspect the part on a 3D image.

Blob3D

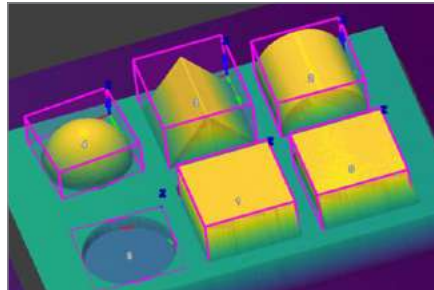

Blob3D finds and measures volumes of features on a 3D image.

Edge3D

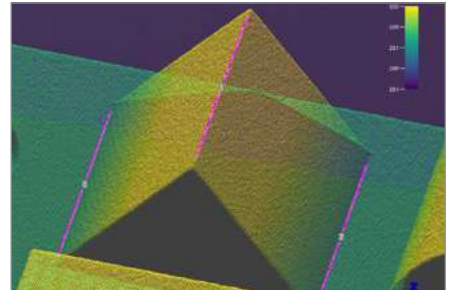

Edge3D uses the geometry of the part to reliably locate convex and concave edges on the 3D image.

Point to Plane3D

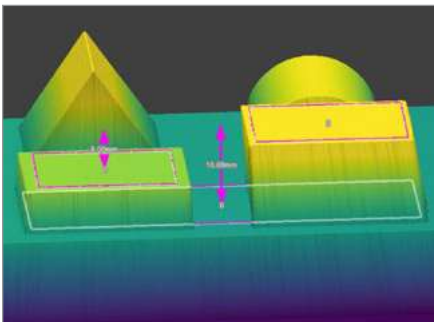

Gap Measurement

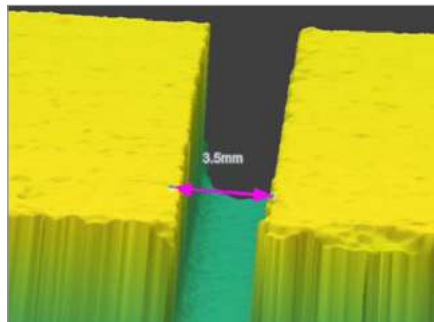

Plane to Plane Angle3D

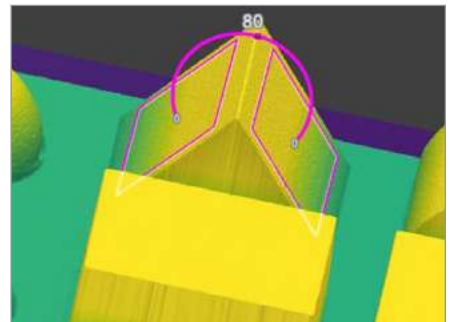

Extract Sphere3D

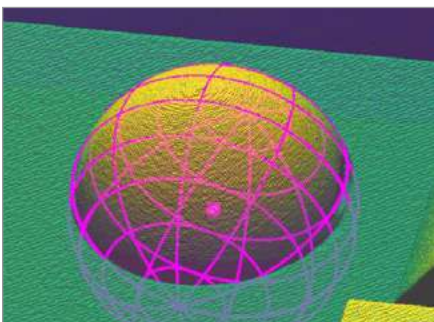

Extract Cylinder3D

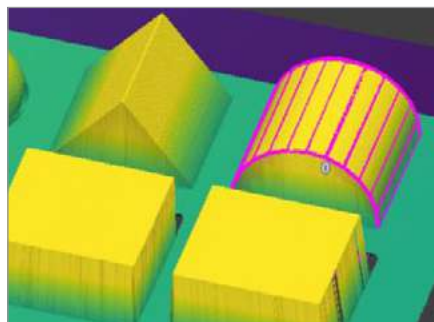

3D Geometry

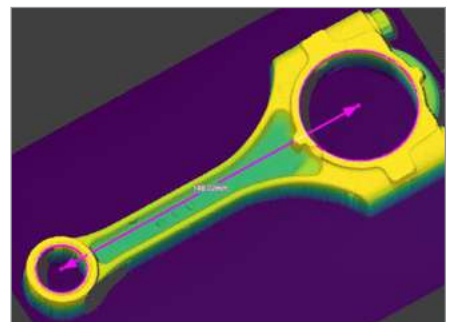

In-Sight spreadsheet guides easy application development

The intuitive In-Sight spreadsheet interface quickly and easily sets up and runs 3D applications without the need for programming. It simplifies application development and streamlines factory integration with a full I/O and communications function set. It also enables the ability to combine 2D and 3D vision tools in the same application, leading to quicker deployments.

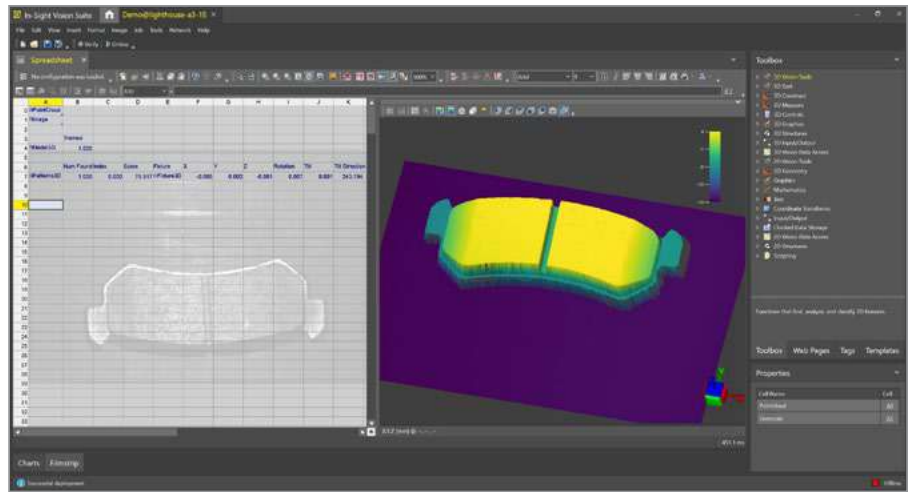

In-Sight 3D-L4000 features

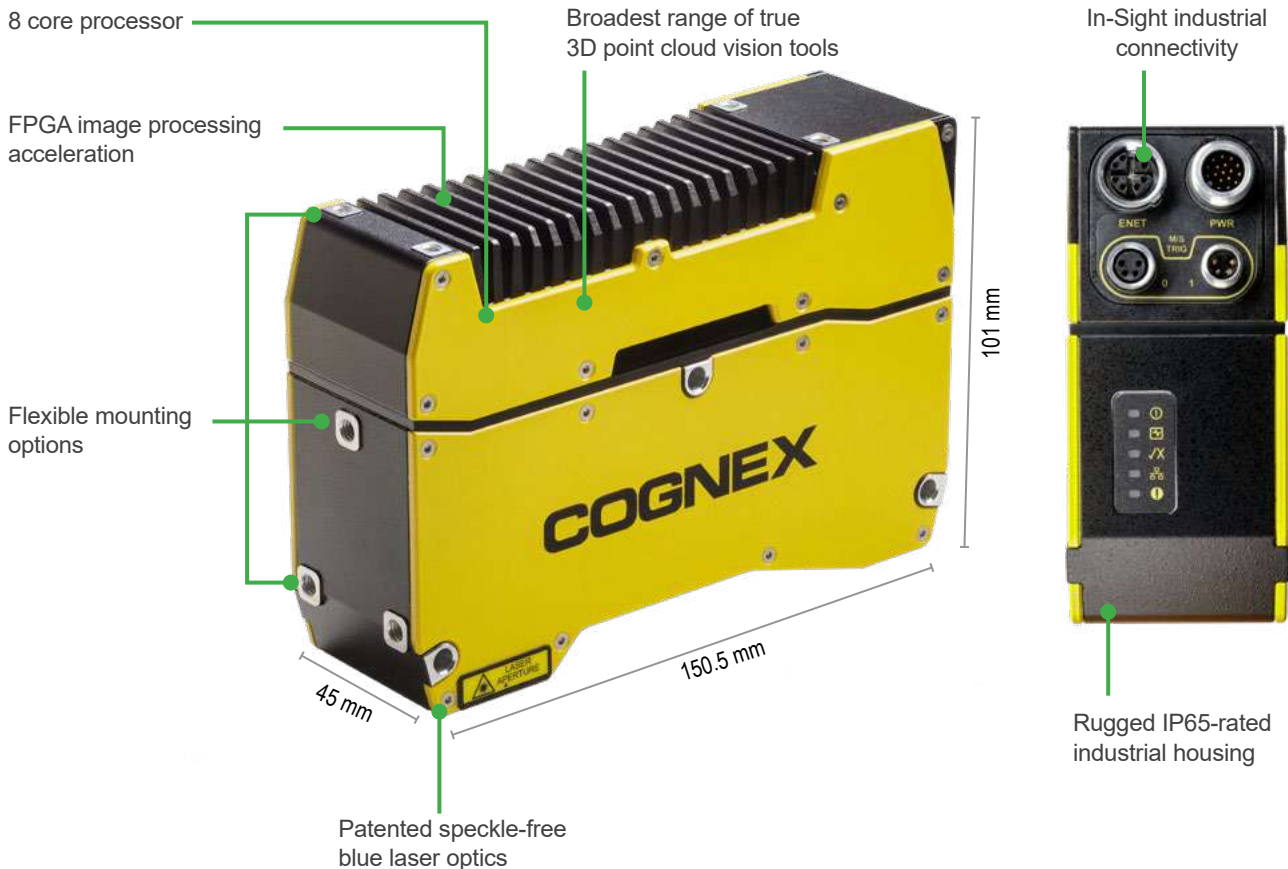

Automotive applications

Brake pad inspection

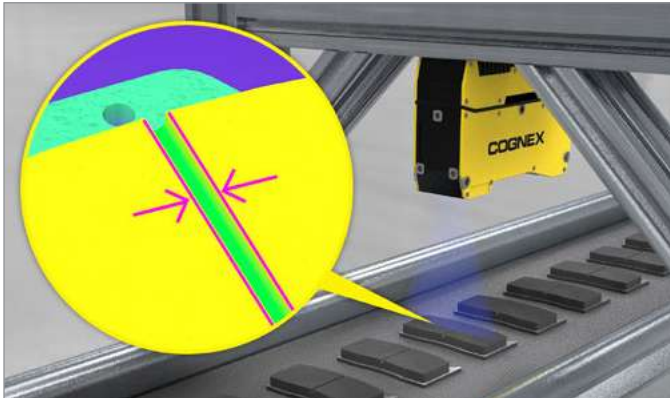

Inspect the gap width for the brake pad. Can also inspect the angle of the beveled edges.

Connecting rod inspection and location

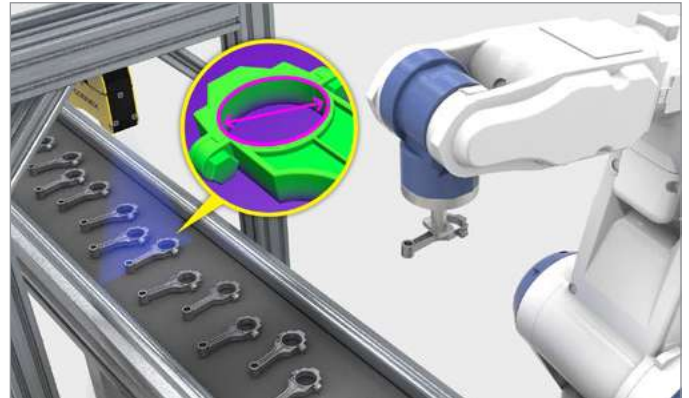

Locate the connecting rod on the belt using PatMax3D and measure the dimensions to ensure there are no part defects.

Glue bead inspection

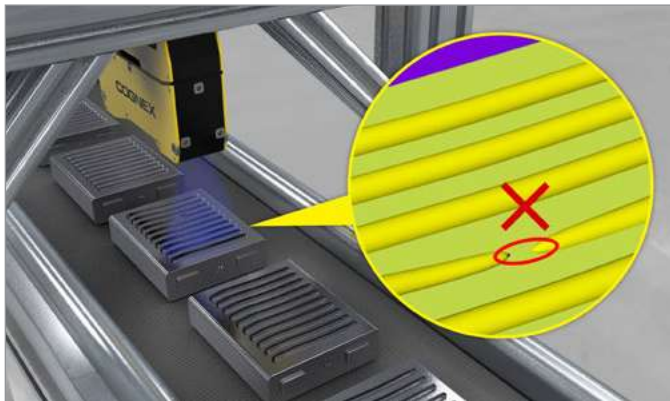

Determine the height, width, volume, and continuity of glue beads.

EV battery inspection

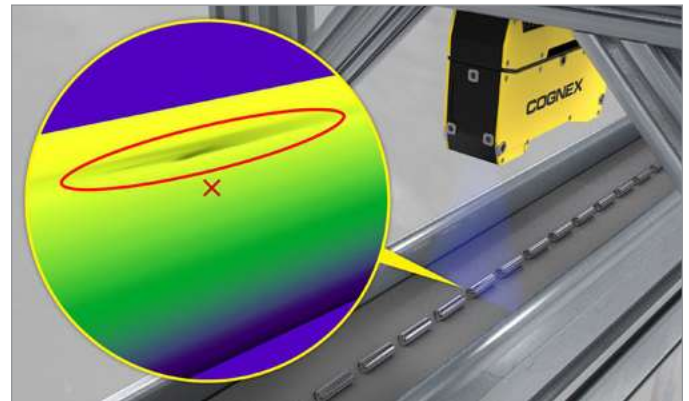

Detect dents, scratches, and other potential defects on the surface of an EV battery.

Extruded rubber splice detection

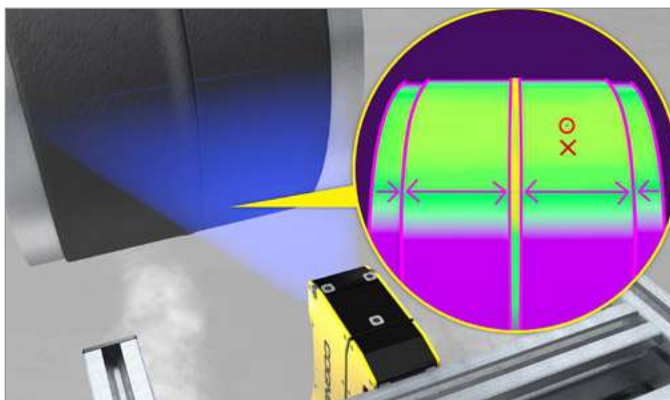

Locate the splice edge and verify the edge is straight on spliced rubber for tires.

Flush and gap inspection

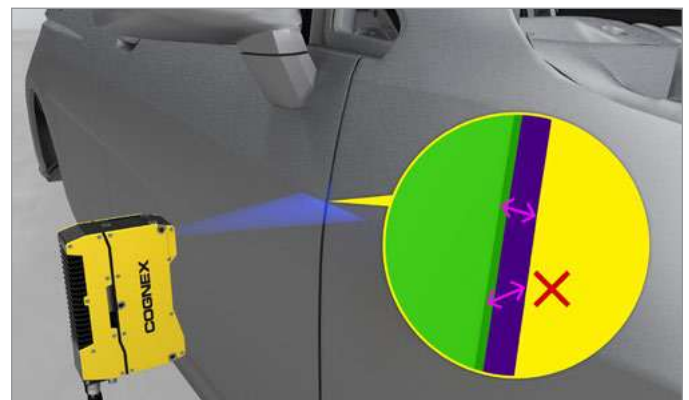

Detect the proper alignment between the door and car body, while ensuring the gap between the two is consistent.

Consumer product applications

Cap inspection

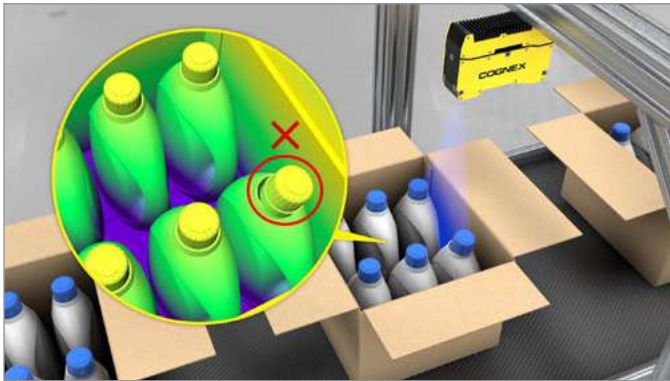

Verify the presence and position of the cap by checking the height and tilt to determine if it is screwed on correctly.

Fill level inspection

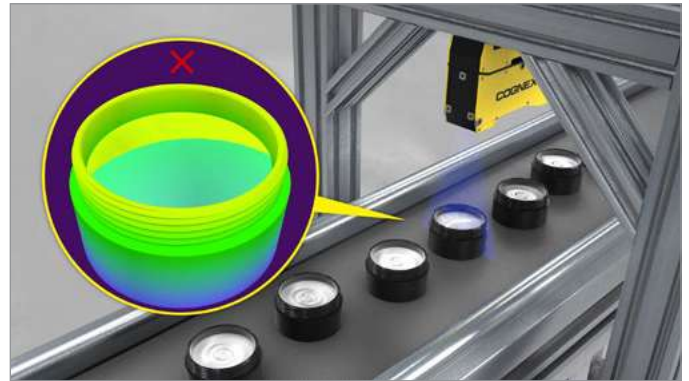

Inspect the height and volume of the contents to ensure that the correct amount of product is in each container.

Flooring inspection

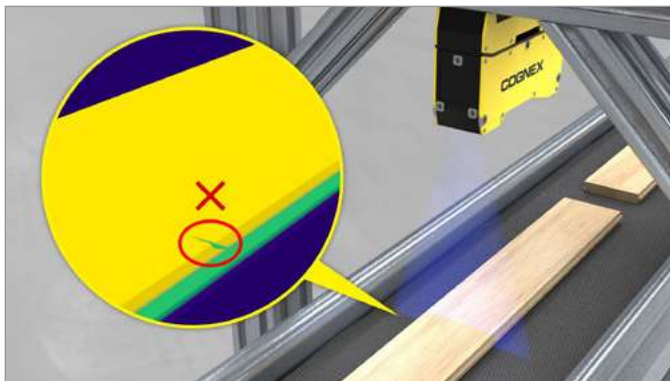

Inspect floor boards for orientation using the tongue. Check for defects along the surface including gouges, bowing, splits, and knotholes.

Packaging quality inspection

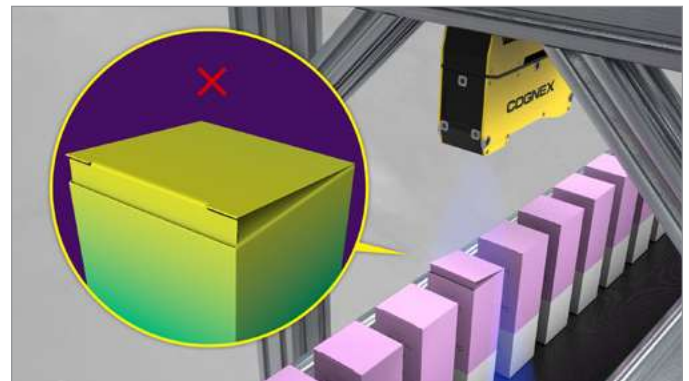

Verify the box is intact and sealed while inspecting for potential quality issues such as crushed corners, tears, or open flaps.

Electronics applications

Connector pin height inspection

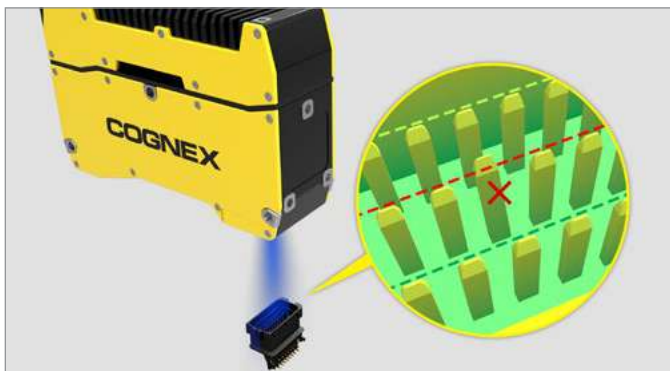

Verify the correct number of pins on the connector and ensure the pins are in the correct position while being free from damage or tilted.

Carrier flatness inspection

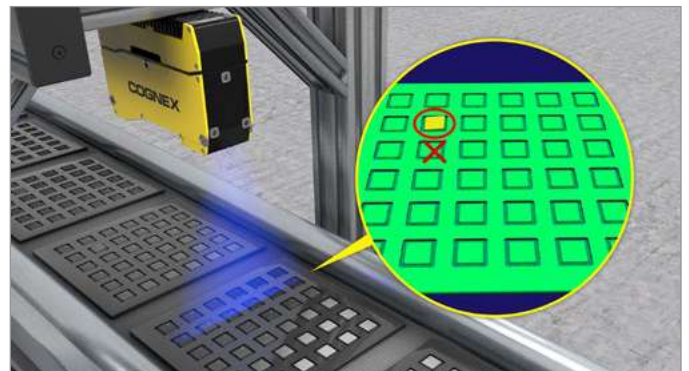

Determine if chips are correctly seated inside the carrier by measuring position and flatness.

Food and beverage applications

Package inspection



Determine the presence or absence of the part in packaging. Then, verify the volume of the package ensuring the correct amount.

Cookie defect detection

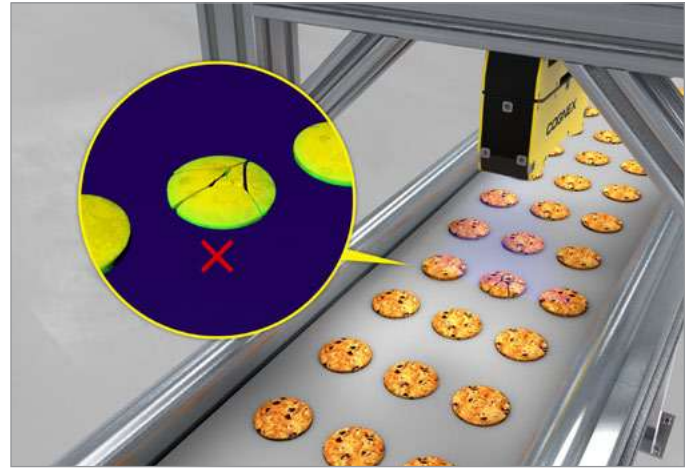

Verify the uniformity of cookies by measuring the length, width, and height. Plus, inspect for defects such as breaks or cracks in the cookies.

Item location

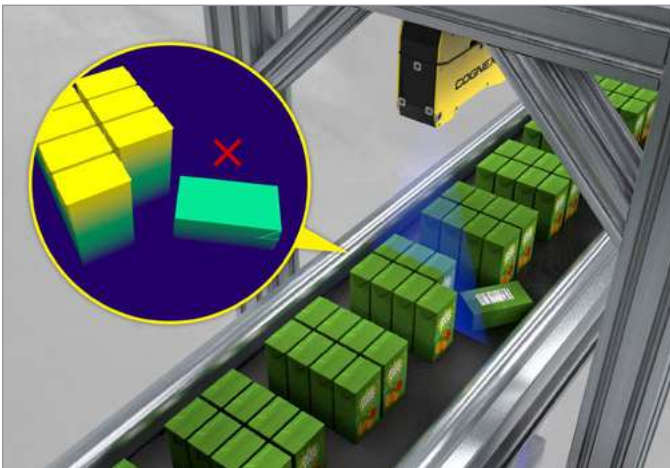

Inspect packages to determine correct number and proper orientation, including they have not fallen down. Also, check for defects in the packaging such as dents or tears.

Cap inspection



Ensure the bottle is properly sealed by checking the height and tilt angle of the bottle cap.

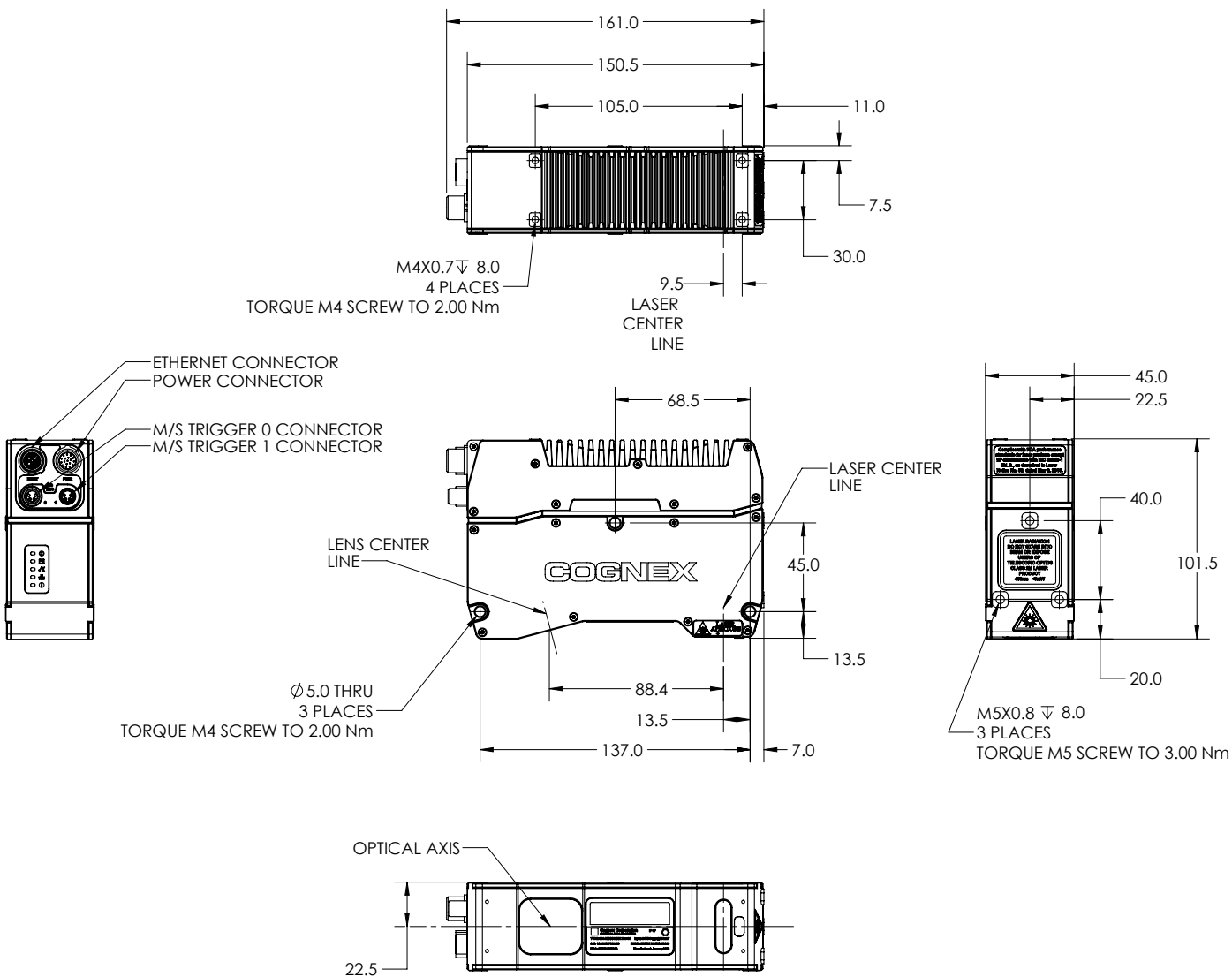

In-Sight 3D-L4000 working distance

WORKING DISTANCE			
	IS3D-L4050	IS3D-L4100	IS3D-L4300
Clearance distance (CD)	92 mm	130 mm	180 mm
Near field of view	55 mm	75 mm	95 mm
Far field of view	90 mm	180 mm	460 mm
Measurement range (MR)	106 mm	235 mm	745 mm

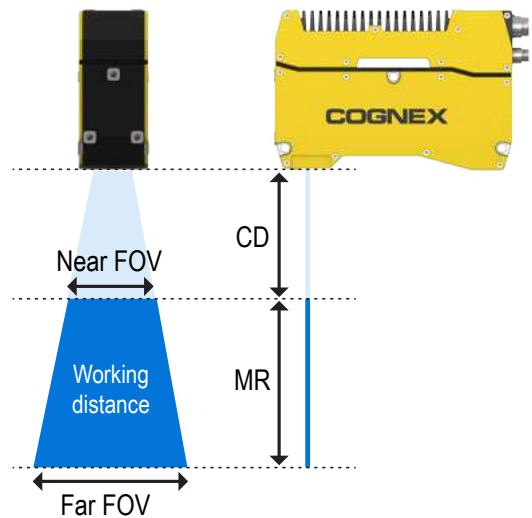

SPECIFICATIONS

		IS3D-L4050		IS3D-L4100		IS3D-L4300		
		1K	2K	1K	2K	1K	2K	
Measurement range	Clearance distance	92.00 mm		130.00 mm		180.00 mm		
	Z-axis (height)	Measurement range	106.00 mm		235.00 mm		745.00 mm	
		Near field of view	55.00 mm		75.00 mm		95.00 mm	
	X-axis (width)	Middle field of view	72.50 mm		127.50 mm		277.50 mm	
Far field of view		90.00 mm		180.00 mm		460.00 mm		
Laser (light source)	Wavelength	450 nm						
	Laser class	2M						
	Output power	45 mW						
Spot size (middle field of view)		110 µm		181 µm		240 µm		
Sensor	Data points/profile	960 points	1920 points	960 points	1920 points	960 points	1920 points	
	X resolution	Top	57.3 µm	28.6 µm	78.1 µm	39.1 µm	99.0 µm	49.5 µm
		Bottom	93.8 µm	46.9 µm	187.5 µm	93.8 µm	479.2 µm	239.6 µm
	Z resolution	Top	2.5 µm		4.4 µm		6.9 µm	
		Bottom	6.9 µm		25.9 µm		147.5 µm	
	Z repeatability ¹	Top	0.5 µm		1 µm		2 µm	
		Bottom	0.5 µm		1 µm		2 µm	
	Z linearity ²	0.06% of full scale (F.S.)		0.04% of full scale (F.S.)		0.05% of full scale (F.S.)		
Temperature characteristics	0.01% of F.S./°C							
Environmental resistance	Housing protection	IP65						
	Operation temperature ³	0–45 °C (32–113 °F)						
	Storage temperature	-20–70 °C (-4–158 °F)						
	Maximum humidity	20 to 80% (no condensation)						
	Vibration	10 to 57, double amplitude 1.5 mm X,Y,Z, 3 hours in each direction						
	Shock	15/6 msec						
Scan rate	Up to 4 kHz (after windowing down the sensor) (*Up to 6 kHz)							
Housing material	Aluminum							
Weight	0.94 kg							
Dimensions	150.5 mm x 101 mm x 45 mm							
Power supply requirements	24 VDC +/- 10%, 750 mA minimum							
Inputs	Trigger, differential/single ended encoder, laser interlock							
Trigger	Input voltage limits: Trig+ - Trig - = -24 VDC to +24 VDC Input ON: >10 VDC (>6 mA) Input OFF: <2 VDC (<1.5 mA)							
Encoder specifications	Differential: A+/B+: 5–24V (1.0 MHz max) A-/B-: Inverted (A+/B+) Single ended: A+/B+: 12–24V (1.0 MHz max) A-/B-: VDC = ½ (A+/B+)							
Interface	Gigabit Ethernet interface Integrated link and traffic LEDs Standard M12-8 X-coded female connector							

¹ Z repeatability is measured an average of 100 times over a pointcloud using a 4x4 mm area, at the middle of the measurement range.

² Z linearity is the maximum deviation of 250 position measurements on the measurement range, where a measurement is the average of 2 profiles using the standard Cognex target.

³ Mounted to a 400 mm aluminum bar on top of the camera.

⁴ When binning is enabled and the FOV is windowed down.



Companies around the world rely on Cognex vision and barcode reading solutions to optimize quality, drive down costs and control traceability.

Corporate Headquarters One Vision Drive Natick, MA 01760 USA | For Regional Sales Offices, visit www.cognex.com/sales

www.cognex.com