

EX-Z SERIES

Related Information

- General terms and conditions..... F-3
- Selection guide P.231~
- Glossary of terms..... P.1549~
- General precautions..... P.1552~

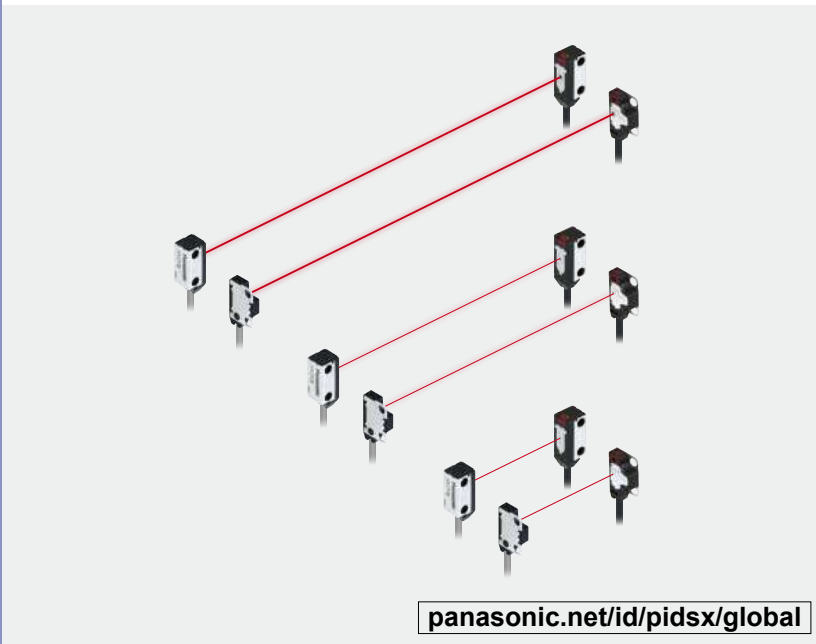

PNP output type available



The World's No. 1* in Compactness * Among photoelectric sensors with built-in amplifier, as of April 2017 in-company survey

Unit volume ratio reduced by about 50%* * As compared to EX-10 series

The world's thinnest* sensor dimension of 3 mm 0.118 in has been achieved by utilizing new semiconductor packaging technology that does not use wire bonding. The small unit size allows installation of sensors in a narrow space where only a conventional fiber sensor head could be installed before. The built-in amplifier also saves on installation space.

* Among photoelectric sensors with built-in amplifier, as of April 2017 in-company survey



Front sensing type	Side sensing type
<p>Approx. 50% smaller in volume ratio than EX-10</p> 	<p>Approx. 35% smaller in volume ratio than EX-10</p> 
<p>EX-Z1□F□ W8 × H14 × D3 mm W0.315 × H0.551 × D0.118 in</p>	<p>EX-Z1□ W5.5 × H15.9 × D6.5 mm W0.217 × H0.626 × D0.256 in</p>

- FIBER SENSORS
- LASER SENSORS
- PHOTOELECTRIC SENSORS
- MICRO PHOTOELECTRIC SENSORS
- AREA SENSORS
- SAFETY LIGHT CURTAINS / SAFETY COMPONENTS
- PRESSURE / FLOW SENSORS
- INDUCTIVE PROXIMITY SENSORS
- PARTICULAR USE SENSORS
- SENSOR OPTIONS
- SIMPLE WIRE-SAVING UNITS
- WIRE-SAVING SYSTEMS
- MEASUREMENT SENSORS
- STATIC CONTROL DEVICES
- LASER MARKERS
- PLC
- HUMAN MACHINE INTERFACES
- ENERGY MANAGEMENT SOLUTIONS
- FA COMPONENTS
- MACHINE VISION SYSTEMS
- UV CURING SYSTEMS

- Selection Guide
- Amplifier Built-in
- Power Supply Built-in
- Amplifier-separated

- EX-Z**
- CX-400
- CY-100
- EX-10
- EX-20
- EX-30
- EX-40
- CX-440
- EQ-30
- EQ-500
- MQ-W
- RX-LS200
- RX
- RT-610

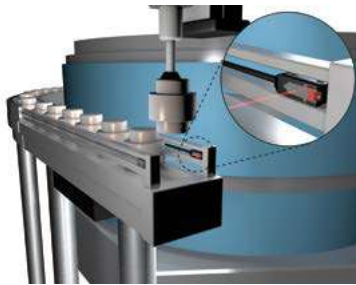
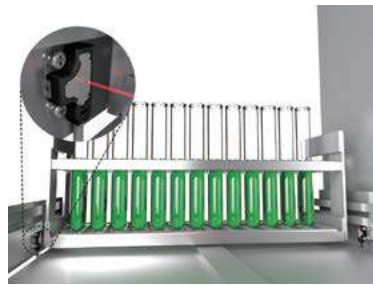
APPLICATIONS**Detection of parts in parts feeder****Detection of presence / absence of test tube tray****Detection of LED lead****Capable of sensing an extremely small $\varnothing 0.3$ mm $\varnothing 0.012$ in object without slit** **EX-Z11**

A slit is provided on the front side of the main sensor body. The sensor can detect a $\varnothing 0.3$ mm $\varnothing 0.012$ in object (the smallest-object sensing capability in the industry*) without using an optional slit.

* Among photoelectric sensors with built-in amplifier, as of April 2017 in-company survey

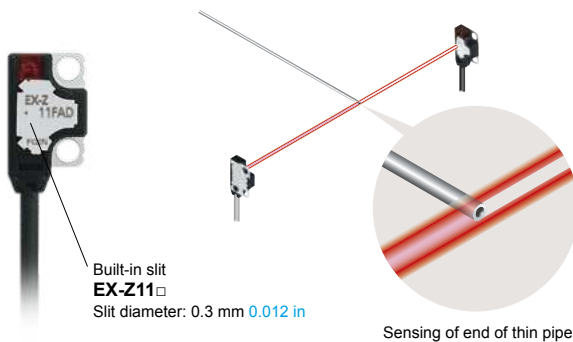
**Capability to sense a small $\varnothing 1.0$ mm $\varnothing 0.039$ in object over long distance** **EX-Z13**

The high-brightness 4-element red LED provides strong light emission stably over a long period of time. In spite of the extremely small size, both front sensing and side sensing units can sense a small $\varnothing 1.0$ mm $\varnothing 0.039$ in object from a long distance of 500 mm 19.685 in. Since the spotlight is clearly visible, the sensing position can be easily confirmed.

**ENVIRONMENTAL RESISTANCE****Bending-resistant cable type available for all models**

Bending-resistant cable type with improved flex resistance is available for all models. Select the model suitable for your specific application.

The standard type comes with lead wires with the same diameter as previous models, but the outside diameter of the cable is 2.0 mm 0.079 in and thinner than the cables of the EX-10 series. This facilitates cable routing.

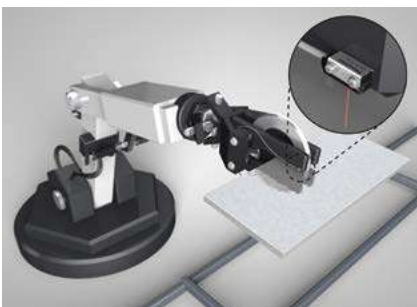
**Waterproof IP67**

The sensors features an IP67 rating to allow their use in process lines where water is used or splashed. Rust-resistant stainless steel sensor mounting brackets and screws are available.

Note: If water splashes on the sensor during sensing operation, it may sense water as an object.



FIBER SENSORS

LASER SENSORS

PHOTOELECTRIC SENSORS

MICRO PHOTOELECTRIC SENSORS

AREA SENSORS

SAFETY LIGHT CURTAINS / SAFETY COMPONENTS

PRESSURE / FLOW SENSORS

INDUCTIVE PROXIMITY SENSORS

PARTICULAR USE SENSORS

SENSOR OPTIONS

SIMPLE WIRE-SAVING UNITS

WIRE-SAVING SYSTEMS

MEASUREMENT SENSORS

STATIC CONTROL DEVICES

LASER MARKERS

PLC

HUMAN MACHINE INTERFACES

ENERGY MANAGEMENT SOLUTIONS

FA COMPONENTS

MACHINE VISION SYSTEMS

UV CURING SYSTEMS

Selection Guide

Amplifier Built-in

Power Supply Built-in

Amplifier-separated

EX-Z**CX-400****CY-100****EX-10****EX-20****EX-30****EX-40****CX-440****EQ-30****EQ-500****MQ-W****RX-LS200****RX****RT-610**

- FIBER SENSORS
- LASER SENSORS
- PHOTO-ELECTRIC SENSORS
- MICRO PHOTO-ELECTRIC SENSORS
- AREA SENSORS
- SAFETY LIGHT CURTAINS / SAFETY COMPONENTS
- PRESSURE / FLOW SENSORS
- INDUCTIVE PROXIMITY SENSORS
- PARTICULAR USE SENSORS
- SENSOR OPTIONS
- SIMPLE WIRE-SAVING UNITS
- WIRE-SAVING SYSTEMS
- MEASUREMENT SENSORS
- STATIC CONTROL DEVICES
- LASER MARKERS
- PLC
- HUMAN MACHINE INTERFACES
- ENERGY MANAGEMENT SOLUTIONS
- FA COMPONENTS
- MACHINE VISION SYSTEMS
- UV CURING SYSTEMS
- Selection Guide
- Amplifier Built-in
- Power Supply Built-in
- Amplifier-separated
- EX-Z**
- CX-400**
- CY-100**
- EX-10**
- EX-20**
- EX-30**
- EX-40**
- CX-440**
- EQ-30**
- EQ-500**
- MQ-W**
- RX-LS200**
- RX**
- RT-610**

OPTIONS

A variety of mounting brackets are available!

A spacer for mounting at the back (1 type) for through-wall sensing and sensor mounting brackets (3 types) are available to meet a diversity of sensor installation needs.

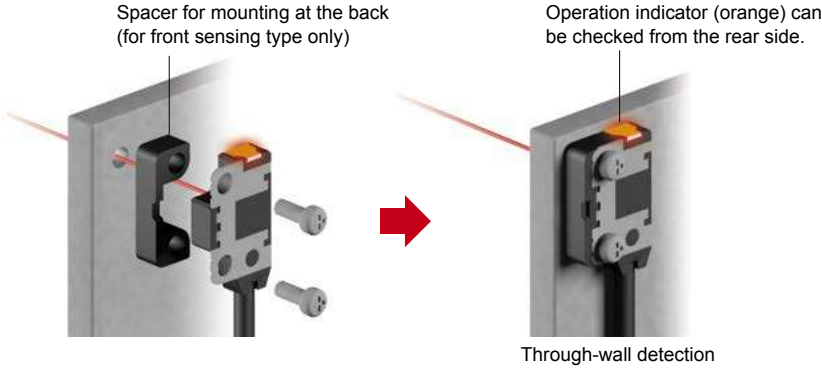

ORDER GUIDE

Type	Appearance	Sensing range	Model No. (Note)		Output operation
			NPN output	PNP output	
Thru-beam	Front sensing	50 mm 1.969 in	EX-Z11FA	EX-Z11FA-P	Light-ON
		200 mm 7.874 in	EX-Z11FB	EX-Z11FB-P	Dark-ON
		500 mm 19.685 in	EX-Z12FA	EX-Z12FA-P	Light-ON
			EX-Z12FB	EX-Z12FB-P	Dark-ON
		50 mm 1.969 in	EX-Z13FA	EX-Z13FA-P	Light-ON
			EX-Z13FB	EX-Z13FB-P	Dark-ON
	Infection resistant cable	50 mm 1.969 in	EX-Z11FA-R	EX-Z11FA-P-R	Light-ON
		200 mm 7.874 in	EX-Z11FB-R	EX-Z11FB-P-R	Dark-ON
		500 mm 19.685 in	EX-Z12FA-R	EX-Z12FA-P-R	Light-ON
			EX-Z12FB-R	EX-Z12FB-P-R	Dark-ON
		500 mm 19.685 in	EX-Z13FA-R	EX-Z13FA-P-R	Light-ON
			EX-Z13FB-R	EX-Z13FB-P-R	Dark-ON
Side sensing	Infection resistant cable	50 mm 1.969 in	EX-Z11A	EX-Z11A-P	Light-ON
		200 mm 7.874 in	EX-Z11B	EX-Z11B-P	Dark-ON
		500 mm 19.685 in	EX-Z12A	EX-Z12A-P	Light-ON
			EX-Z12B	EX-Z12B-P	Dark-ON
		500 mm 19.685 in	EX-Z13A	EX-Z13A-P	Light-ON
			EX-Z13B	EX-Z13B-P	Dark-ON
	Infection resistant cable	50 mm 1.969 in	EX-Z11A-R	EX-Z11A-P-R	Light-ON
		200 mm 7.874 in	EX-Z11B-R	EX-Z11B-P-R	Dark-ON
		500 mm 19.685 in	EX-Z12A-R	EX-Z12A-P-R	Light-ON
			EX-Z12B-R	EX-Z12B-P-R	Dark-ON
		500 mm 19.685 in	EX-Z13A-R	EX-Z13A-P-R	Light-ON
			EX-Z13B-R	EX-Z13B-P-R	Dark-ON

NOTE: Mounting bracket is not supplied with the sensor. Please select from the range of optional sensor mounting brackets (**MS-EXZ-□**).

Note: The model No. with "E" shown on the label affixed to the thru-beam type sensor is the emitter, "D" shown on the label is the receiver.

OPTIONS

Designation	Model No.	Description
Sensor mounting bracket	MS-EXZ-1	L-shaped mounting bracket (SUS304) for front sensing and side sensing types (2 sets are required)
	MS-EXZ-2	Mounting bracket (SUS304) for front sensing type (2 sets are required)
	MS-EXZ-3	Mounting bracket (SUS304) for side sensing type (2 sets are required)
Spacer for mounting at the back	MS-EXZ-4	Spacer for mounting at the back (polyacetal) for front sensing type One set consists of 10 pcs.

Sensor mounting bracket

• **MS-EXZ-1**

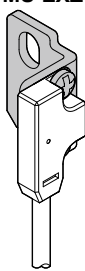

Material: Stainless steel (SUS304)
Two M2 (length 4 mm 0.157 in) pan head screws and two M2 (length 8 mm 0.315 in) pan head screws are attached.

• **MS-EXZ-2**

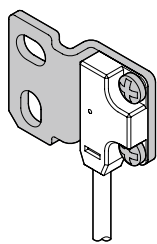

Material: Stainless steel (SUS304)
Two M2 (length 4 mm 0.157 in) pan head screws are attached.

• **MS-EXZ-3**

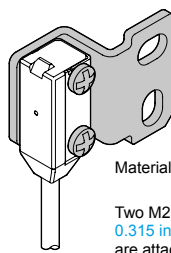

Material: Stainless steel (SUS304)
Two M2 (length 8 mm 0.315 in) pan head screws are attached.

Spacer for mounting at the back

• **MS-EXZ-4**

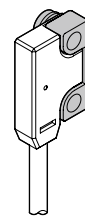

Material: Polyacetal
M2 (length: 10 mm 0.394 in) screws, nuts, spring washers and flat washers are attached. (20 pieces each)

PRECAUTIONS FOR PROPER USE

Refer to p.1552~ for general precautions.



- Never use this product as a sensing device for personnel protection.
- In case of using sensing devices for personnel protection, use products which meet laws and standards, such as OSHA, ANSI or IEC etc., for personnel protection applicable in each region or country.

Mounting

• In case of mounting on tapped holes (Unit: mm in)

Side sensing

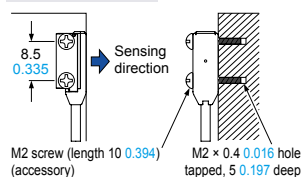

Front sensing

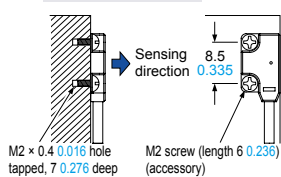

The tightening torque should be 0.2 N·m or less.

• In case of using attached screws and nuts (Unit: mm in)

Side sensing

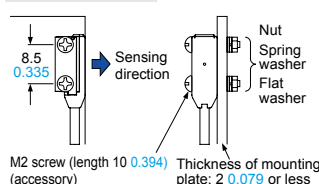

Front sensing

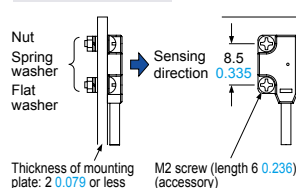

The tightening torque should be 0.2 N·m or less.

Other

- Do not use during the initial transient time (0.5 sec. approx.) after the power supply is switched on.

- FIBER SENSORS
- LASER SENSORS
- PHOTO-ELECTRIC SENSORS
- MICRO PHOTO-ELECTRIC SENSORS
- AREA SENSORS
- SAFETY LIGHT CURTAINS / SAFETY COMPONENTS
- PRESSURE / FLOW SENSORS
- INDUCTIVE PROXIMITY SENSORS
- PARTICULAR USE SENSORS
- SENSOR OPTIONS
- SIMPLE WIRE-SAVING UNITS
- WIRE-SAVING SYSTEMS
- MEASUREMENT SENSORS
- STATIC CONTROL DEVICES
- LASER MARKERS
- PLC
- HUMAN MACHINE INTERFACES
- ENERGY MANAGEMENT SOLUTIONS
- FA COMPONENTS
- MACHINE VISION SYSTEMS
- UV CURING SYSTEMS
- Selection Guide
- Amplifier Built-in
- Power Supply Built-in
- Amplifier-separated
- EX-Z**
- CX-400**
- CY-100**
- EX-10**
- EX-20**
- EX-30**
- EX-40**
- CX-440**
- EQ-30**
- EQ-500**
- MQ-W**
- RX-LS200**
- RX**
- RT-610**

SPECIFICATIONS

Item	Type		Thru-beam					
			Front sensing	Side sensing	Front sensing	Side sensing	Front sensing	Side sensing
	Model No. (Note 2)	Light-ON	EX-Z11FA(-P)(-R)	EX-Z11A(-P)(-R)	EX-Z12FA(-P)(-R)	EX-Z12A(-P)(-R)	EX-Z13FA(-P)(-R)	EX-Z13A(-P)(-R)
		Dark-ON	EX-Z11FB(-P)(-R)	EX-Z11B(-P)(-R)	EX-Z12FB(-P)(-R)	EX-Z12B(-P)(-R)	EX-Z13FB(-P)(-R)	EX-Z13B(-P)(-R)
CE marking directive compliance	EMC Directive, RoHS Directive							
Sensing distance	50 mm 1.969 in		200 mm 7.874 in		500 mm 19.685 in			
Minimum sensing object	$\varnothing 0.3$ mm $\varnothing 0.012$ in opaque object (Completely beam interrupted object) (Setting distance between emitter and receiver: 50 mm 1.969 in)		$\varnothing 0.5$ mm $\varnothing 0.02$ in opaque object (Completely beam interrupted object) (Setting distance between emitter and receiver: 200 mm 7.874 in)		$\varnothing 1.0$ mm $\varnothing 0.039$ in opaque object (Completely beam interrupted object) (Setting distance between emitter and receiver: 500 mm 19.685 in)			
Hysteresis	—							
Repeatability (Perpendicular to sensing axis)	0.02 mm 0.001 in or less		0.03 mm 0.001 in or less		0.05 mm 0.002 in or less			
Supply voltage	12 to 24 V DC ± 10 % Ripple P-P 10 % or less							
Current consumption	Emitter: 10 mA or less, Receiver: 10 mA or less							
Output	<NPN output type> NPN open-collector transistor • Maximum sink current: 20 mA • Applied voltage: 30 V DC or less (between output and 0 V) • Residual voltage: 1.5 V or less (at 20 mA sink current)			<PNP output type> PNP open-collector transistor • Maximum source current: 20 mA • Applied voltage: 30 V DC or less (between output and +V) • Residual voltage: 1.5 V or less (at 20 mA source current)				
Short-circuit protection	Incorporated							
Response time	0.5 ms or less							
Operation indicator	Orange LED (Lights up when the sensing output is ON)							
Stability indicator	Green LED (Lights up under the stable light received condition or the stable dark condition)							
Environment resistance	Protection	IP67 (IEC)						
	Ambient temperature	-10 to +55 °C 14 to +131 °F (No dew condensation or icing allowed), Storage: -30 to +70 °C -22 to +158 °F						
	Ambient humidity	35 to 85 % RH, Storage: 35 to 85 % RH						
	Ambient illuminance	Incandescent light: 5,000 lx or less at the light-receiving face						
	Voltage withstandability	1,000 V AC for one min. between all supply terminals connected together and enclosure						
	Insulation resistance	20 M Ω or more, with 250 V DC megger between all supply terminals connected together and enclosure						
	Vibration resistance	10 to 500 Hz frequency, 3 mm 0.118 in double amplitude in X, Y and Z directions for two hours each						
	Shock resistance	500 m/s ² acceleration (50 G approx.) in X, Y and Z directions three times each						
Light emitting element	Red LED (Peak emission wavelength: 650 nm 0.026 mil , modulated)							
Grounding	Floating							
Material	Enclosure: PBT, Lens: Polycarbonate, Metallic part: Stainless steel (SUS304) (SUS301 for rear side of front sensing type)							
Cable (Note 3)	0.1 mm ² 3-core (emitter: 2-core) cabtyre cable, 2 m 6.562 ft long							
Cable extension	Extension up to total 50 m 164 ft is possible with 0.3 mm ² , or more, cable (both emitter and receiver).							
Weight	Net weight (each emitter and receiver): 15 g approx., Gross weight: 35 g approx.							
Accessories	M2 mounting screws [Stainless steel (SUS304)]: 1 set (front sensing type: 6 mm 0.236 in in length; side sensing type: 10 mm 0.394 in in length)							

- Notes: 1) Where measurement conditions have not been specified precisely, the conditions used were an ambient temperature of +23°C 73°F.
 2) Model Nos. having the "-P" are PNP output type and model Nos. having the "-R" are bending-resistant cable type.
 3) The bending-resistant cable type has a 0.1 mm² 3-core (thru-beam type emitter: 2-core) bending-resistant cabtyre cable, 2 m **6.562 ft** long.

EX-Z

CX-400

CY-100

EX-10

EX-20

EX-30

EX-40

CX-440

EQ-30

EQ-500

MQ-W

RX-LS200

RX

RT-610

I/O CIRCUIT DIAGRAMS

NPN output type

I/O circuit diagram

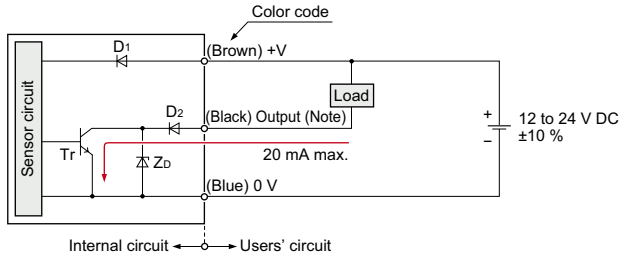

Note: The emitter does not incorporate the output.

Symbols ... D1: Reverse supply polarity protection diode
 D2: Reverse output polarity protection diode
 ZD: Surge absorption zener diode
 Tr: NPN output transistor

PNP output type

I/O circuit diagram

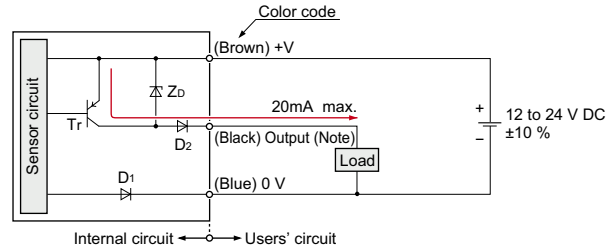

Note: The emitter does not incorporate the output.

Symbols ... D1: Reverse supply polarity protection diode
 D2: Reverse output polarity protection diode
 ZD: Surge absorption zener diode
 Tr: PNP output transistor

SENSING CHARACTERISTICS (TYPICAL)

EX-Z11F □ EX-Z11 □

Thru-beam type

Parallel deviation

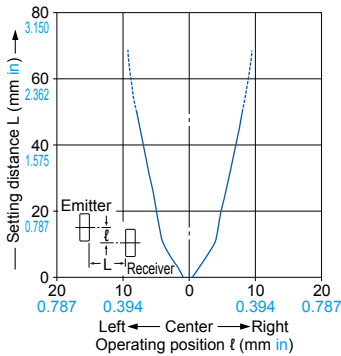

Angular deviation

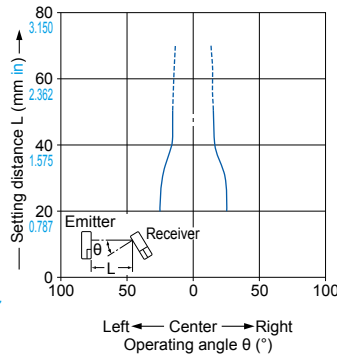

EX-Z12F □ EX-Z12 □

Thru-beam type

Parallel deviation

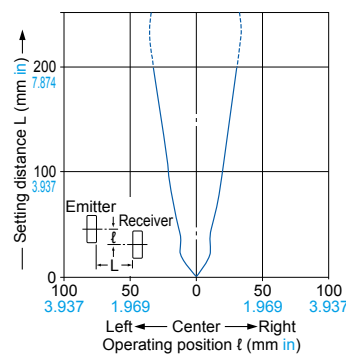

Angular deviation

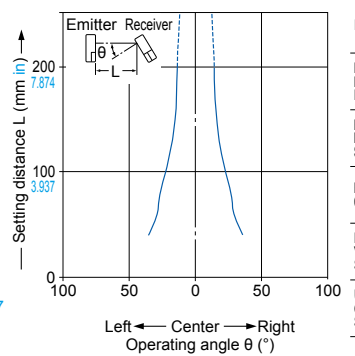

EX-Z13F □ EX-Z13 □

Thru-beam type

Parallel deviation

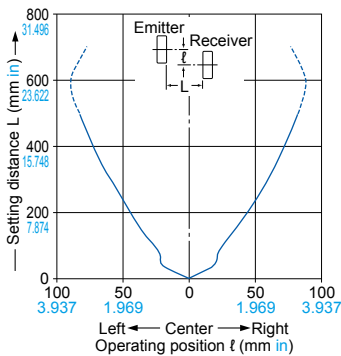

Angular deviation

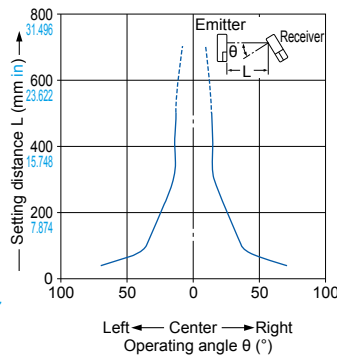

FIBER SENSORS

LASER SENSORS

PHOTO-ELECTRIC SENSORS

MICRO PHOTO-ELECTRIC SENSORS

AREA SENSORS

SAFETY LIGHT CURTAINS / SAFETY COMPONENTS

PRESSURE / FLOW SENSORS

INDUCTIVE PROXIMITY SENSORS

PARTICULAR USE SENSORS

SENSOR OPTIONS

SIMPLE WIRE-SAVING UNITS

WIRE-SAVING SYSTEMS

MEASUREMENT SENSORS

STATIC CONTROL DEVICES

LASER MARKERS

PLC

HUMAN MACHINE INTERFACES

ENERGY MANAGEMENT SOLUTIONS

FA COMPONENTS

MACHINE VISION SYSTEMS

UV CURING SYSTEMS

Selection Guide

Amplifier Built-in

Power Supply Built-in

Amplifier-separated

EX-Z

CX-400

CY-100

EX-10

EX-20

EX-30

EX-40

CX-440

EQ-30

EQ-500

MQ-W

RX-LS200

RX

RT-610

DIMENSIONS (Unit: mm in)

The CAD data can be downloaded from the website.

EX-Z11F □ EX-Z12F □ EX-Z13F □

Sensor

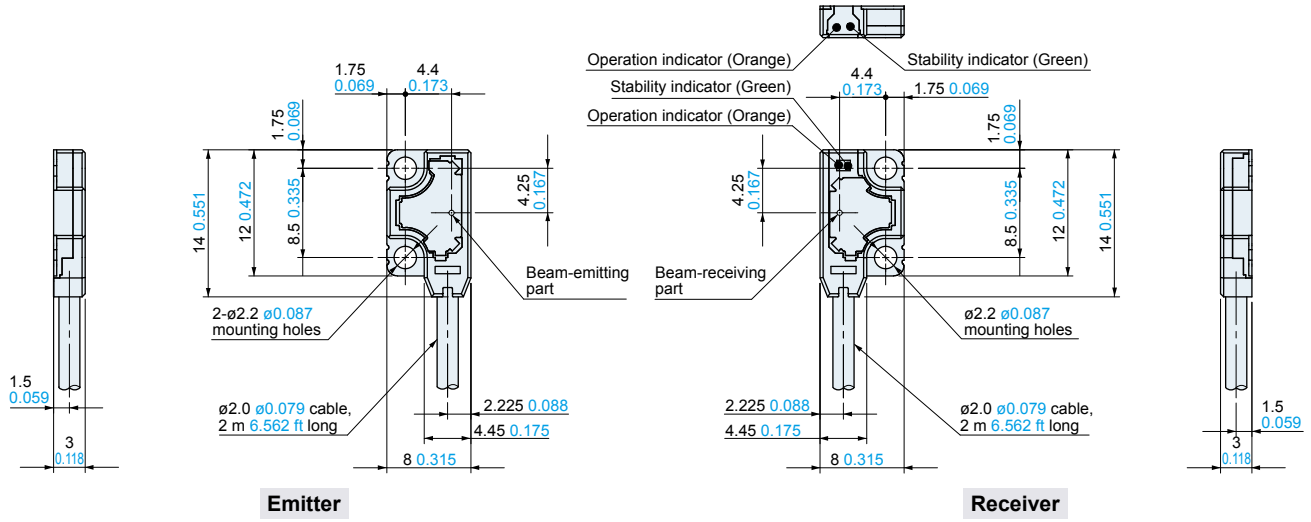

EX-Z11 □ EX-Z12 □ EX-Z13 □

Sensor

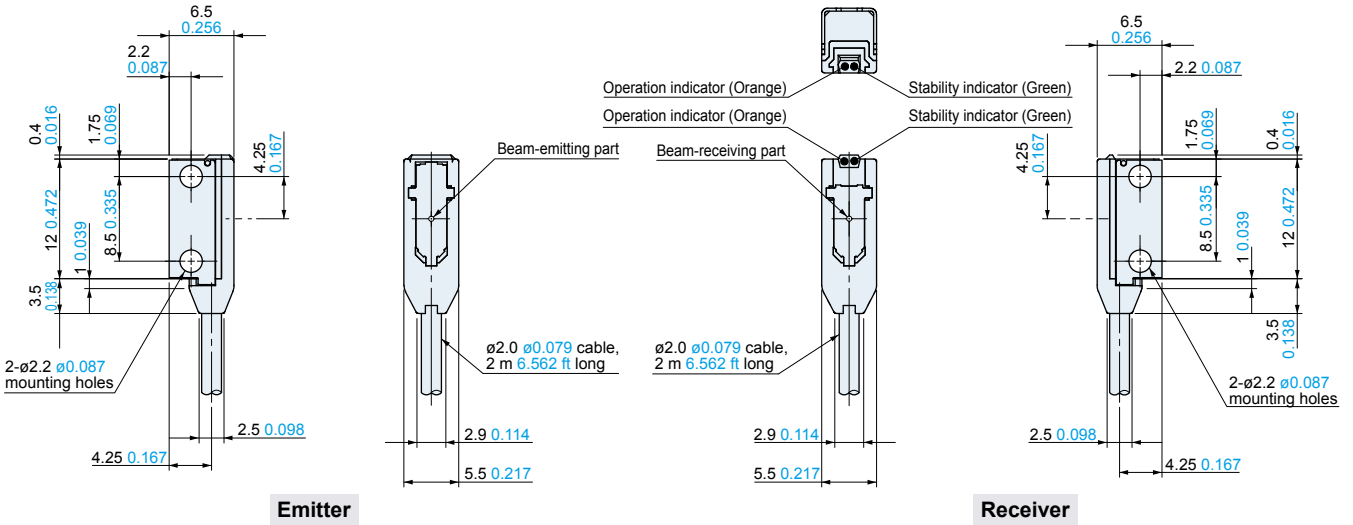

MS-EXZ-1 Sensor mounting bracket (Optional)

MS-EXZ-2 Sensor mounting bracket (Optional)

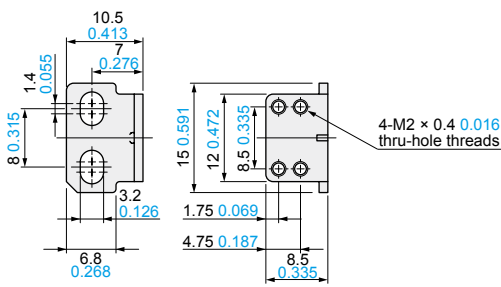

Material: Stainless steel (SUS304)

Two M2 (length 4 mm 0.157 in) pan head screws and two M2 (length 8 mm 0.315 in) pan head screws are attached.

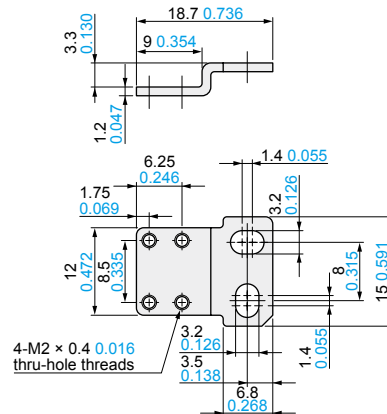

Material: Stainless steel (SUS304)

Two M2 (length 4 mm 0.157 in) pan head screws are attached.

- FIBER SENSORS
- LASER SENSORS
- PHOTO-ELECTRIC SENSORS
- MICRO PHOTO-ELECTRIC SENSORS
- AREA SENSORS
- SAFETY LIGHT CURTAINS / SAFETY COMPONENTS
- PRESSURE / FLOW SENSORS
- INDUCTIVE PROXIMITY SENSORS
- PARTICULAR USE SENSORS
- SENSOR OPTIONS
- SIMPLE WIRE-SAVING UNITS
- WIRE-SAVING SYSTEMS
- MEASUREMENT SENSORS
- STATIC CONTROL DEVICES
- LASER MARKERS
- PLC
- HUMAN MACHINE INTERFACES
- ENERGY MANAGEMENT SOLUTIONS
- FA COMPONENTS
- MACHINE VISION SYSTEMS
- UV CURING SYSTEMS
- Selection Guide
- Amplifier Built-in
- Power Supply Built-in
- Amplifier-separated
- EX-Z**
- CX-400
- CY-100
- EX-10
- EX-20
- EX-30
- EX-40
- CX-440
- EQ-30
- EQ-500
- MQ-W
- RX-LS200
- RX
- RT-610

DIMENSIONS (Unit: mm in)

The CAD data can be downloaded from the website.

MS-EXZ-3 Sensor mounting bracket (Optional)

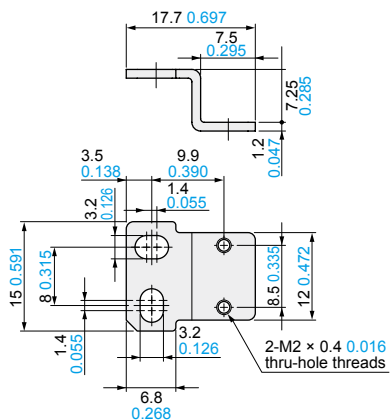

Material: Stainless steel (SUS304)

Two M2 (length 8 mm 0.315 in) pan head screws are attached.

MS-EXZ-4 Spacer for mounting at the back (Optional)

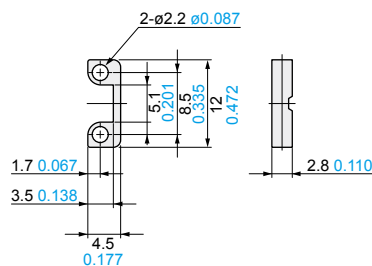

Material: Polyacetal

Set of 10 pieces
M2 (length: 10 mm 0.394 in) screws, nuts, spring washers and flat washers are attached. (20 pieces each)

FIBER SENSORS

LASER SENSORS

PHOTO-ELECTRIC SENSORS

MICRO PHOTO-ELECTRIC SENSORS

AREA SENSORS

SAFETY LIGHT CURTAINS / SAFETY COMPONENTS

PRESSURE / FLOW SENSORS

INDUCTIVE PROXIMITY SENSORS

PARTICULAR USE SENSORS

SENSOR OPTIONS

SIMPLE WIRE-SAVING UNITS

WIRE-SAVING SYSTEMS

MEASUREMENT SENSORS

STATIC CONTROL DEVICES

LASER MARKERS

PLC

HUMAN MACHINE INTERFACES

ENERGY MANAGEMENT SOLUTIONS

FA COMPONENTS

MACHINE VISION SYSTEMS

UV CURING SYSTEMS

Selection Guide

Amplifier Built-in

Power Supply Built-in

Amplifier-separated

EX-Z

CX-400

CY-100

EX-10

EX-20

EX-30

EX-40

CX-440

EQ-30

EQ-500

MQ-W

RX-LS200

RX

RT-610