

Micro Laser Distance Sensor [CMOS]  
HG-C Series

ME-HGC1000 No.0059-28V

Thank you very much for purchasing Panasonic products. Please read this Instruction Manual carefully and thoroughly for the correct and optimum use of this product. Kindly keep this manual in a convenient place for quick reference.

**WARNING**

- This product is for the sensing (determination and measurement) of objects. Do not use this product to secure safety, such as accident prevention which may affect human life and property.
- Do not stare directly into the laser beam, or through observation optical equipment, such as lenses or etc. as it is dangerous.

**1 INTENDED PRODUCTS FOR CE MARKING**

- This product complies with the following standards / regulations.

<EU Directive>

EMC Directive

<Standards in US / Canada>

CAN/CSA-C22.2 NO. 60947-5-2-14



**2 CONFIRMATION OF PACKED CONTENTS**

- Sensor 1 pc.
- Laser warning label (JIS Standards, GB Standard) 1 set each
- FDA certification label 1 pc.
- Instruction Manual (Japanese, English, Korean) 1 pc. each language
- General Information for Safety, Compliance, and Instructions (23 languages) 1 pc.

**3 SAFE USE OF LASER PRODUCT**

- For the purpose of preventing any injury which may occur to the user by the use of the laser product in advance, the following standards have been established by the IEC Standards, JIS Standards, GB Standards and FDA Standards.

- IEC : IEC 60825-1-2014
- JIS : JIS C 6802-2014
- GB : GB 7247.1-2012
- FDA : PART 1040.10

These standards classifies laser products according to the level of hazard and provide the safety measures for respective classes.

• **FDA Standards Outline**

Requirements	Class <sup>*1</sup>					
	I	IIa	II	IIIa	IIIb	IV
Performance (all laser products)						
Protective housing [1040.10 (f) (1)]	R <sup>2</sup>	R <sup>2</sup>	R <sup>2</sup>	R <sup>2</sup>	R <sup>2</sup>	R <sup>2</sup>
Safety interlocks [1040.10 (f) (2)]	R <sup>3,4</sup>	R <sup>3,4</sup>	R <sup>3,4</sup>	R <sup>3,4</sup>	R <sup>3,4</sup>	R <sup>3,4</sup>
Location of controls [1040.10 (f) (7)]	R	R	R	R	R	R
Viewing optics [1040.10 (f) (8)]	R	R	R	R	R	R
Scanning safeguards [1040.10 (f) (9)]	R	R	R	R	R	R
Performance (laser system)						
Remote control connector [1040.10 (f) (3)]	N/A	N/A	N/A	N/A	R	R
Key control [1040.10 (f) (4)]	N/A	N/A	N/A	N/A	R	R
Emission indicator [1040.10 (f) (5)]	N/A	N/A	R	R	R <sup>10</sup>	R <sup>10</sup>
Beam attenuator [1040.10 (f) (6)]	N/A	N/A	R	R	R	R
Reset [1040.10 (f) (10)]	N/A	N/A	N/A	N/A	N/A	R <sup>13</sup>
Performance (specific-purpose products)						
Medical [1040.11 (a)]	S	S	S	S <sup>9</sup>	S <sup>9</sup>	S <sup>9</sup>
Measurement, leveling, alignment [1040.11 (b)]	S	S	S	S	NP	NP
Demonstration [1040.11 (c)]	S	S	S	S	S <sup>11</sup>	S <sup>11</sup>
Labeling (all laser products)						
Certification / identification [1010.2.3]	R	R	R	R	R	R
Protective housing [1040.10 (g) (6), (7)]	D <sup>5</sup>	R <sup>5</sup>	R <sup>5</sup>	R <sup>5</sup>	R <sup>5</sup>	R <sup>5</sup>
Aperture [1040.10 (g) (4)]	N/A	N/A	R	R	R	R
Class warning [1040.10 (g) (1), (2), (3)]	N/A	R <sup>6</sup>	R <sup>7</sup>	R <sup>9</sup>	R <sup>12</sup>	R <sup>12</sup>
Information (all laser products)						
User information [1040.10 (h) (1)]	R	R	R	R	R	R
Product literature [1040.10 (h) (2) (i)]	N/A	R	R	R	R	R
Service information [1040.10 (h) (2) (ii)]	R	R	R	R	R	R

R : Required  
N/A: Not applicable  
S : Same as for other products of that Class. Also see footnotes.  
NP : Not permitted  
D : Depends on level of interior radiation.

\*1 : Class is based on the maximum level of laser exposure during operation.  
\*2 : Required wherever and whenever human access to laser radiation above Class I limits is not needed for products to perform its functions.  
\*3 : Required for protective housings opened during operation or maintenance, if human access thus gained is not always necessary when housing is opened.  
\*4 : The requirements for interlock differ depending on the class of inner radiation.  
\*5 : The contents of label differ depending on the level and wavelength of laser radiation inside the protective housing.  
\*6 : Warning statement label.  
\*7 : CAUTION logotype.  
\*8 : The method to measure the level of laser radiation to human body is required.  
\*9 : CAUTION if 2.5mW/cm<sup>2</sup> or less, DANGER is greater than 2.5mW/cm<sup>2</sup>  
\*10 : Delay required between indication and emission.  
\*11 : Exception should be provided for demonstration of laser products or light shows using laser of Class IIIb or IV.  
\*12 : DANGER logotype.  
\*13 : Required after August 20, 1986.

• **WARNING label**

In Japanese



In English



In Chinese



• **FDA certification label**



<Label position>

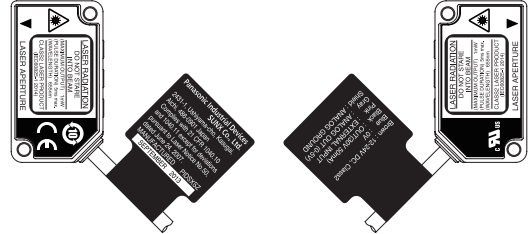

- An English warning label is attached to this product. When this product is used in Japan or China, peel off the English warning label, and attach the Japanese or Chinese warning label.
- When exporting this product to the United State of America attach the FDA certification label to the cable close to the sensing device.

**4 PART DESCRIPTION**

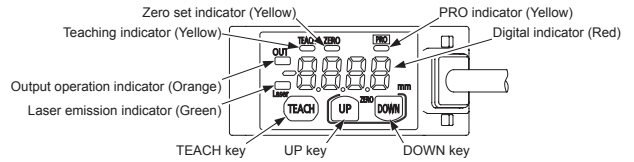

**5 MOUNTING**

- When mounting this product, use M3 screws (prepare separately). Use a tightening torque of 0.5N·m for mounting.
- When mounting this product using the sensor mounting bracket (optional), also use a tightening torque of 0.5N·m.

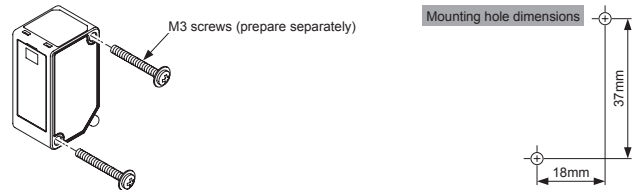

**Mounting Direction**

• **Direction to a movable body**

<When there are differences in material and color>

- When performing measurements of moving objects with excessively different materials and colors, mount the product per the following directions to minimize measurement errors.

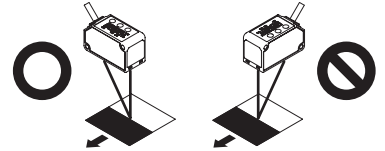

<Measurement of rotating objects>

- When measuring rotating objects, mount the product as follows. Measurement can be performed with minimized effect on the object caused by up / down deflection, position deviation and etc.

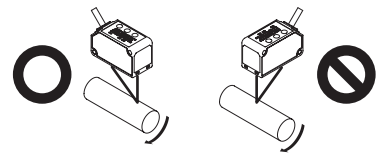

<When there is a step>

- When there is a step in the moving object, mount the product as follows. Measurement can be performed with minimized effect from the edges of the steps.

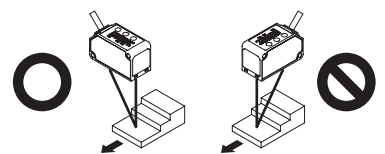

• **Measuring of narrow locations and recesses**

- When measuring in narrow locations or inside holes, mount the product so that optical path from the light emitting part to light-receiving part is not interrupted.

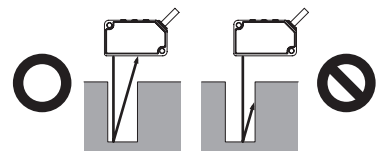

**Mounting the sensor to a wall**

- Mount the product as follows, so that the multiple light reflections on the wall do not emit to the light-receiving part. When the reflection factor on a wall is high, it is effective to use a dull black color.

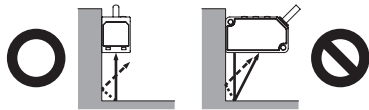

**6 I/O CIRCUIT DIAGRAMS**

**NPN Output Type**

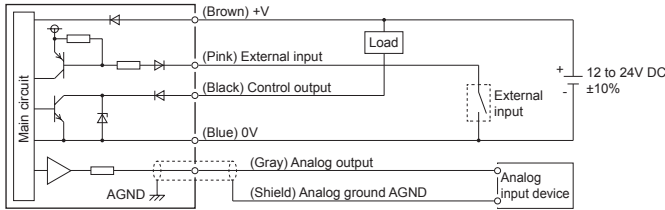

**PNP Output Type**

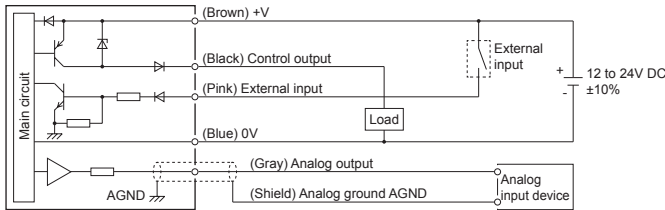

**7 TEACHING**

**2-point teaching**

- This is the basic teaching method.

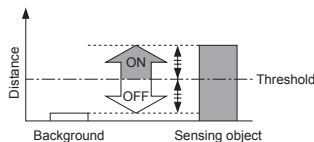
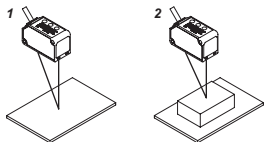

- Press the TEACH key in the background present condition.
- Press the TEACH key in the sensing object present condition.

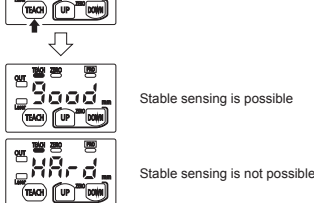

**Limit-teaching**

- This is teaching method in case small object or object in background are existing.

**<When an object in background is used as reference>**

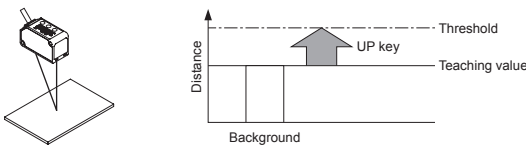

**<When a sensing object is used as reference>**

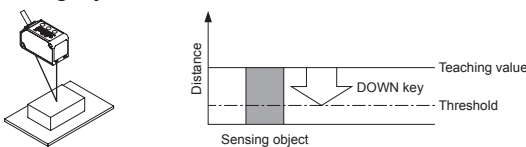

- Press the TEACH key in the background present condition or the sensing object present condition.
- When an object in the background is used as a reference, press the UP key to set the threshold on the sensor side. When a sensing object is used as a reference, press the DOWN key to set the threshold on the sensing object side.
- Teaching is completed.

**1-point teaching (Window comparator mode)**

- This mode is used for setting the threshold range for the distance from the reference value of the sensing object, by performing 1-point teaching. This mode is used for sensing within the threshold range.
- When performing 1-point teaching (window comparator mode), preset "Window comparator mode 1" in the sensing output setting of the PRO mode. For the setting method, refer to "12 PRO MODE SETTING."

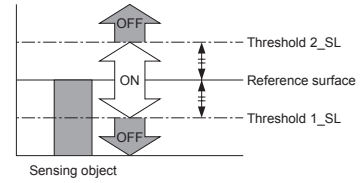

- Press the TEACH key twice in the sensing object present condition. (1st time: TEACH mode, 2nd time: Teaching)
- Teaching is completed.

**2-point teaching (Window comparator mode)**

- This is method to set the threshold range by conducting the 2-point teaching.
- When performing 2-point teaching (window comparator mode), preset "Window comparator mode 2" in the sensing output setting of the PRO mode. For the setting, refer to "12 PRO MODE SETTING."
- When conducting teaching, use sensing objects (P-1 and P-2) whose distance are different from each other.

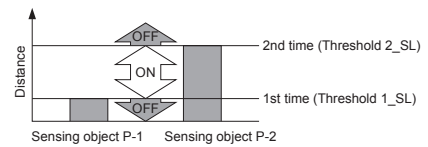

- Press the TEACH key in the sensing object P-1 present condition. (1st time)
  - Press the TEACH key in the sensing object P-2 present condition. (2nd time)
- Stable sensing is possible
- Stable sensing is not possible

**3-point teaching (Window comparator mode)**

- This is the method to perform 3-point teaching (P-1, P-2, P-3) and to set the threshold range by setting threshold 1\_SL in the mid-point between the 1st time and 2nd time, and threshold 2\_SL in the mid-point between the 2nd time and 3rd time as shown in the following figure.
- When performing 3-point teaching (window comparator mode), preset "Window comparator mode 3" in the sensing output setting of the PRO mode. For the setting, refer to "12 PRO MODE SETTING."
- When performing teaching, use sensing objects (P-1, P-2, P-3) with different distance.
- After teaching, P-1, P-2 and P-3 will be automatically rearranged from the smaller value.

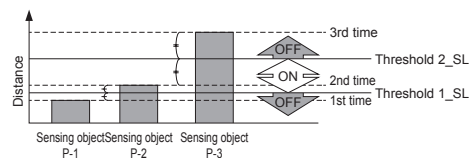

- Press the TEACH key in the sensing object P-1 present condition. (1st time)
  - Press the TEACH key in the sensing object P-2 present condition. (2nd time)
  - Press the TEACH key in the sensing object P-3 present condition. (3rd time)
- Stable sensing is possible
- Stable sensing is not possible

### Span adjustment in rising differential mode or trailing differential mode

- This mode is used to cancel the gradual changes in the measured value, and to only detect sudden changes.
- When performing rising differential mode or trailing differential mode, preset "Rising differential mode" or "Trailing differential mode" in the sensing output setting of the PRO mode. For the setting method, refer to "12 PRO MODE SETTING."
- The threshold can be set by using the threshold value fine adjustment function. For the threshold value fine adjustment function, refer to "8 THRESHOLD VALUE FINE ADJUSTMENT FUNCTION."

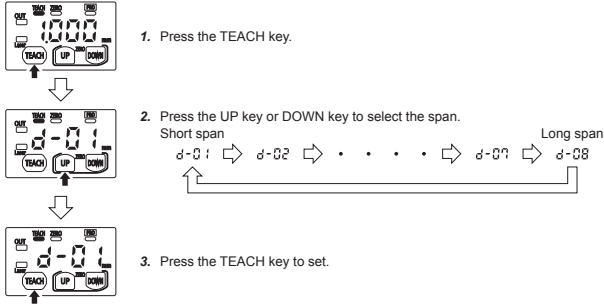

### 8 THRESHOLD VALUE FINE ADJUSTMENT FUNCTION

- Fine adjustment of the threshold can be performed in the measurement display.
- Fine adjustment of the threshold can be performed even after teaching.

#### <Normal sensing mode, rising differential mode or trailing differential mode>

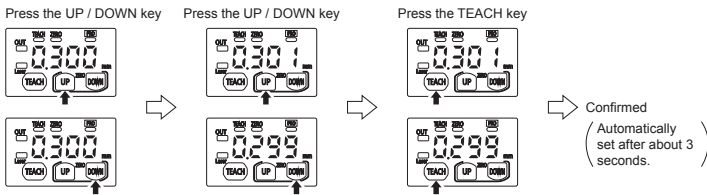

#### <Window comparator mode>

- When the sensing output is set to window comparator mode, the display of "1.5L" and "2.5L" can be changed by pressing the TEACH key for 1 second.

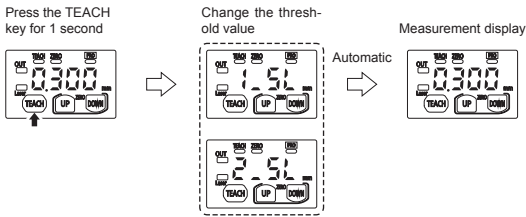

- When performing a fine adjustment of the threshold of "1.5L" or "2.5L", press the UP key or DOWN key. After "1.5L" or "2.5L" is displayed, the fine adjustment of the threshold can be performed.

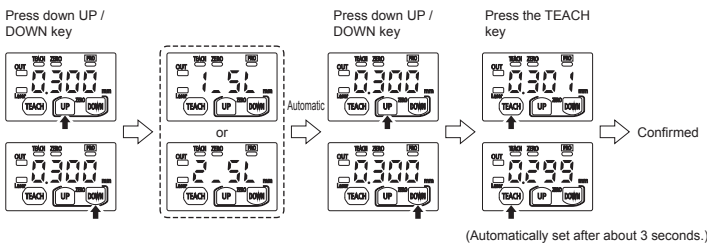

### 9 PEAK / BOTTOM HOLD FUNCTION

- The peak / bottom hold function, is for displaying the peak value and bottom value.
- When the zero set function is executed while the peak / bottom hold function is set to "Peak hold" or "Bottom hold", the held measured value will be reset.

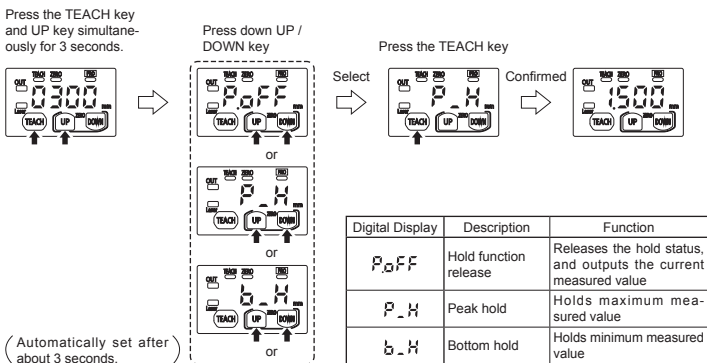

### 10 ZERO SET FUNCTION

- The zero set function is the function to compulsorily set the measured value to "zero".
- The zero set indicator (yellow) will turn ON when the zero set is valid.
- When the zero set function is executed while the peak / bottom hold function is valid, the held measured value will be reset.
- When the display setting is set to Offset, the zero set function cannot be set.

#### <Zero set setting>

Press the UP key and DOWN key simultaneously for 3 seconds.



#### <Zero set release>

Press the UP key and DOWN key simultaneously for 6 seconds.

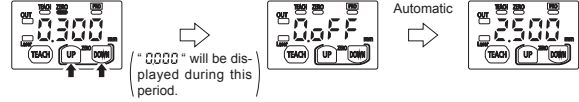

- The setting or releasing of the zero set from an external input operates as in the following figure.

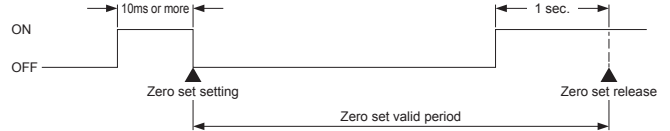

- When the power is turned ON again, zero set from external input can be released. At this time, the zero set will not be saved.
- Even when the zero set is set in the sensor, the zero set can be set or released from an external input. However, when the power is turned ON again, the zero set set in the sensor will be displayed.

### 11 KEY LOCK FUNCTION

- The key lock function is to prevent acceptance of key operations, so that the conditions set in each setting mode are not changed accidentally.
- When key operation is performed after the key lock is set, "L.O.C" will be displayed on the digital display.

#### <Key lock setting>

Press the TEACH key and DOWN key simultaneously for 3 seconds.

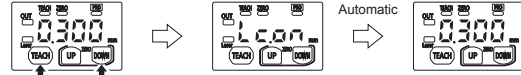

#### <Key lock release>

Press the TEACH key and DOWN key simultaneously for 3 seconds.

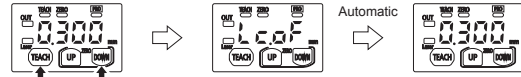

### 12 PRO MODE SETTING

#### Part description

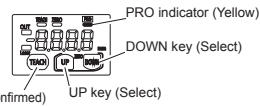

#### Arrow description in figures

- ↔ : Press the TEACH key
- ↕ : Press UP key or DOWN key
- ⋮ : Press DOWN key

TEACH key (Confirmed)  
UP key (Select)

- The PRO indicator (yellow) will turn ON when the PRO mode is set.
- When the DOWN key is pressed for 3 seconds or more in the middle of the PRO MODE setting, the display returns to the measurement display.

Item	Default setting	Description
Response speed setting	Hr50	Set the response time. "Hr50": High precision 10ms, "5td": Standard 5ms "FRStk": High speed 1.5ms
Output operation setting	L-on	Select the control output operation mode. "L-on": Light-ON, "d-on": Dark-ON
Sensing output setting	- - -	Set the sensing output. "1.1": Normal sensing mode "1.2": 1-point teaching (Window comparator mode) "1.3": 2-point teaching (Window comparator mode) "1.3": 3-point teaching (Window comparator mode) "d.1": Trailing differential mode "d.2": Trailing differential mode
Analog output setting	uout	Sets the output operation of analog output setting. "uout": Analog voltage output (0 to +5V) "iout": Analog current output (4 to 20mA)
Hysteresis setting	<HG-C1030> 0010 <HG-C1030> 0003 <HG-C1100> 0007 <HG-C1400> 08	Set the hysteresis width. HG-C1030: 0.001 to 5.00mm HG-C1050: 0.01 to 15.00mm HG-C1100: 0.02 to 35.00mm HG-C1200: 0.1 to 80.0mm HG-C1400: 0.2 to 200.0mm
External input setting	0SEt	Set the external input. "0SEt": Zero set function, "tEcH": Teaching function "L-oF": Light emitting stop function, "tRiG": Trigger function
Timer setting	non	Set the timer operation. The timer time is fixed at 5ms. "non": No timer, "oFd": OFF-delay timer "oNd": ON-delay timer, "oSh": One-shot timer
Display setting	Std	The display of the measured value can be changed. "Std": Normal, "Inv": Invert, "oFSt": Offset
Hold setting	oFF	Set the control output and the analog output operation when a measurement error occurs (insufficient light intensity, saturation of light intensity, out of measurement range). "oFF": Hold OFF, "on": Hold ON
ECO Setting	oFF	The digital display can be set to go OFF when key operation is not performed for 30 seconds. Current consumption can be reduced. "oFF": ECO OFF, "on": ECO ON
Reset setting	no	Return to the default setting (factory setting). "no": Reset NG, "yES": Reset OK

## Procedure

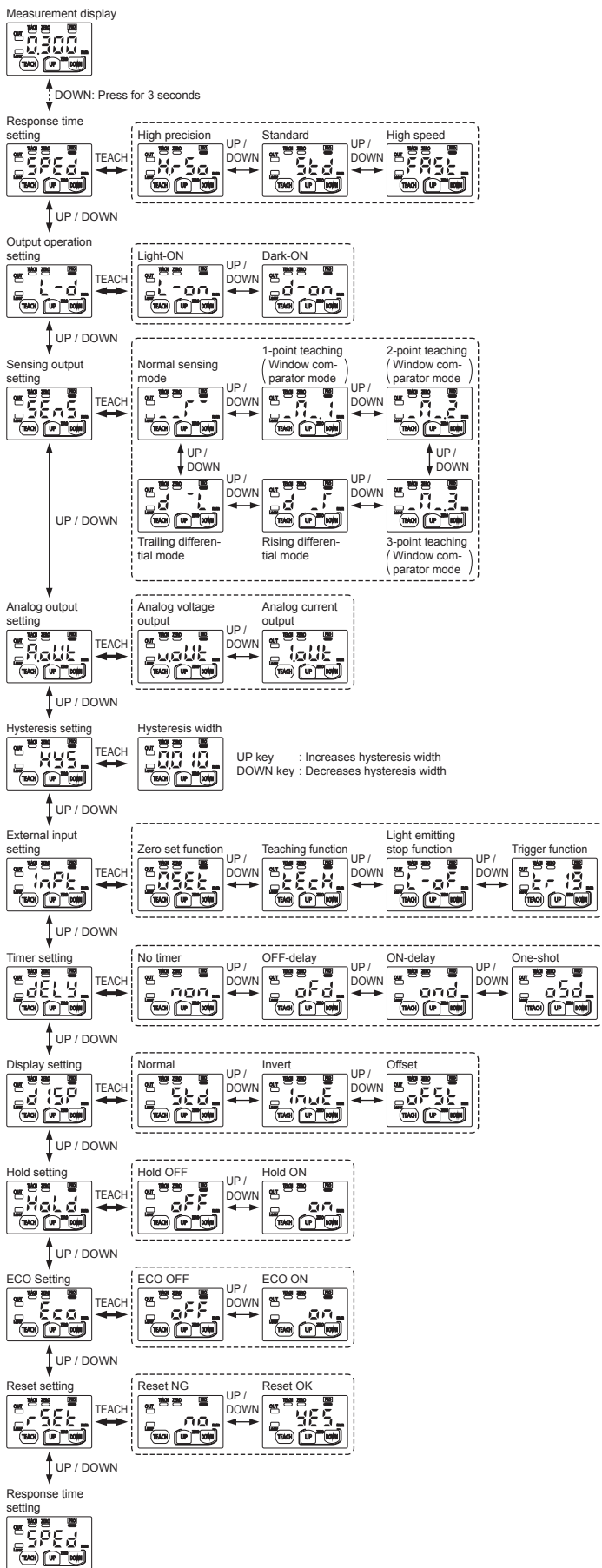

## 13 CAUTIONS

- This product has been developed / produced for industrial use only.
- Make sure that the power supply is OFF before starting the wiring.
- If the wiring is performed incorrectly, it will cause a failure.
- Do not run the wires together with high-voltage lines or power lines, or put them in the same raceway. This can cause malfunction due to induction.
- Verify that the supply voltage variation is within the rating.
- If power is supplied from a commercial switching regulator, ensure that the frame ground (F.G.) terminal of the power supply is connected to an actual ground.
- If noise generating devices (switching regulators, inverter motors, etc.) are used around the sensor mounting area, make sure to connect the frame ground (FG) terminal of the device.

- Do not use this product during the transient state when the power supply is turned ON.
- The overall length of the cable can be extended to 10m maximum with a cable size of 0.3mm<sup>2</sup> or more.
- Make sure that stress by forcible bend or pulling is not applied to the sensor cable joint.
- Although it depends on the type, light from rapid start type or high frequency lighting type fluorescent lights, sunlight and etc. may affect the sensing, therefore make sure to prevent direct incident light.
- This product is suitable for indoor use only.
- Keep water, oil, fingerprints and etc. which reflect light, or dust, particles or etc. which interrupts the light, away from the emitting / receiving surfaces of this product. If contaminants adhere to the surface, wipe off with a dust-free soft cloth, or lens cleaning paper.
- Do not use the sensor in locations where there is excessive vapor, dust or etc. or in an atmosphere where corrosive gases, etc. is generated.
- Take care that the product does not come in contact with oil, grease, organic solvents such as thinner, etc., strong acid or alkaline.
- Make sure to turn OFF the power supply, before cleaning the light emitting / receiving windows of the sensor head.
- There is a certain deviation in the directionality of this product. Install the product using a mounting bracket or similar fitting to allow the adjustment of optical axis.
- The internal memory (nonvolatile) of this product has a service life. Settings cannot be configured more than 100,000 times.

## 14 ERROR INDICATION

- In case of errors, attempt the following measures.

Error indication	Description	Remedy
<Hold OFF> ----- <Hold ON> Measured value blinks	Insufficient amount of reflected light. The sensing object is out of the sensing range.	Confirm that the sensing distance is within the specification range. Adjust the installation angle of the sensor.
Er-01	Flash memory is damaged or passed its life expectancy.	Please contact our office.
Er-11	Load of the sensing output is short-circuited causing an over-current to flow.	Turn OFF the power and check the load.
Er-21	The semiconductor laser is damaged or passed its life expectancy.	Please contact our office.
Er-31	• When zero set is set, the measurement is not performed normally. • Since the display setting is set to "Offset", the zero set function can not be used.	• Confirm that the sensing distance is within the specification range. • Set the display to any setting except "Offset."
Er-41	During teaching, the measurement is not performed normally.	Confirm that the sensing distance is within the specification range.
Er-90 Er-91 Er-92 Er-93	System error	Please contact our office.

## 15 SPECIFICATIONS

Type	Measurement center 30mm type	Measurement center 50mm type	Measurement center 100mm type	Measurement center 200mm type	Measurement center 400mm type
Model No.	NPN output PNP output	HG-C1030 HG-C1030-P	HG-C1050 HG-C1050-P	HG-C1100 HG-C1200-P	HG-C1400 HG-C1400-P
Measurement center distance	30mm	50mm	100mm	200mm	400mm
Measurement range	±5mm	±15mm	±35mm	±80mm	±200mm
Repeatability	10µm	30µm	70µm	200µm	300µm (measurement distance 200 to 400mm) 800µm (measurement distance 400 to 600mm)
Linearity	±0.1%F.S.			±0.2%F.S.	
Temperature characteristic	0.03%F.S./°C				
Light source	Red semiconductor laser Class 2 [JIS / IEC / GB / FDA (Note 2)] Max. output: 1mW, Emission peak wavelength: 655nm				
Beam diameter (Note 3)	Approx. ø50µm	Approx. ø70µm	Approx. ø120µm	Approx. ø300µm	Approx. ø500µm
Supply voltage	12 to 24V DC ±10%, Ripple P-P 10% or less				
Power consumption	40mA or less (at 24V DC supply voltage), 65mA or less (at 12V DC supply voltage)				
Control output	<NPN output type> NPN open-collector transistor • Maximum sink current: 50mA • Applied voltage: 30V DC or less (Between control output to 0V) • Residual voltage: 1.5V or less (At 50mA sink current) • Leakage current: 0.1 mA or less		<PNP output type> PNP open-collector transistor • Maximum source current: 50mA • Applied voltage: 30V DC or less (Between control output to +V) • Residual voltage: 1.5V or less (At 50mA source current) • Leakage current: 0.1 mA or less		
Output operation	Switchable either Light-ON or Dark-ON				
Short-circuit protection	Incorporated (Auto reset type)				
Analog output	Analog voltage output	• Output range: 0 to +5V (at alarm: +5.2V) • Output impedance: 100Ω			
	Analog current output	• Output range: 4 to 20mA (at alarm: 0mA) • Load impedance: 300Ω or less			
Response time	Switchable between 1.5ms / 5ms / 10ms				
External input	<NPN output type> NPN non-contact input • Input conditions Invalid: +8 to +V DC or Open Valid: 0 to +1.2V DC • Input impedance: Approx. 10kΩ		<PNP output type> PNP non-contact input • Input conditions Invalid: 0 to +0.6V DC or Open Valid: +4 to +V DC • Input impedance: Approx. 10kΩ		
Protection	IP67 (IEC)				
Degree of pollution	2				
Ambient temperature	-10 to +45°C (No dew condensation or icing allowed), Storage: -20 to +60°C				
Ambient humidity	35 to 85% RH, Storage: 35 to 85% RH				
Ambient illumination	Incandescent lamp: Acceptance surface illumination 3,000lx or less				
Operating altitude	2,000m or less				
Cable	0.2mm <sup>2</sup> 5-core composite cable, 2m long				
Material	Enclosure: Aluminum die-cast, Front cover: Acrylic				
Weight	Approx. 35g (without cable), approx. 85g (including cable)				

- Notes: 1) Supply voltage: 24V DC, ambient temperature: +20°C, response time: 10ms, and analog output value of measurement center distance are used for unspecified measurement conditions. The subject is white ceramics.  
2) This is based on the FDA Standard, according to Laser Notice No. 50 of the FDA Standard.  
3) This is the size in the measurement center distance. These values were defined by using 1/e<sup>2</sup> (approx. 13.5%) of the center light intensity. Due to leak light outside the specified area, the reflectance around the detecting point may be higher than at the point and this may affect the measurement value.

## Panasonic Industrial Devices SUNX Co., Ltd.

<http://panasonic.net/id/pidsx/global>

### Overseas Sales Division (Head Office)

2431-1 Ushiyama-cho, Kasugai-shi, Aichi, 486-0901, Japan  
Phone: +81-568-33-7861 FAX: +81-568-33-8591

For sales network, please visit our website.

PRINTED IN CHINA

© Panasonic Industrial Devices SUNX Co., Ltd. 2017