

Ultra High-Speed, High-Accuracy
Laser Displacement Sensor

HL-C2 Series

User's Manual

Preface

Thank you for purchasing Ultra High-Speed, High-Accuracy Laser Displacement Sensor “HL-C2 Series”.

To fully use this product safely and properly, please read this manual carefully. Please check our website (<https://panasonic.net/id/pidsx/global>) about new info of the product and new version of the user’s manual.



■ Note



1. Please notice that illustrations in this USER’S MANUAL might be little different from the actual product.
2. Contents of this USER’S MANUAL will be changed without notice due to improvements.
3. This USER’S MANUAL and software must not be partially or totally copied or reprinted.
4. If there are any questions, mistakes, paging disorder, or missing pages in this USER’S MANUAL, please contact our sales office nearest you.
5. We have no responsibility of any results of operations regardless of the above.

■ Symbol Indications

This USER’S MANUAL uses symbols to indicate safety precautions, instructions, and reference.

Before reading this USER’S MANUAL, fully understand the meanings of these indications.

 WARNING	“WARNING” indicates the possibility that death or serious injury could result if a handling error occurs.
 CAUTION	“CAUTION” indicates the possibility that the user could be injured or property could be damaged if a handling error occurs.

 CHECK	“CHECK” indicates any instructions or precautions for using the system.
 REFERENCE	“REFERENCE” indicates any hints for operation, detail explanations, or references.
 TECHNIQUE	“TECHNIQUE” indicates useful conditions or techniques (know-how) for operation of the system.

Whole USER'S MANUAL Construction

The HL-C2 Series is prepared for the following user's manuals.
Read them as necessary.

HL-C2 Series USER'S MANUAL (PDF)

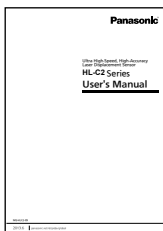

This manual

This manual describes cautions for using HL-C2 Series, and installation method, operation method, function details, specifications, maintenance and inspection method of system components (controller, sensor head).

HL-C2 Series USER'S MANUAL: RS-232C Communication Control (PDF)

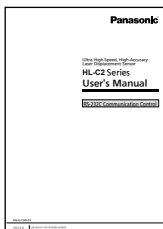

The manual describes various commands for controlling the system by PLC or PC using RS-232C communication. Please read this manual before an evaluation test for system configuration or programming. Please read "HL-C2 Series USER'S MANUAL" for functional details of the system.

HL-C2 Series USER'S MANUAL: USB Communication Control (PDF)

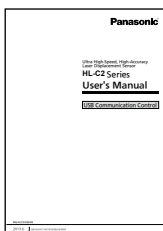

The manual describes API for controlling the system by PLC or PC using USB communication. Please read this manual before an evaluation test for system configuration or programming. Please read "HL-C2 Series USER'S MANUAL" for functional details of the system.

HL-C2 Series USER'S MANUAL: Ethernet Communication Control (PDF)

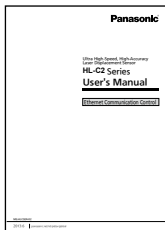

This manual explains various settings to acquire measurement information of the HL-C2 system by PLC using Ethernet communication.

For detailed explanation concerning the system's functions, precautions for use, etc., refer to the separate "HL-C2 Series USER'S MANUAL".

■ USER'S MANUAL for Intelligent Monitor AiM

The Intelligent Monitor AiM, which contains various useful functions in addition to the compact programmable display, is available when developing PC-based system.

HL-C2 Series USER'S MANUAL: Intelligent Monitor AiM (PDF)

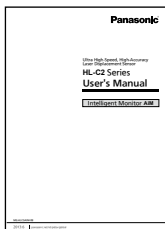

This manual is included as a PDF file in the Intelligent Monitor AiM, which can be downloaded on our Internet website.

This manual describes installation method, operation method, functional details and error messages of the software.

It also describes an evaluation analysis of HL-C2 Series or use of buffering function and received light intensity waveform display function, which are useful for optimum system setting.

Manual Construction

Preface	Preface This chapter provides cautions for safe and correct operation of the product. Be sure to read this chapter.
1	Prior to Use This chapter explains the configuration, installation, and connection of the system (Controller, Sensor head, and Intelligent monitor AiM).
2	I/O Terminal This chapter explains I/O terminal blocks on the controller.
3	Programmable Display Operation This chapter describes the operation method of compact programmable display.
4	Explanation of Functions This chapter describes various functions of the system.
5	Communication Control This chapter explains control method of system by RS-232C/USB/Ethernet communication.
6	Maintenance and Service This chapter explains the maintenance and service of the system.
7	Troubleshooting This chapter explains corrective actions against abnormal state. Read this chapter if failures are suspected.
8	Specification This chapter describes the specifications of system components (controller, and sensor head).
Appendix	Appendix This chapter provides index and revision history of this manual.

1

2

3

4

5

6

7

8

Apx

Contents

Whole USER'S MANUAL Construction	1
■ USER'S MANUAL for Intelligent Monitor AiM	2
Manual Construction	3
Contents	4
Safety Precautions	7
Correct Handling	8
Installation Environment	8
■ Do not install the product in the following conditions	8
Use Environment	8
■ Ambient Temperature, Humidity and Illuminance	8
■ Power Supply Voltage	9
■ Environment	9
Protective Structure	9
Warming Up Time	10
Measures to Noise	10
Insulation Resistance and Voltage Resistance	10
Power Supply	11
■ Power Supply	11
■ Power Supply Sequence for Controller	11
Instantaneous Power Failure	11
Grounding	12
■ Ground the device when noise influence is large	12
■ Use an exclusive ground	12
■ Precautions for positive ground environment	13
Installation	14
■ Controller	14
■ Wire Connections and Connectors	14
■ Cable Extension	15
Cautions on Handling Laser Light	16
JIS/IEC/GB/KS	16
■ Semiconductor laser is used as the light source of sensor	16
(*1) HL-C201A□-SP3□: 0.3mW	16
■ Cautions	16
■ Warning Label	17
CE	23
■ CE Compliant Condition	23
FDA	24
■ Export to US	24
■ FDA-compliant Product	24
■ Classification	24
*1 10mm type is classified as Laser Class I, Laser Notice No.50. ■ Labeling	24

■ Labeling	25
■ Beam Attenuator	26
■ FDA Standard	27
Remote Interlock	28
Export Regulations by Japanese Government	29
■ Compliance with Export Regulations by Japanese Government	29
■ Specification of Export Uncontrolled Product	30
■ Functional Restriction	30

1 Prior to Use 1-1

1-1 System Configuration	1-2
1-1-1 System Configuration	1-2
1-1-2 System Components & Accessories List	1-3
■ Controller Accessories	1-3
■ Sensor Head Accessories	1-4
■ ND Filter Unit (Optional)	1-4
■ Extension Cable for Sensor Head (Optional)	1-4
■ Extension Cable for Sensor Head (Optional)	1-5
■ Compact programmable display (Optional)	1-5
■ Connection cable for compact programmable display (3m) (Optional)	1-6
■ Intelligent Monitor AiM	1-6
■ Ethernet Communication Setting Tool	1-6
1-2 Part Names and Functions	1-7
1-2-1 Controller	1-7
1-2-2 Sensor Head	1-9
1-3 Installation Method	1-10
1-3-1 Controller	1-10
■ Installation by Using DIN Rail	1-10
■ Installation by Using Screws	1-10
1-3-2 Sensor Head	1-11
■ Installation Direction of Sensor Head	1-11
■ Mounting ND Filter	1-14
1-4 Connection	1-15
1-4-1 Connection Method of Power Supply	1-15
1-4-2 Connection Method of Terminal Block	1-15
■ Model Number of Terminal Blocks	1-16
■ Wiring Method	1-16

1-4-3 Connection of Intelligent Monitor	
AiM (PC).....	1-17
■ Connection.....	1-17
2 I/O Terminal Block	2-1
2-1 Functions and Arrangements of I/O Terminal Block.....	2-2
2-2 I/O Circuit	2-4
■ NPN Type.....	2-4
■ PNP Type.....	2-5
2-3 Interlock Circuit	2-6
■ NPN Type.....	2-6
■ PNP Type.....	2-6
2-4 Analog Output Circuit	2-7
2-5 Timing Chart	2-8
3 Programmable Display Operation	3-1
3-1 Operation Screens	3-2
■ Screens.....	3-2
■ Shift Screen Levels.....	3-3
■ Select Variables from among Alternatives.....	3-3
■ Enter Value.....	3-4
3-2 Basic Operation.....	3-6
3-2-1 First Measurement.....	3-6
Initial power-on.....	3-6
Basic setting.....	3-6
Position adjustment of sensor head.....	3-7
Initialization.....	3-7
Save settings.....	3-7
Thickness measurement.....	3-8
Thickness measurement: glass material.....	3-9
3-3 Screen Transition Diagram.....	3-10
■ Screen Flow.....	3-10
3-3-1 Display Waveform of Received Light Intensity.....	3-14
3-3-2 Received Light Intensity at Peak	3-14
4 Explanation of Functions	4-1
4-1 Data Flow	4-2
4-2 Classification of Function.....	4-3
4-3 Function List & Initial Values	4-3
4-3-1 Head Setting	4-7
■ Installation Mode.....	4-7
■ Measurement Mode.....	4-8
■ Emission Adjustment.....	4-10
■ Emission Adjustment Area.....	4-11
■ Emitted Light Intensity Search.....	4-12
■ Emitted Light Intensity Search.....	4-13
■ Alarm Delay Times.....	4-14
■ Measurement Surface Reference.....	4-15
■ Measuring Range.....	4-16
■ Laser Control.....	4-18
■ Calibration.....	4-19
■ Peak Recognition Sensitivity.....	4-21
■ Median Filter.....	4-22
4-3-2 OUT Setting.....	4-23
■ Output Selection.....	4-23
■ Transparent Object.....	4-25
■ Refractive Index Calculation.....	4-27
■ Refractive Index.....	4-29
■ Zero Set.....	4-31
■ Timing.....	4-33
■ Reset.....	4-34
■ Hold.....	4-35
■ Analysis Mode.....	4-36
■ Filter Operation.....	4-37
■ Operation Coefficient.....	4-39
■ Offset.....	4-40
■ Upper/Lower Limit Value of Judgment Output.....	4-41
■ Upper/Lower Hysteresis of Judgment Output.....	4-43
■ Analog Scaling.....	4-45
■ Analog Output at Alarm.....	4-48
■ Analog Output at Data Unfixed.....	4-49
■ Digital Output at Alarm.....	4-50
■ Alarm Output Delay.....	4-51
■ Digit Number of Measurement Value.....	4-52
4-3-3 Common Setting.....	4-53
■ Sampling Period.....	4-53
■ Terminal Input Control.....	4-55
■ Chattering Prevention of Terminal Input.....	4-56
■ Judgment Output Off Delay.....	4-57
■ Interference Prevention.....	4-58
4-3-4 System Setting.....	4-59
■ Display Update Cycle of Measurement Value.....	4-59
■ Change Indication Unit.....	4-61
■ Output Setting Copy.....	4-62
■ Priority Setting of Memory Change.....	4-63
■ Memory Change.....	4-64
■ Memory Copy.....	4-65
■ Initialization.....	4-66
■ Save.....	4-68
■ Communication: COM Port.....	4-69
■ RS-232C Output.....	4-70
■ Console Setting.....	4-72
4-3-5 Buffering Setting.....	4-75
■ Data Buffering Operation.....	4-76
■ Buffering Operation.....	4-77

- Self-stop 4-77
- Buffering Mode 4-77
- Buffering Type 4-79
- Buffering Rate 4-79
- Accumulation Amount 4-79
- Trigger Conditions 4-80
- Trigger Delay 4-81
- Trigger Point 4-81
- Sample Trigger Accumulation Amount 4-81
- Status Readout 4-82
- Final Data Point 4-82
- Trigger Counter Readout 4-82
- Data Read 4-83
- 4-4 Supplemental Explanation 4-84
- 4-4-1 Alarm Setting and Outputs 4-84
- 4-4-2 Conditions When Output Data become Unfixed 4-85
- 4-4-3 Memory Save and Terminal Setting 4-88
 - Storable Functions in Memory 4-88
 - Memory Change Procedure by External Input Terminal 4-88
 - External Input Terminal Setting 4-89
- 5 External Communication Control** 5-1
- 5-1 Communication Control by RS-232C 5-2
- 5-1-1 Specifications 5-2
 - Communication Specifications 5-2
 - Pin Arrangement 5-2
 - Connecting Example with External Device 5-3
 - Communication Procedures 5-4
 - Change of Communication Conditions 5-4
- 5-1-2 Type and Format of Commands 5-5
 - Data Transmission/Reception 5-5
 - Command Classification 5-7
 - Request Communication Data Format 5-8
 - Response Communication Data Format 5-9
 - BCC 5-13
- 5-1-3 Command List 5-14
- 5-2 USB Communication Control 5-24
 - Operating Environment 5-25
 - Change RS-232C Communication Conditions 5-25
 - Sample program 5-25
- 5-3 Ethernet Communication Control 5-26
 - Specifications of Ethernet Block 5-26

- 6 Maintenance and Inspection** 6-1
- 6-1 Maintenance 6-2
 - Maintenance Instructions 6-2
- 6-2 Inspection 6-2
 - Major Inspection Items 6-2
- 7 Troubleshooting** 7-1
- 7-1 Corrective Actions 7-2
- 7-2 Lock 7-7
- 7-3 Initialization 7-7
- 8 Specifications** 8-1
- 8-1 Controller Specifications 8-2
- 8-2 Sensor Head Specifications 8-8
 - Sensor Head Model 8-8
 - CHECK in specifications 8-9
 - List of products which have attained the Korea's S-mark certification 8-9
- 8-3 ND Filter Specifications 8-36
- 8-4 Outside Dimension 8-37
 - Controller 8-37
 - Sensor Head 8-39
 - <FDA-compliant sensor head> 8-46
 - ND Filter (HL-C2F01) 8-48
- 8-5 Characteristics 8-49
 - Beam Diameter 8-49
 - Mutual Interference Area 8-53
 - Output Characteristics and Measurement Range Indicator 8-56
- Appendix** 1
- 1 Index 2
 - Revision history 6

Safety Precautions

This product is intended to detect the objects and does not have the control function to ensure safety such as accident prevention.

Do not use the product as a sensing device to protect human body.

Please use the products that comply with local laws and standards for human body protection specified by e.g., OSHA, ANSI and IEC.

Please read this manual carefully before using the product and use it correctly.

WARNING

- Install a fail-safe device when the product is used for the purpose that has a possibility of physical injury or serious extended damage.
- Do not use the product in the atmosphere of flammable gas, to prevent explosion.
- The product was developed and manufactured for industrial use.

CAUTION

- Use the product within specifications.
Abnormal heat or smoke generation may occur.
- Do not disassemble or remodel the product. Electrical shock or smoke generation may occur.
- Connect the electric wire securely with the terminal screws.
Imperfect connection may cause abnormal heat or smoke generation.
- Do not touch the terminal during energization of the product, to prevent electrical shock.

Correct Handling

Note the following points when installing and using HL-C2 Series.

Installation Environment

- Do not install the product in the following conditions.
 - Where the ambient temperature, ambient humidity or ambient illuminance of beam receiving surface is beyond the range of specifications (→ Refer to “Use Environment”).
 - Where dew condensation occurs due to rapid temperature change
 - In an atmosphere of corrosive gas or flammable gas
 - Where covered or filled with dust, iron powder and salt
 - In an atmosphere which is likely to be exposed to organic solvent such as benzene, thinner or alcohol, or to strong alkaline materials such as ammonia or sodium hydroxide
 - Where heavy vibration or impact is applied
 - Where direct sunlight is received
 - Where water, oil or chemicals splashes
 - Where load is applied to the product

Use Environment

■ Ambient Temperature, Humidity and Illuminance

Ambient temperature

- Use the product with the temperature specification ranges (→ Chapter 8 “Specifications”).

Sensor head : 0 to 45°C

Controller : 0 to 50°C

Compact programmable display : 0 to 50°C

Store the product with the following specification ranges.

Sensor head : -20 to 70°C

Controller : -20 to 70°C

Compact programmable display : -20 to 60°C

- The life of the semiconductor laser depends on the ambient temperature during use. When using the product near a heat source, take measures to keep the ambient temperature of the sensor head as lower as possible. Mount the sensor on a device having good heat radiation because the sensor itself also generates heat.

* As for HL-C211□□(-□□), when installing two sensor heads in parallel with a distance of 20mm or less, each sensor head should be mounted on aluminum or iron which surface area is 200cm² or more.

Ambient humidity

Use the sensor within a range of 35 to 85% RH.

Avoid using it in places that may be exposed to dew condensation due to rapid temperature change.

Ambient illuminance of light receiving surface

Use the sensor in locations where illuminance from incandescent lamps is 3,000 lx or less.

■ Power Supply Voltage

The power supply voltage should be within the rated voltage range of 21.6 to 26.4V DC.

■ Environment

- The internal circuit may be broken when the external surge voltage exceeds 500V [$\pm (1.2 \times 50) \mu\text{s}$ unipolar full wave voltage]. If there is danger of external surge voltages exceeding 500V, install a surge absorber between the power supply and input terminal.
- Keep the emitter surface and the receiver surface clean, not to attach light refractors such as water, oil and fingerprints, or light blockers such as dust and dirt. When cleaning these parts, wipe them off using a soft lint-free cloth or lens cleaning paper.
- Install the sensor head at where extraneous light (such as sunlight or light which has the same wavelength as laser beam) do not enter the receiver. If high accuracy is required, install a light shield plate or the like on the sensor head.
- Do not use the product in dusty places or that exposed to flammable or corrosive gases, droplet, direct sunlight, severe vibration or impact.

Protective Structure

- The sensor head has protection against immersion, while the controller and connectors are not structurally dustproof, waterproof, or corrosion-resistant. Do not use the product underwater or in the rain.

Warming Up Time

Allow at least 30 minutes of warming up after turning on the power to ensure the performance of the product.

Measures to Noise

- Install the product as far away as possible from noise source such as high-voltage lines, high-voltage device, power lines, power device, machines which generate a large starting and stopping surge, welding machines and inverter motor.
- Install the product as far away as possible from wireless device that has a transmitter such as amateur radio device.
- The LCD display breaks if excessive static electricity is applied on the panel surface of compact programmable display.
- Do not roll up the sensor cable (bundle in parallel) with other wirings. Keep it at least 100mm away from other wires. Cables should be separated from high voltage and power circuit lines. If it is unavoidable, shield it by running through a conductive material such as grounded electrical conduit.
- For input signal lines and output signal lines, run them separately, not rolled up with the power line and power supply line. Keep them at least 100 mm apart. All signal lines should be connected as short as possible.
- Analog output is affected if a large amount of electrical noise arises in the power supply. In this case, use a noise filter or a noise dampened transformer.
- For signal lines for RS-232C or for I/O terminals, use shielded cables and connect the shielding wire to the frame ground (F.G.) to reduce electric noise.
- Analog outputs is likely to be influenced by noise, especially by external noise. Use shielded wires and wire them as short as possible.
- Use an exclusive class D frame ground and avoid sharing the ground with other devices. This may produce an opposite effect.

Insulation Resistance and Voltage Resistance

Do not conduct insulation resistance tests and voltage resistance tests among the power supply, I/O signals, metal parts of the controller and sensor head.

Power Supply

■ Power Supply

- Select a power supply with a ripple 0.5V or less (P-P) and a current capacity 2A or more.
- When using a commercial switching regulator, be sure to ground the frame ground (F.G.) terminal to avoid the influence of high frequency noise.
- When using a transformer in the power supply, be sure to use an insulated transformer. The product or the power supply may be damaged if an auto transformer is used.
- Use an insulated power supply that incorporates a protective circuit to protect against abnormal voltages from the power line.
- When using a power supply that does not incorporate a protective circuit, be sure to supply power through a protective element such as a fuse.

■ Power Supply Sequence for Controller

- Arrange the power supply sequence so the controller turns off prior to the I/O power.
- If the I/O power turns off prior to the controller, the controller detects the change in level of input signals and this may cause wrong operation.
- Leave an interval for at least 10 seconds between turning off the controller and turning on the power again.
- It takes about 40 to 50 seconds from power-on to operating state (start up completed), depending on the settings saved. No outputs are determined during startup. Do not output anything during the period.
- During startup, -10.8V of analog voltage and -5mA of analog current are output.
- Do not turn off the power while saving the settings. In the worst case, the system of controller is destroyed and may fail to restart.

Instantaneous Power Failure

If an instantaneous power failure occurs, the system operates continuously, or goes to the same state as power-on state, depending on the duration of power failure. Do not use the system in the environment where an instantaneous power failure occurs.

Grounding

■ Ground the device when noise influence is large

- Under normal use, the product has sufficient noise resistance. In an environment with particularly high noise levels, however, ground it securely.

■ Use an exclusive ground

- Use wires of 1.5 mm² or more and establish a class D ground with a ground resistance of 100Ω or less.
- Make the grounding point as close to the controller as possible, keeping the ground wire distance short.
- Use an exclusive ground. Sharing the ground with other devices may produce an opposite effect.
- The connector housing for the sensor head case and sensor cable is connected electrically to the frame ground (F.G.) terminal of the controller terminal through the sensor cable.

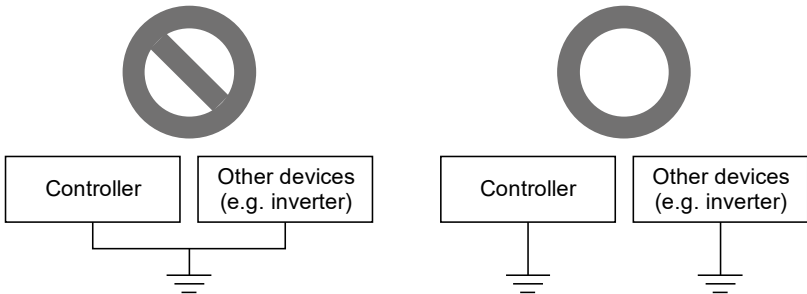

■ Precautions for positive ground environment

The GND terminals of 24VDC (-) and USB port, SG of RS-232C, and COMMON terminal (-) of the input / output circuit are connected inside the HL-C2. The FG terminal, USB port connector shell, RS-232C connector shell and Ethernet connector shell are also connected inside the HL-C2. Make sure that there is no potential difference from externally connected devices such as a PC and PLC.

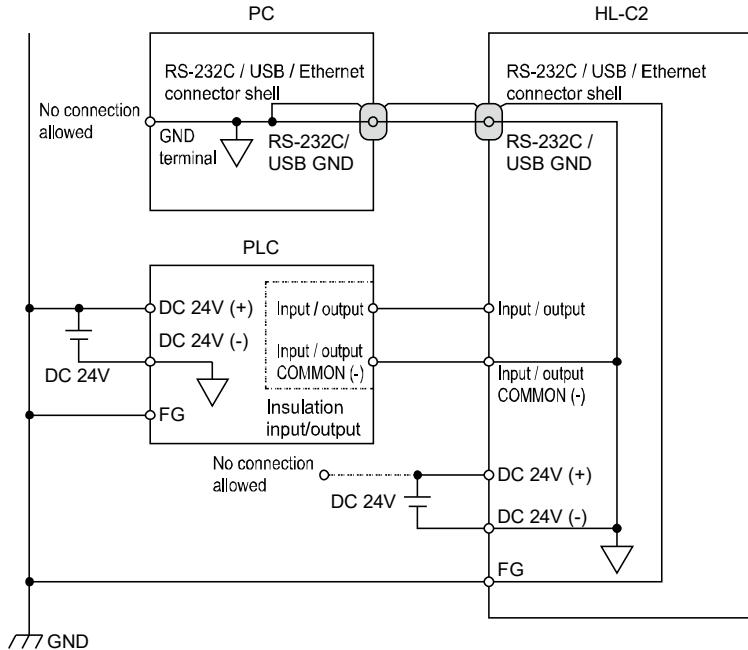

If the HL-C2 is used in a positive-grounding environment, power supply (24VDC) can become short-circuited via the GND terminal of PC or USB, thus resulting in a malfunction.

- Do not ground the positive (+) terminal of the HL-C2.
- When grounding the positive side of the power supply (24V DC) to the equipment, use a separate power supply (24V DC) for the HL-C2 and insulate the HL-C2.

Installation

■ Controller

- Install the controller unit according to “1-3 Installation Method”, assuring plenty of space around it. If it is installed in a manner other than specified, failures may occur due to temperature rise.
- If the controller is mounted internally on the place where air circulation is blocked such as in a control board, the ambient temperature will rise due to heat generated by the controller. In such case, forced cooling is required.
- Vent holes for heat radiation are provided at the top and bottom of controller unit. Provide adequate space for heat radiation, not to block the holes.

■ Wire Connections and Connectors

- Connect all wirings securely according to the explanations for I/O circuit and description on the unit.
- Turn off the power of controller before connecting or disconnecting the connectors.
- When connecting or disconnecting the connectors, be sure to hold the connector area not to apply extra force to the cable.
- Be careful not to touch terminals or to let foreign objects get in the connector after disconnecting connectors.
- Be careful not to apply force to around the connector of sensor head cable and extension cable. Do not bend the cables near connectors, which causes disconnection of the cable.
- This product is a precision machine. Therefore, fix wiring so that the wiring load is not applied to the product. For cable sections that are not fixed, use cable protection material not to damage the cable.
- Do not pull the cable with a force of 29.4 N or more.
- When bending the cable, bend it at least 20 mm away from the cable lead-out part with the minimum bending radius of 30 mm or more.
- When the sensor head is moved around while in use, the cable in the moving part may be damaged. Therefore, use an extension cable for the moving part and, when the extension cable is damaged, immediately replace it. Otherwise, it may result in failure.

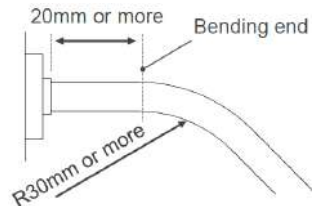

■ Cable Extension

- Use only one extension cable for connection between one sensor head and a controller.
- When the sensor head part is moved around while in use, fix the extension cable at a position 100 mm away from the mobile end.

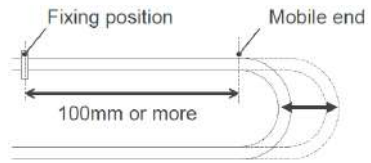

Cautions on Handling Laser Light

JIS/IEC/GB/KS

■ Semiconductor laser is used as the light source of sensor

The laser is classified based on JIS (JIS C 6802:2014) and IEC (IEC 60825-1:2014), GB (GB 7247.1:2012), KS (KS C IEC 60825-1:2013) standards.

Class	Max. output	Wavelength	Model No.
1	0.1mW (*1)	658nm	HL-C201A□(-□)
2	1mW	658nm	HL-C203B□(-MK), HL-C205B□(-MK), HL-C208B□(-MK), HL-C211B□(-MK), HL-C235BE(-MK)
3R	5mW	658nm	HL-C205C□(-MK), HL-C208C□(-MK), HL-C211C□(-MK), HL-C235CE(-MK), HL-C235CE-W(MK)

(*1) HL-C201A□-SP3□: 0.3mW

■ Cautions

- 1) Be careful not to directly watch the laser beam or its reflected light from a mirror surface.
- 2) Install the sensor so the laser beam comes higher or lower than eye level in order not to watch the beam directly during operation.
Laser safety distance (Nominal Ocular Distance: NOHD) is approx. 0.4m for HL-C203B□(-MK) and HL-C205□(-MK), is approx. 0.5m for HL-C208□(-MK) and HL-C211□(-MK), is approx. 1.4m for HL-C235BE(-MK) / HL-C235CE(-MK), HL-C235CE-W(MK). The laser beam must be terminated at the end of its path by a diffuse reflector or an absorber.
- 3) Laser beam emission can be stopped by using the laser control input terminal. (→ “2-1 Functions and Arrangement of I/O Terminal Block”)
 - * Use the interlock control input terminal when using as an emergency stop circuit for safety. Release the short circuit by short bar to stop laser emission.
- 4) Please contact Panasonic Industrial Devices SUNX if the system breaks down. Laser radiation is not automatically stopped during disassembling the sensor head. The users therefore may be exposed to laser beam in disassembling the sensor head.
- 5) Do not use the system in the manner other than specified in this USER’S MANUAL.

 CAUTION	You may be exposed to hazardous laser radiation if the device is controlled or adjusted in procedures not specified in this manual.
--	---

- 6) Read the descriptions of the warning label carefully before use.
The warning label is affixed to the side of the sensor head. The Japanese and English warning labels are packed with the sensor. Use them as needed.

■ Warning Label

● 10mm type (HL-C201A)

In Japanese / English / Korean



In Chinese (E type only)



<Label position>

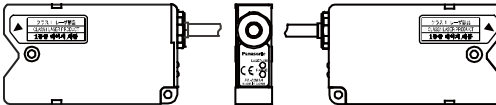

● 30mm type (HL-C203B)

In Japanese / English / Korean



In Chinese (E type only)



<Label position>

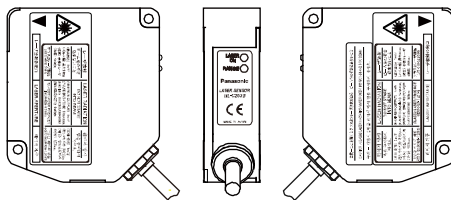

● 5mm type (HL-C205B)

In Japanese / English / Korean

	レーザー放射 直射光線を受 込まないこと	LASER RADIATION DO NOT STARE INTO BEAM	레이저 빛 직접 조사 받지 마세요
	最大出力: 5mW 赤外線: 10mW 波長: 650nm 媒体: 半導体レーザー 2類レーザー製品 GB7247.1 2012	MAXIMUM OUTPUT: 5mW IR LASER RADIATION: 10mW WAVELENGTH: 650nm CLASS II LASER PRODUCT REGULATORY CLASS: II	최대 출력: 5mW 적외선 출력: 10mW 파장: 650nm 매체: 반도체 레이저 2급 레이저 제품 GB7247.1 2012
	レーザー放射の出口 LASER APERTURE		레이저 개구 LASER APERTURE

注意: 二重線(ダブルライン)レーザー製品は、レーザー放射を直接目に当てないこと。
CAUTION: CLASS II LASER PRODUCT. DO NOT STARE INTO LASER BEAM.
주의: 이중선(두중선) 레이저 제품은 레이저 빛을 직접 눈으로 피하지 마세요.

	레이저 방사 직접 조사 받지 마세요	LASER RADIATION DO NOT STARE INTO BEAM	레이저放射 직접 조사 받지 마세요
	최대 출력: 5mW 적외선 출력: 10mW 파장: 650nm 매체: 반도체 레이저 2급 레이저 제품 GB7247.1 2012	MAXIMUM OUTPUT: 5mW IR LASER RADIATION: 10mW WAVELENGTH: 650nm CLASS II LASER PRODUCT REGULATORY CLASS: II	최대 출력: 5mW 적외선 출력: 10mW 파장: 650nm 매체: 반도체 레이저 2급 레이저 제품 GB7247.1 2012
	레이저 개구 LASER APERTURE		레이저放射의 출구 LASER APERTURE

In Chinese (E type only)

	激光辐射 勿直视光束	注意 打靶时避免激光直射 勿靠近靶
	最大输出: 5mW 红外: 10mW 媒体: 半导体激光 波长: 650nm 2类激光产品 GB7247.1 2012	
	激光窗口	

	注意 打靶时避免激光直射 勿靠近靶	激光辐射 勿直视光束
	最大输出: 5mW 红外: 10mW 媒体: 半导体激光 波长: 650nm 2类激光产品 GB7247.1 2012	
	激光窗口	

<Label position>

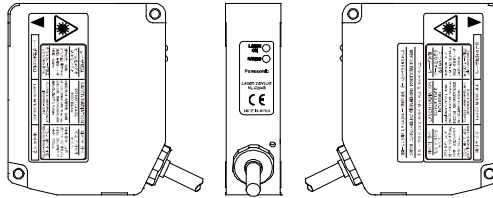

● 50mm type (HL-C205C)

In Japanese / English / Korean

	レーザー放射 直射光線を受 込まないこと	LASER RADIATION AVOID DIRECT EYE EXPOSURE	레이저 빛 직접 조사 받지 마세요
	最大出力: 5mW 赤外線: 10mW 波長: 650nm 媒体: 半導体レーザー 3R類レーザー製品 GB7247.1 2012	MAXIMUM OUTPUT: 5mW IR LASER RADIATION: 10mW WAVELENGTH: 650nm CLASS III R LASER PRODUCT REGULATORY CLASS: III R	최대 출력: 5mW 적외선 출력: 10mW 파장: 650nm 매체: 반도체 레이저 3R급 레이저 제품 GB7247.1 2012
	レーザー放射の出口 LASER APERTURE		레이저 개구 LASER APERTURE

注意: 二重線(ダブルライン)レーザー製品は、レーザー放射を直接目に当てないこと。
CAUTION: CLASS III R LASER PRODUCT. AVOID DIRECT EYE EXPOSURE.
주의: 이중선(두중선) 레이저 제품은 레이저 빛을 직접 눈으로 피하지 마세요.

	레이저 방사 직접 조사 받지 마세요	LASER RADIATION AVOID DIRECT EYE EXPOSURE	레이저放射 직접 조사 받지 마세요
	최대 출력: 5mW 적외선 출력: 10mW 파장: 650nm 매체: 반도체 레이저 3R급 레이저 제품 GB7247.1 2012	MAXIMUM OUTPUT: 5mW IR LASER RADIATION: 10mW WAVELENGTH: 650nm CLASS III R LASER PRODUCT REGULATORY CLASS: III R	최대 출력: 5mW 적외선 출력: 10mW 파장: 650nm 매체: 반도체 레이저 3R급 레이저 제품 GB7247.1 2012
	레이저 개구 LASER APERTURE		레이저放射의 출구 LASER APERTURE

In Chinese (E type only)

	激光辐射 避免眼睛受到直接照射	注意 打靶时避免激光直射 避免眼睛受到直接照射
	最大输出: 5mW 红外: 10mW 媒体: 半导体激光 波长: 650nm 3R类激光产品 GB7247.1 2012	
	激光窗口	

	注意 打靶时避免激光直射 避免眼睛受到直接照射	激光辐射 避免眼睛受到直接照射
	最大输出: 5mW 红外: 10mW 媒体: 半导体激光 波长: 650nm 3R类激光产品 GB7247.1 2012	
	激光窗口	

<Label position>

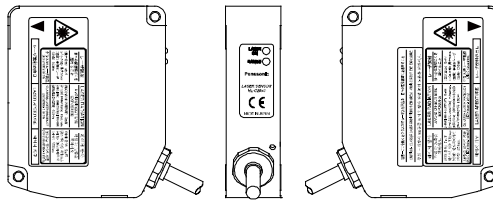

● 85mm type (HL-C208B)

In Japanese / English / Korean

	<p>レーザー放射 レーザー放射線に 注意してください</p> <p>最大出力: 1mW 波長: 最大10nm 媒体: 半導体発光 波長: 658nm 2類レーザー製品 (GB7247.1 2012)</p>	<p>LASER RADIATION DO NOT STARE INTO BEAM</p> <p>MAXIMUM OUTPUT: 1mW WAVELENGTH: 10nm max MEDIUM: SEMICONDUCTOR EMITTING WAVELENGTH: 658nm CLASS II LASER PRODUCT (GB7247.1 2012)</p>	<p>레이저 방사 레이저 방사선 에 주의하십시오</p> <p>최대 출력: 1mW 파장: 최대 10nm 매체: 반도체 발광 파장: 658nm 2류 레이저 제품 (GB7247.1 2012)</p>
	<p>レーザー放射の出口 LASER APERTURE</p>	<p>레이저 개구</p>	

<p>警告—この装置はクラス2のレーザー放射製品に分類されています CAUTION—CLASS II LASER PRODUCT—DO NOT STARE INTO BEAM 중요—레이저기 또는 레이저 광선으로부터 눈을 보호하십시오</p>			
	<p>레이저 방사 레이저 방사선 에 주의하십시오</p> <p>최대 출력: 1mW 파장: 최대 10nm 매체: 반도체 발광 파장: 658nm 2류 레이저 제품 (GB7247.1 2012)</p>	<p>LASER RADIATION DO NOT STARE INTO BEAM</p> <p>MAXIMUM OUTPUT: 1mW WAVELENGTH: 10nm max MEDIUM: SEMICONDUCTOR EMITTING WAVELENGTH: 658nm CLASS II LASER PRODUCT (GB7247.1 2012)</p>	<p>レーザー放射 レーザー放射線 に注意してください</p> <p>最大出力: 1mW 波長: 最大10nm 媒体: 半導体発光 波長: 658nm 2類レーザー製品 (GB7247.1 2012)</p>
	<p>레이저 개구 LASER APERTURE</p>		<p>レーザー放射の出口</p>

In Chinese (E type only)

	<p>激光辐射 勿直视光束</p> <p>最大输出功率: 1mW 波长: 最大10nm 媒体: 半导体激光 波长: 658nm 2类激光产品 GB7247.1 2012</p>	<p>注意 打开前请勿直视光束 请勿直视光束</p>
	<p>激光窗口</p>	

<p>注意 打开前请勿直视光束 请勿直视光束</p>	<p>激光辐射 勿直视光束</p> <p>最大输出功率: 1mW 波长: 最大10nm 媒体: 半导体激光 波长: 658nm 2类激光产品 GB7247.1 2012</p>	
	<p>激光窗口</p>	

<Label position>

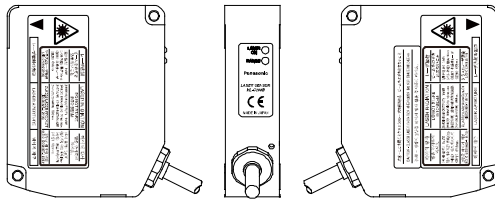

● 85mm type (HL-C208C)

In Japanese / English / Korean

	<p>レーザー放射 目の危険なレーザー 放射線に注意してください</p> <p>最大出力: 5mW 波長: 最大10nm 媒体: 半導体発光 波長: 658nm 3類レーザー製品 (GB7247.1 2012)</p>	<p>LASER RADIATION AVOID DIRECT EYE EXPOSURE</p> <p>MAXIMUM OUTPUT: 5mW PULSE DURATION: 10ns max WAVELENGTH: 10nm max EMITTING WAVELENGTH: 658nm CLASS III LASER PRODUCT (GB7247.1 2012)</p>	<p>레이저 방사 레이저 방사선 에 주의하십시오</p> <p>최대 출력: 5mW 파장: 최대 10nm 매체: 반도체 발광 파장: 658nm 3류 레이저 제품 (GB7247.1 2012)</p>
	<p>レーザー放射の出口 LASER APERTURE</p>	<p>레이저 개구</p>	

<p>警告—この装置はクラス3Rのレーザー放射製品に分類されています CAUTION—CLASS III LASER PRODUCT—AVOID DIRECT EYE EXPOSURE 중요—레이저기 또는 레이저 광선으로부터 눈을 보호하십시오</p>			
	<p>레이저 방사 레이저 방사선 에 주의하십시오</p> <p>최대 출력: 5mW 파장: 최대 10nm 매체: 반도체 발광 파장: 658nm 3류 레이저 제품 (GB7247.1 2012)</p>	<p>LASER RADIATION AVOID DIRECT EYE EXPOSURE</p> <p>MAXIMUM OUTPUT: 5mW PULSE DURATION: 10ns max WAVELENGTH: 10nm max EMITTING WAVELENGTH: 658nm CLASS III LASER PRODUCT (GB7247.1 2012)</p>	<p>レーザー放射 レーザー放射線 に注意してください</p> <p>最大出力: 5mW 波長: 最大10nm 媒体: 半導体発光 波長: 658nm 3類レーザー製品 (GB7247.1 2012)</p>
	<p>레이저 개구 LASER APERTURE</p>		<p>レーザー放射の出口</p>

In Chinese (E type only)

	<p>激光辐射 避免眼睛受到直接照射</p> <p>最大输出功率: 5mW 波长: 最大10nm 媒体: 半导体激光 波长: 658nm 3R类激光产品 GB7247.1 2012</p>	<p>注意 打开前请勿直视光束 请勿直视光束</p>
	<p>激光窗口</p>	

<p>注意 打开前请勿直视光束 请勿直视光束</p>	<p>激光辐射 避免眼睛受到直接照射</p> <p>最大输出功率: 5mW 波长: 最大10nm 媒体: 半导体激光 波长: 658nm 3R类激光产品 GB7247.1 2012</p>	
	<p>激光窗口</p>	

<Label position>

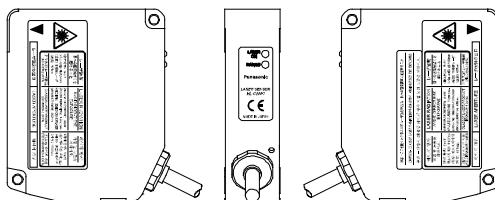

● 110mm type (HL-C211B)

In Japanese / English / Korean

	レーザー放射 目への照射は有害 な場合があります	LASER RADIATION DO NOT STARE INTO BEAM	레이저 빛 직접 눈으로 볼 경우 유해할 수 있습니다
	最大出力: 10mW 赤光: 最大10mW 波長: 658nm 媒体: 半導体レーザー 2類レーザー製品 GB7247.1 2012	MAXIMUM OUTPUT: 10mW RED LASER RADIATION: 10mW max WAVELENGTH: 658nm CLASS II LASER PRODUCT CLASS II LASER PRODUCT (GB7247.1:2012)	레이저 출력 최대: 10mW 색상: 적색 파장: 658nm 매체: 반도체 레이저 2류 레이저 제품 GB7247.1:2012
	レーザー放射の出口 LASER APERTURE		레이저 개구 LASER APERTURE

注意: 二重線(二重線)レーザー製品は、レーザー放射を直接目に当てると、CLASS II LASER RADIATION (EN 60825-1)の110mmタイプに属します。주의: 이중선(二重선) 레이저 제품은 레이저 방사선을 직접 눈으로 피하지 않으면, CLASS II LASER RADIATION (EN 60825-1)의 110mm 유형에 속합니다.

	레이저 방사 직접 눈으로 볼 경우 유해할 수 있습니다	LASER RADIATION DO NOT STARE INTO BEAM	레이저放射 目の直射は有害 な場合があります
	레이저 출력 최대: 10mW 색상: 적색 파장: 658nm 매체: 반도체 레이저 2류 레이저 제품 GB7247.1:2012	MAXIMUM OUTPUT: 10mW RED LASER RADIATION: 10mW max WAVELENGTH: 658nm CLASS II LASER PRODUCT CLASS II LASER PRODUCT (GB7247.1:2012)	레이저 출력 최대: 10mW 색상: 적색 파장: 658nm 매체: 반도체 레이저 2류 레이저 제품 GB7247.1:2012
	레이저 개구 LASER APERTURE		레이저放射の出口 LASER APERTURE

In Chinese (E type only)

	激光辐射 勿直视光束	注意 打靶时避免直视激光 勿直视光束
	最大输出: 10mW 红光: 最大10mW 媒体: 半导体激光 波长: 658nm 2类激光产品 GB7247.1 2012	
	激光窗口 LASER APERTURE	

	激光辐射 勿直视光束	注意 打靶时避免直视激光 勿直视光束
	最大输出: 10mW 红光: 最大10mW 媒体: 半导体激光 波长: 658nm 2类激光产品 GB7247.1 2012	
	激光窗口 LASER APERTURE	

<Label position>

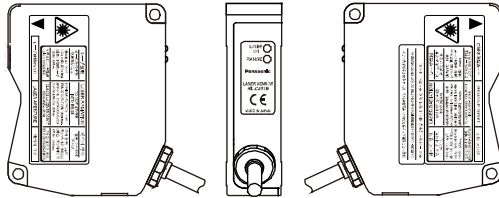

● 110mm type (HL-C211C)

In Japanese / English / Korean

	レーザー放射 目への照射は有害 な場合があります	LASER RADIATION AVOID DIRECT EYE EXPOSURE	레이저 빛 직접 눈으로 볼 경우 유해할 수 있습니다
	最大出力: 5mW 赤光: 最大5mW 波長: 658nm 媒体: 半導体レーザー 3R類レーザー製品 GB7247.1 2012	MAXIMUM OUTPUT: 5mW RED LASER RADIATION: 5mW max WAVELENGTH: 658nm CLASS III R LASER PRODUCT CLASS III R LASER PRODUCT (GB7247.1:2012)	레이저 출력 최대: 5mW 색상: 적색 파장: 658nm 매체: 반도체 레이저 3R류 레이저 제품 GB7247.1:2012
	レーザー放射の出口 LASER APERTURE		레이저 개구 LASER APERTURE

注意: 二重線(二重線)レーザー製品は、レーザー放射を直接目に当てると、CLASS III R LASER RADIATION (EN 60825-1)の110mmタイプに属します。주의: 이중선(二重선) 레이저 제품은 레이저 방사선을 직접 눈으로 피하지 않으면, CLASS III R LASER RADIATION (EN 60825-1)의 110mm 유형에 속합니다.

	레이저 방사 직접 눈으로 볼 경우 유해할 수 있습니다	LASER RADIATION AVOID DIRECT EYE EXPOSURE	레이저放射 目の直射は有害 な場合があります
	레이저 출력 최대: 5mW 색상: 적색 파장: 658nm 매체: 반도체 레이저 3R류 레이저 제품 GB7247.1:2012	MAXIMUM OUTPUT: 5mW RED LASER RADIATION: 5mW max WAVELENGTH: 658nm CLASS III R LASER PRODUCT CLASS III R LASER PRODUCT (GB7247.1:2012)	레이저 출력 최대: 5mW 색상: 적색 파장: 658nm 매체: 반도체 레이저 3R류 레이저 제품 GB7247.1:2012
	레이저 개구 LASER APERTURE		레이저放射の出口 LASER APERTURE

In Chinese (E type only)

	激光辐射 避免眼睛受到直接照射	注意 打靶时避免直视激光 避免眼睛受到直接照射
	最大输出: 5mW 红光: 最大5mW 媒体: 半导体激光 波长: 658nm 3R类激光产品 GB7247.1 2012	
	激光窗口 LASER APERTURE	

	激光辐射 避免眼睛受到直接照射	注意 打靶时避免直视激光 避免眼睛受到直接照射
	最大输出: 5mW 红光: 最大5mW 媒体: 半导体激光 波长: 658nm 3R类激光产品 GB7247.1 2012	
	激光窗口 LASER APERTURE	

<Label position>

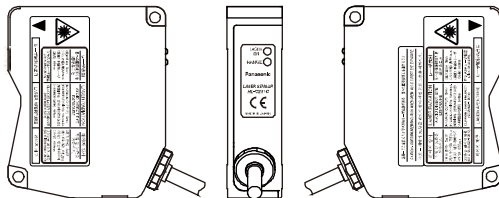

● 350mm type (HL-C235BE)

In Japanese / English / Korean

레이저 방사 출력 표시 표지	LASER RADIATION DO NOT STARE INTO BEAM	레이저放射 注意 直射光線を 見ないこと	
最大出力: 5mW 媒体: 半導体レーザー 波長: 658nm 3R類レーザー製品 (GB7247.1-2012)	MAXIMUM OUTPUT: 5mW MEDIUM: SEMICONDUCTOR LASER WAVELENGTH: 658nm CLASS II LASER PRODUCT (GB7247.1-2012)	最大出力: 5mW 媒体: 半導体レーザー 波長: 658nm 3R類レーザー製品 (GB7247.1-2012)	
레이저 개구 표지	LASER APERTURE	레이저放射의出口	

주의: 이 기기는 레이저 방사(레이저)를 포함하고 있습니다. 레이저 광선(레이저)을 주의하여 주의하십시오.
CAUTION: CLASS II LASER. LASER RADIATION. DO NOT STARE INTO BEAM.
주의: 이 기기는 레이저 방사(레이저)를 포함하고 있습니다.

레이저 방사 출력 표시 표지	LASER RADIATION DO NOT STARE INTO BEAM	레이저放射 注意 直射光線を 見ないこと	
最大出力: 5mW 媒体: 半導体レーザー 波長: 658nm 3R類レーザー製品 (GB7247.1-2012)	MAXIMUM OUTPUT: 5mW MEDIUM: SEMICONDUCTOR LASER WAVELENGTH: 658nm CLASS II LASER PRODUCT (GB7247.1-2012)	最大出力: 5mW 媒体: 半導体レーザー 波長: 658nm 3R類レーザー製品 (GB7247.1-2012)	
레이저 개구 표지	LASER APERTURE	레이저放射의出口	

In Chinese

注意 直射光線を 見ないこと	激光辐射 勿直视光束	
最大輸出: 5mW 媒体: 半導体激光 波長: 658nm 3R类激光产品 GB7247.1-2012	最大輸出: 5mW 媒体: 半導体激光 波長: 658nm 3R类激光产品 GB7247.1-2012	
激光開口	激光開口	

注意 直射光線を 見ないこと	激光辐射 勿直视光束	
最大輸出: 5mW 媒体: 半導体激光 波長: 658nm 3R类激光产品 GB7247.1-2012	最大輸出: 5mW 媒体: 半導体激光 波長: 658nm 3R类激光产品 GB7247.1-2012	
激光開口	激光開口	

<Label position>

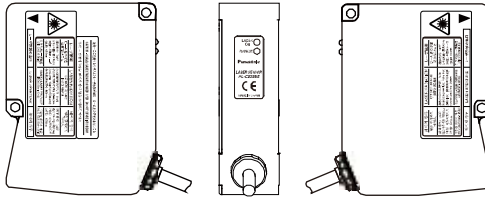

● 350mm type (HL-C235CE)

In Japanese / English / Korean

레이저 방사 출력 표시 표지	LASER RADIATION AVOID DIRECT EYE EXPOSURE	레이저放射 注意 直射光線を 見ないこと	
最大出力: 5mW 媒体: 半導体レーザー 波長: 658nm 3R类レーザー製品 (GB7247.1-2012)	MAXIMUM OUTPUT: 5mW MEDIUM: SEMICONDUCTOR LASER WAVELENGTH: 658nm CLASS II LASER PRODUCT (GB7247.1-2012)	最大出力: 5mW 媒体: 半導体レーザー 波長: 658nm 3R类レーザー製品 (GB7247.1-2012)	
레이저 개구 표지	LASER APERTURE	레이저放射의出口	

주의: 이 기기는 레이저 방사(레이저)를 포함하고 있습니다. 레이저 광선(레이저)을 주의하여 주의하십시오.
CAUTION: CLASS II LASER. LASER RADIATION. AVOID DIRECT EYE EXPOSURE.
주의: 이 기기는 레이저 방사(레이저)를 포함하고 있습니다.

레이저 방사 출력 표시 표지	LASER RADIATION AVOID DIRECT EYE EXPOSURE	레이저放射 注意 直射光線を 見ないこと	
最大出力: 5mW 媒体: 半導体レーザー 波長: 658nm 3R类レーザー製品 (GB7247.1-2012)	MAXIMUM OUTPUT: 5mW MEDIUM: SEMICONDUCTOR LASER WAVELENGTH: 658nm CLASS II LASER PRODUCT (GB7247.1-2012)	最大出力: 5mW 媒体: 半導体レーザー 波長: 658nm 3R类レーザー製品 (GB7247.1-2012)	
레이저 개구 표지	LASER APERTURE	레이저放射의出口	

In Chinese

注意 直射光線を 見ないこと	激光辐射 避免直视光束照射	
最大輸出: 5mW 媒体: 半導体激光 波長: 658nm 3R类激光产品 GB7247.1-2012	最大輸出: 5mW 媒体: 半導体激光 波長: 658nm 3R类激光产品 GB7247.1-2012	
激光開口	激光開口	

注意 直射光線を 見ないこと	激光辐射 避免直视光束照射	
最大輸出: 5mW 媒体: 半導体激光 波長: 658nm 3R类激光产品 GB7247.1-2012	最大輸出: 5mW 媒体: 半導体激光 波長: 658nm 3R类激光产品 GB7247.1-2012	
激光開口	激光開口	

<Label position>

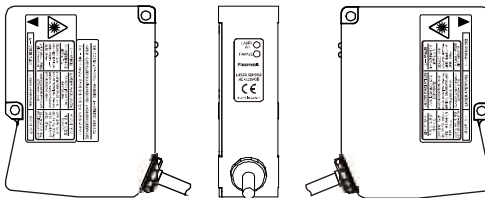

● 350mm type (HL-C235CE-W)

In Japanese / English / Korean

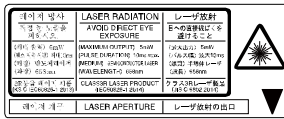

In Chinese



<Label position>

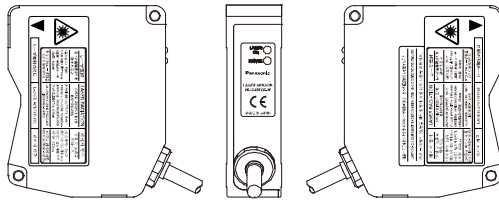

● 8mm type (HL-C201A□-SP2□)

In Japanese / English / Korean



In Chinese (E type only)

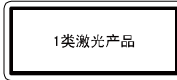

● 15mm type (HL-C201A□-SP3□)

In Japanese / English / Korean



In Chinese (E type only)

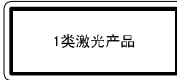

<Label position>

HL-C201A□-SP2□

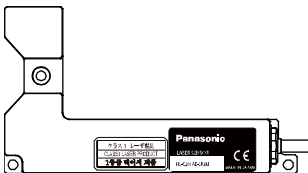

HL-C201A□-SP3□

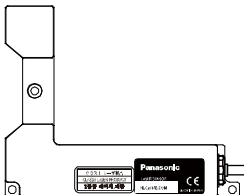

CE

Make sure to use CE compliant sensor head and programmable display for making this product CE compliant.

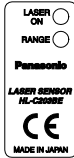

← Confirm the CE mark on the sensor head (or programmable display) to be connected.

■ CE Compliant Condition

To meet the CE compliant condition, attach ferrite cores (SEIWA ELECTRIC MFG. Co., Ltd. E04SR200935A) to the power supply cable and the head cable shown as below.

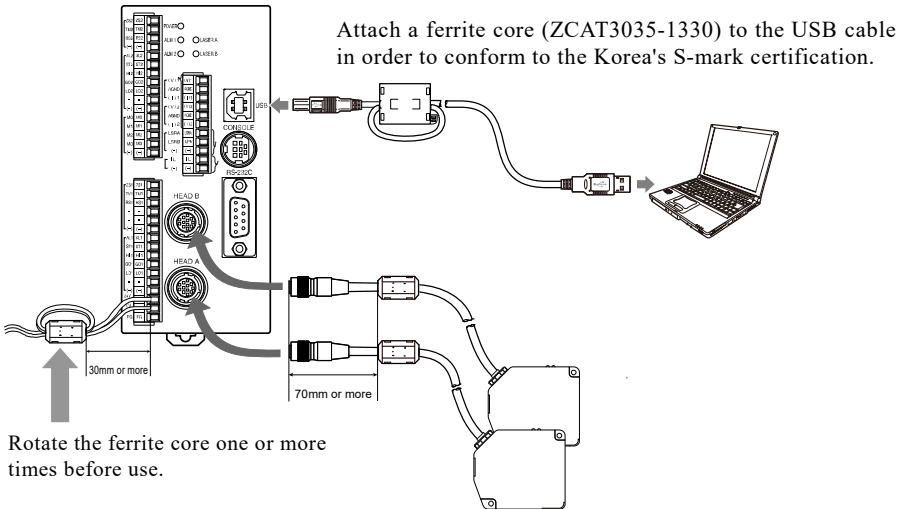

Rotate the ferrite core one or more times before use.

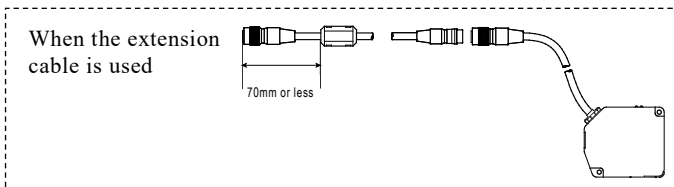

[Contact for CE]

Panasonic Marketing Europe GmbH Panasonic Testing Center
Winsbergring 15, 22525 Hamburg, Germany

FDA

■ Export to US

When the laser product mounted on equipment is exported to the United States, they are subjected to the regulation of the Food and Drug Administration. In order to prevent the injury on users due to laser products from happening, FDA has established PART 1040 (Performance Standards for Light-Emitting Products). FDA classifies laser products according to the degree of risk and provides the safety measures for respective classes (→ Refer to the “FDA Standard” table). Use the FDA-compliant products as shown below.

■ FDA-compliant Product

HL-C201F (E)/HL-C201F (E) -MK
 HL-C203F (E)/HL-C203F (E) -MK
 HL-C205B (E)/HL-C205B (E) -MK/HL-C205C (E)/HL-C205C (E) -MK
 HL-C208B (E)/HL-C208B (E) -MK/HL-C208C (E)/HL-C208C (E) -MK
 HL-C211F (E)/HL-C211F (E) -MK
 HL-C211F5 (E)/HL-C211F5 (E) -MK
 HL-C235CE-W/HL-C235CE-WMK

■ Classification

FDA-compliant products are classified as listed below.

Model	Class
HL-C201F(E)/HL-C201F(E)-MK	I ※1
HL-C203F(E)/HL-C203F(E)-MK HL-C205B (E) /HL-C205B (E) -MK HL-C208B (E)/HL-C208B (E) -MK	II
HL-C211F(E)/HL-C211F(E)-MK	II
HL-C205C (E)/HL-C205C (E) -MK HL-C208C (E)/HL-C208C (E) -MK HL-C211F5(E)/HL-C211F5(E)-MK HL-C235CE-W/HL-C235CE-WMK	III a

*1 10mm type is classified as Laser Class I, Laser Notice No.50.

■ Labeling

The product uses the following labels in accordance with FDA standards.

- Aperture/Warning label, Protective housing label

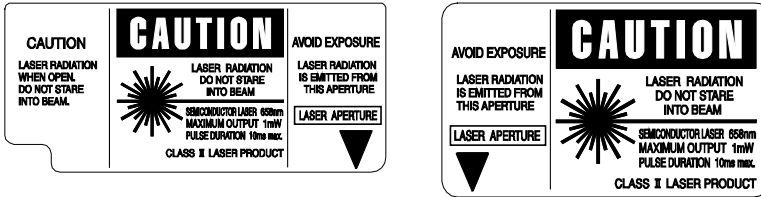

- Certification/Identification label

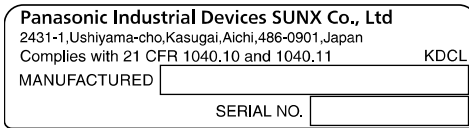

<Label position>

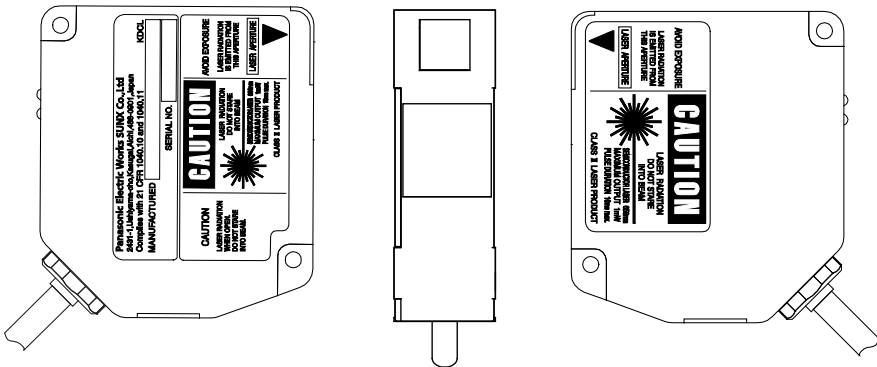

❗ CHECK

The figures above show the examples of major model (for L-C203F(E)/HL-C203F(E)-MK). As for label positions of other models, refer to the Instruction Manual for sensor head included in each product.

■ Beam Attenuator

Use the attached beam attenuator if there is a danger of getting laser beam into your eyes during operation.

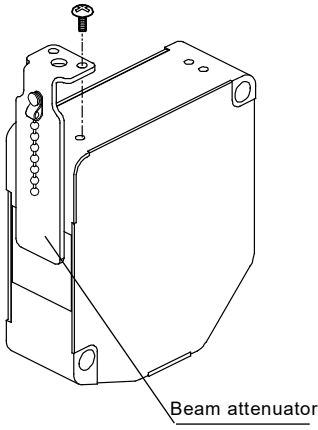

Fix the beam attenuator with the attached screws to cover the light emitting surface.

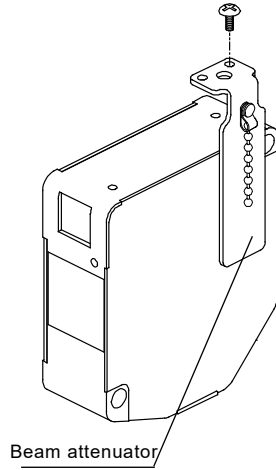

When the beam attenuator is not used, fix it to either side surface of sensor head with the attached screws.

■ FDA Standard

Requirements	Class*1					
	I	IIa	II	IIIa	IIIb	IV
Performance (all laser products)						
Protective housing [1040.10(f)(1)]	R*2	R*2	R*2	R*2	R*2	R*2
Safety interlock [1040.10(f)(2)]	R*3,4	R*3,4	R*3,4	R*3,4	R*3,4	R*3,4
Location of controls [1040.10(f)(7)]	N/A	R	R	R	R	R
Viewing optics [1040.10(f)(8)]	R	R	R	R	R	R
Scanning safeguard [1040.10(f)(9)]	R	R	R	R	R	R
Performance (laser system)						
Remote interlock connector [1040.10(f)(3)]	N/A	N/A	N/A	N/A	R	R
Key control [1040.10(f)(4)]	N/A	N/A	N/A	N/A	R	R
Emission indicator [1040.10(f)(5)]	N/A	N/A	R	R	R*10	R*10
Beam attenuator [1040.10(f)(6)]	N/A	N/A	R	R	R	R
Manual reset mechanism [1040.10(f)(10)]	N/A	N/A	N/A	N/A	N/A	R*13
Performance (specific-purpose products)						
Medical [1040.11(a)]	S	S	S	S*8	S*8	S*8
Surveying, leveling, alignment [1040.11(b)]	S	S	S	S	NP	NP
Demonstration [1040.11(c)]	S	S	S	S	S*11	S*11
Labeling (all laser products)						
Certification/identification [1010.2,3]	R	R	R	R	R	R
Protective housings [1040.10(g)(6),(7)]	D	R*5	R*5	R*5	R*5	R*5
Aperture [1040.10(g)(5)]	N/A	N/A	R	R	R	R
Class warning [1040.10(g)(1),(2),(3)]	N/A	R*6	R*7	R*9	R*12	R*12
Information (all laser products)						
User information [1040.10(h)(1)]	R	R	R	R	R	R
Product literature [1040.10(h)(2)(i)]	N/A	R	R	R	R	R
Service information [1040.10(h)(2)(ii)]	R	R	R	R	R	R

<p>R : Required N/A : Not applicable S : Requirements : Same as for other products of that Class. NP : Not permitted D : Depends on level of inner radiation</p>
--

- *1 Class is based on the maximum level of laser exposure during operation.
- *2 Required wherever and whenever such human access to laser radiation levels that exceed the limits of Class I is not necessary for the product to perform its intended function.
- *3 Required at the protective housing which is designed to be removed or displaced during operation or maintenance, if removal or displacement of the protective housing could permit human access to laser or collateral radiation.
- *4 The requirements for interlock differ depending on the class of inner radiation.
- *5 The contents of label differ depending on the level and wavelength of laser radiation inside the protective housing.
- *6 Warning statement label
- *7 CAUTION logotype
- *8 The method to measure the level of laser radiation to human body is required.
- *9 CAUTION if 2.5mWcm^{-2} or less, DANGER if greater than 2.5mWcm^{-2} .
- *10 Time difference is needed between instruction and emission.
- *11 Exception should be provided for demonstration of laser products or light shows using laser of Class IIIb or IV.
- *12 DANGER logotype
- *13 Required after August 20, 1986.

Remote Interlock

Interlock control input terminal can be used as the emergency stop circuit for safety purposes.

- For NPN type, laser beam emission can be stopped by opening the IL terminal and (-) terminal.
- For PNP type, laser beam emission can be stopped by opening the IL (+) terminal and IL (-) terminal.

At factory shipment, the short bar for short circuit is attached to the remote interlock terminal.

Remove the bar and connect the cable when using the interlock control function.

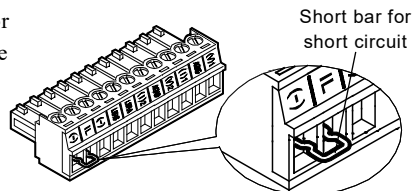

Export Regulations by Japanese Government

■ Compliance with Export Regulations by Japanese Government

Some models are subject to export control, which is defined by “Foreign Exchange and Foreign Trade Act”.

● Export controlled products

Below products fall under the export control, which is defined by “Foreign Exchange and Foreign Trade Act”. When exporting or transferring these products outside of Japan, the license from the Japanese government is required.

Also, these products fall under the international export control regime, such as NSG (Nuclear Suppliers Group) guidelines 1.B.3.b.1 and WA (Wassenaar Arrangement) 2.B.6.b.1.a, and are objects of the regulation. Please comply with the export control in each country.

HL-C2C(-□), HL-C21C(-□): Controller is the export controlled item
 HL-C2□□□(-□□) : Sensor head is the export controlled item

● Export uncontrolled products

Below products do not fall under the export control, which is defined by “Foreign Exchange and Foreign Trade Act”.

HL-C2CE(-□), HL-C21CE(-□) : Controller that does not fall under the control
 (E type controller)
 HL-C2□□□E(-□□) : Sensor head that does not fall under the control
 (E type sensor head)

* Use the standard cable and programmable display.

* To identify E type, see the type identification plate affixed on the sensor, the programmable display or intelligent monitor AiM.

❗ CHECK

Select the combination of E type controller and E type sensor head mentioned above, not to be subject to export control regulation. If either the controller or the sensor head is export controlled product, the product is subject to export control regulation.

■ Specification of Export Uncontrolled Product

The specification of display resolution and measurement resolution for the export uncontrolled products are shown below. Other specifications not mentioned here are the same as export controlled products.

Resolution	0.25 μ m
------------	--------------

- * The programmable display and Intelligent Monitor AiM displays the measured value in increments of 0.25 μ m.
- * Numerical input, e.g. setting of upper limit for comparison judgment output, can be set in increments of 0.001 μ m. The internal processing, however, is done in increments of 0.25 μ m. In this case positive values are omitted and negative values are rounded up.
- * Settings by USB and RS232 are also possible in increments of 0.001 μ m. The data of measurement value responded is incremented by 0.25 μ m.
- * If you change the default value of operation coefficient setting, the displayed measurement value will not be incremented by 0.25 μ m.

■ Functional Restriction

- When the export controlled sensor head is connected to the E type controller, lasers on both Head A and Head B turn off. The output of measurement value for OUT1 and OUT2 become zero. In such a state the alarm output is always ON and the system is unusable.
- In case the E type head is connected to the export controlled controller, the product can be used without restrictions in functions or specifications. This combination of controller and sensor head, however, is subject to export control regulations.

Type and operation of sensor head connected to E type controller

Connecting head		Operation
Head A	Head B	
E type	E type	○
E type	-	○
E type	Controlled	×
Controlled	E type	×
Controlled	Controlled	×
Controlled	-	×

- * The Code 6 is returned when alarm output is read using the external communication function while the export controlled head is connected to the E type controller. → “Chapter 5 External Communication Control”

1

Prior to Use

This chapter explains the configuration, installation method, and connection method of the system (Controller, Sensor Head, Compact Programmable Display, and Intelligent Monitor AiM).

1-1 System Configuration	1-2
1-1-1 System Configuration	1-2
1-1-2 System Components & Accessories List ..	1-3
1-2 Part Names and Functions	1-7
1-2-1 Controller	1-7
1-2-2 Sensor Head	1-9
1-3 Installation Method	1-10
1-3-1 Controller	1-10
1-3-2 Sensor Head	1-11
1-4 Connection	1-15
1-4-1 Connection Method of Power Supply ..	1-15
1-4-2 Connection Method of Terminal Block ..	1-15
1-4-3 Connection of Intelligent Monitor AiM (PC)	1-17

1-1 System Configuration

1-1-1 System Configuration

The system configuration and the cables for connecting the devices are shown as below.

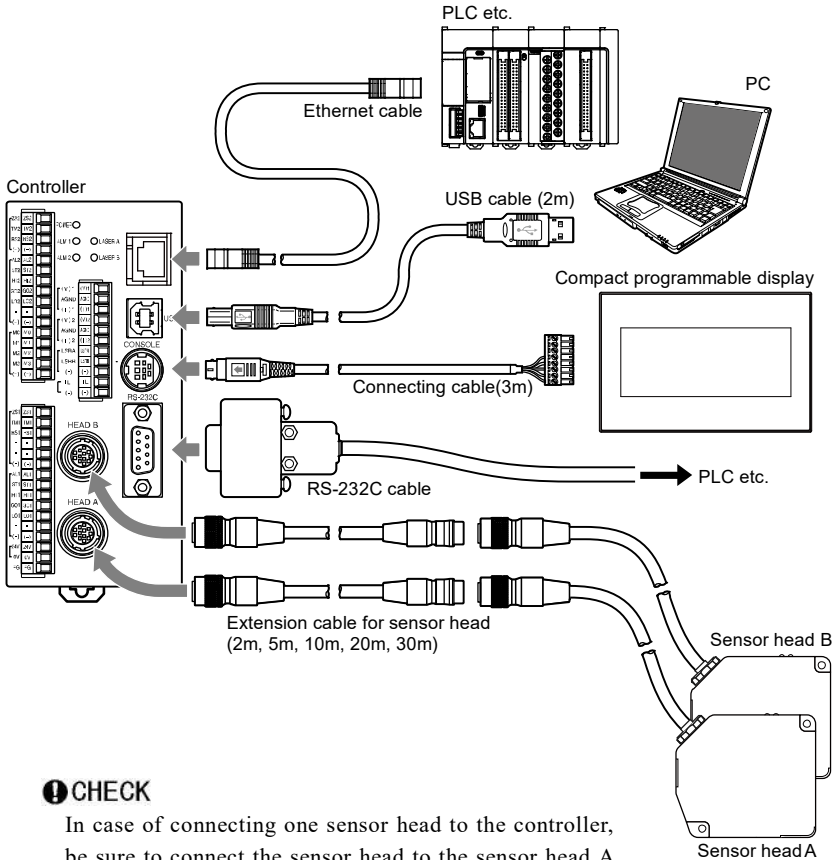

❗ CHECK

In case of connecting one sensor head to the controller, be sure to connect the sensor head to the sensor head A connection (HEAD A) side.

If the sensor head is connected to the sensor head B connection (HEAD B) side, the measurement cannot be performed.

Refer to → “1-4 Connection” for proper connection of each device.

1-1-2 System Components & Accessories List

■ Controller Accessories

The accessories of the controller are as shown below.

Main unit of controller

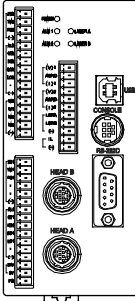

Above figure is the main unit of NPN type "HL-C2C" controller.

I/O terminal block

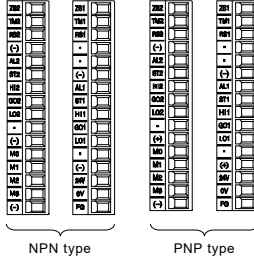

NPN type

PNP type

Analog output/laser control terminal block

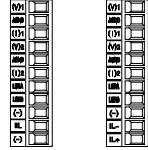

NPN type

PNP type

1

Ferrite core

SEIWA ELECTRIC
MFG. Co., Ltd.
E04SR200935A × 3

TDK
ZCAT3035-1330 × 1
*1

Short bar



The short bar is already installed with the remote interlock terminal as default.

RS-232C protection cap

*1



*1: HL-C2C□ is attached.



*1: HL-C2C□ is attached.

USB cable (2m)

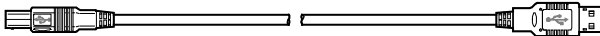

HL-C2 Series Instruction Manuals



■ Sensor Head Accessories

The accessories of the sensor head are as shown below.

Main unit of sensor head

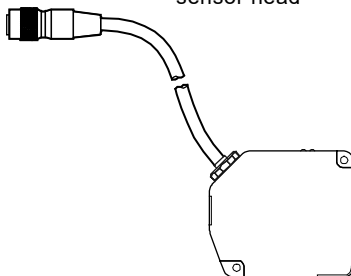

Warning label

In Japanese / English / Korean

注意—この装置はレーザー放射の照射を受けるレーザー照射装置です。 CAUTION—CLASS II LASER RADIATION FROM OPEN BEAM. DO NOT STARE INTO BEAM. 주의—이 장치는 레이저 방사선을 방출하는 레이저 장치입니다.		
레이저의 방사 위험을 피하기 위하여 레이저 빛을 직접 눈으로 보거나 피부에 닿지 마세요.	LASER RADIATION DO NOT STARE IN TO BEAM MAXIMUM OUTPUT: 10mW WAVELENGTH RANGE: 650nm-670nm LASER CLASS: CLASS II LASER WAVELENGTH: 650nm	레이저 방사 위험을 피하기 위하여 레이저 빛을 직접 눈으로 보거나 피부 에 닿지 마세요.
레이저의 방사: LASER APERTURE 레이저 방사선의出口		

In Chinese (E type only)

注意 行方對標準應注意 勿當視光線	激光辐射 勿直視光束 最大輸出: 10mW 波長: 650nm 媒体: 半导体激光 波长: 650nm 2类激光产品 GB7247.1-2012	
激光窗口		

Instruction manual of sensor head



■ ND Filter Unit (Optional)

ND Filter Unit (Type: HL-C2F01)

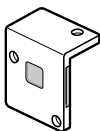

Mounting screws



■ Extension Cable for Sensor Head (Optional)

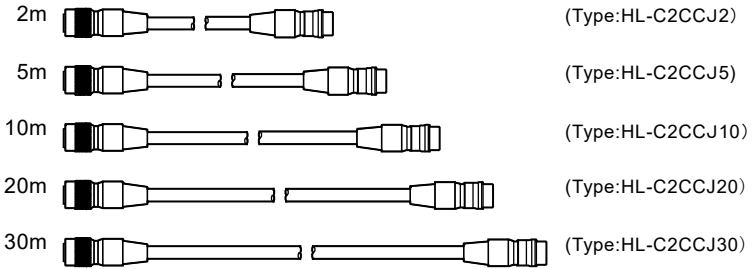

■ Compact programmable display (Optional)

Refer to the "HL-C2 Series User's Manual: Programmable Display" for handling regarding installation and connection.

Refer to "Chapter 3 Programmable Display Operation" for the operation method.

Main unit of compact programmable display

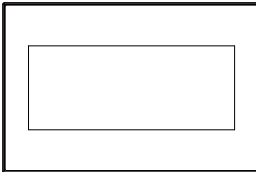

Compact programmable display brackets & Screws

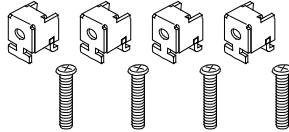

Product name	Screen	Backlight	Body color	Product no.
GT12G	4.6-inch STN 320 x 120 dots	Green /Orange /Red	Pure black	AIG12GQ02D
				AIG12GQ12D
			Hairline silver	AIG12GQ03D
				AIG12GQ13D
GT12M	4.6-inch STN 320 x 120 dots	White /Pink/ Red	Pure black	AIG12MQ02D
				AIG12MQ12D
			Hairline silver	AIG12MQ03D
				AIG12MQ13D

Terminal block for compact programmable display



- **Connection cable for compact programmable display (3m) (Optional)**

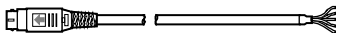

(Type: HL-C2GT-C3)

1

- **Intelligent Monitor AiM**

Intelligent Monitor AiM and “HL-C2 Series USER’S MANUAL: Intelligent Monitor AiM” can be downloaded on our website (<https://panasonic.net/id/pidsx/global>).

- **Ethernet Communication Setting Tool**

Ethernet Tool Configurator WD (compatible to Ver.1.62 and later) can be downloaded on our website (<https://panasonic.net/id/pidsx/global>).

1-2 Part Names and Functions

1-2-1 Controller

●HL-C20□

●HL-C21C□

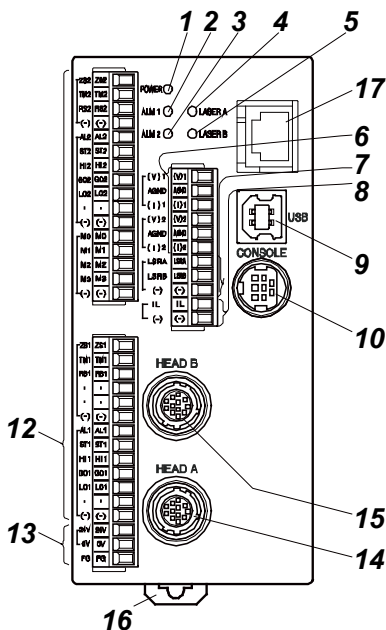
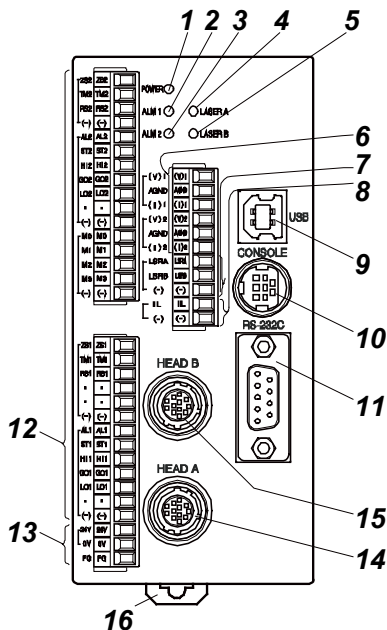

1. POWER Indicator

Lights up in green when electricity is provided to the controller.

2. ALM1 (Alarm) Indicator

Abnormal condition indicator for OUT1.

Lights up in red during dark status (poor light intensity) of OUT1 or the sensor head is unconnected status.

3. ALM2 (Alarm) Indicator

Abnormal condition indicator for OUT2.

Lights up in red during dark status (poor light intensity) of OUT2 or the sensor head is unconnected status.

4. LASER A Indicator

Lights up in green during the laser radiation of Head A.

5. LASER B Indicator

Lights up in green during the laser radiation of Head B.

6. Analog Output Terminal

Terminal for analog data output.

7. Laser Control Terminal

Stops laser emission in case of short-circuiting.

8. Remote Interlock Terminal

Stops laser emission when its opened.

9. USB Connector

Used for communication with PC using USB.

10. Programmable Display Connection Connector

Used for connecting the compact programmable display.

11. RS-232C Connector (* Only HL-C2C□ is equipped.)

Used for communication with the control devices using RS-232C.

12. I/O Terminal

Terminal for various I/O (Zero Set Input, Timing Input, Reset Input, Alarm Output, Strobe Output, and Judgment Output) and memory change.

Refer to → “2-1 Functions and Arrangements of I/O Terminal Block”.

13. Power Terminal

Terminal for power supply to the controller.

Refer to → “1-4 Connection” - “Power Connection”.

14. Sensor Head A Connection Connector

Controller recognizes a sensor head which is connected to this connector as “Sensor Head A” and starts operation.

15. Sensor Head B Connection Connector

Controller recognizes a sensor head which is connected to this connector as “Sensor Head B” and starts operation.

16. DIN Rail Mounting Hook

Used for hooking/removing the sensor heads to/from the 35mm width DIN rail with one-touch simple operation.

17. Ethernet Connector (* Only HL-C21C□ is equipped.)

Used for communication with the control devices using Ethernet.

❗ CHECK

In case of connecting one sensor head to the controller, be sure to connect the sensor head to (14) the sensor head A connection (HEAD A) side.

If the sensor head is connected to (15) the sensor head B connection (HEAD B) side, the measurement cannot be performed.

1-2-2 Sensor Head

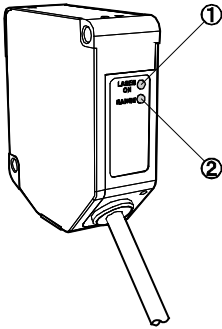

- (1) **Laser Emission Indicator (LASER ON)**
Lights up in green during laser emission.
- (2) **Measurement Range Indicator (RANGE)**
Lights up in yellow when the target reaches at approximately center of the measurement.
Blinks in yellow when the target enters within the measurement range.
Turns off the light when the target goes out of the measurement range.
Refer to → “8-6 Characteristics” - “Output Characteristics and Measurement Range Indicator”.

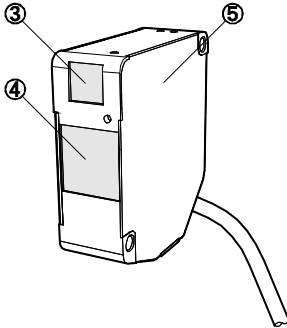

- (3) **Light Emitter**
Emits the laser light.
- (4) **Light Receiver**
Receives the laser specular light from a measurement target.
- (5) **Warning Label**
Shows the laser emission position.
Please read carefully before use.

1-3 Installation Method

Before installing each device, read carefully the explanation of the setting environment, concerning about noise or radiation, and the power supply. Refer to →“Correct Handling”.

1

1-3-1 Controller

The controller can be installed by using DIN rail or using screws.

■ Installation by Using DIN Rail

The controller can be easily installed/uninstalled by using 35mm width DIN rail (DIN EN50022) with one-touch operation.

Installation

- 1 Hook the upper tab on the DIN rail.
 - 2 Push the bottom of the controller until it clicks.
- The installation of the controller is completed.

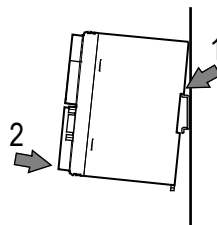

Removal

- 1 Insert the flathead screwdriver in the mounting lever.
- 2 Pull down the mounting lever.
- 3 Raise the controller and remove it.

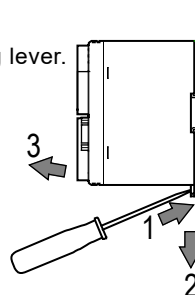

■ Installation by Using Screws

Using two M4 screws, fix the controller securely. The tightening torque should be 0.7N·m or less.

→Refer to “8-5 Outside Dimension”.

1-3-2 Sensor Head

Securely fix the sensor head in two screw holes using M5 screws.

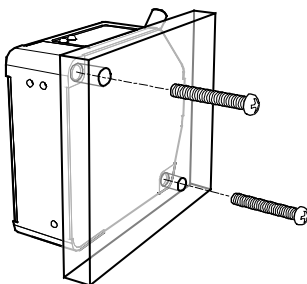

1

❗ CHECK

- The tightening torque should be 1.2N·m or less.
- The depth of both screw holes is 10mm, not through-holes. Be careful to choose screws with considering its length.

■ Installation Direction of Sensor Head

To obtain the greatest precision and the best stability, the sensor head should be oriented facing the direction of the measurement targets as shown in the figure below.

● Installation direction for the moving target

• Measurement of extremely different adjacent colors or materials

When measuring a moving target that is extremely different adjacent colors or materials, the direction of the sensor head should be as shown below to minimize the measurement error.

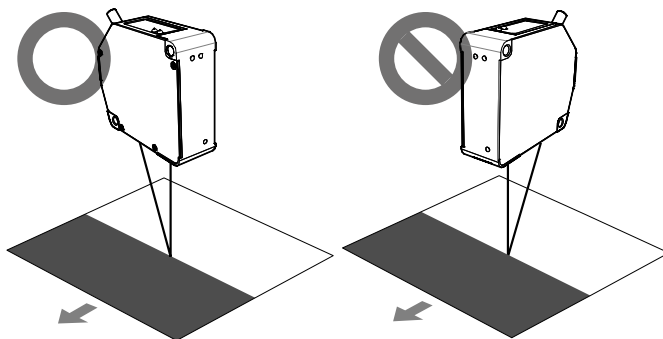

1

• Measurement of a rotating target

When measuring a rotating target, the direction of the sensor head should be as shown below to minimize the effect of vertical oscillation or displacement.

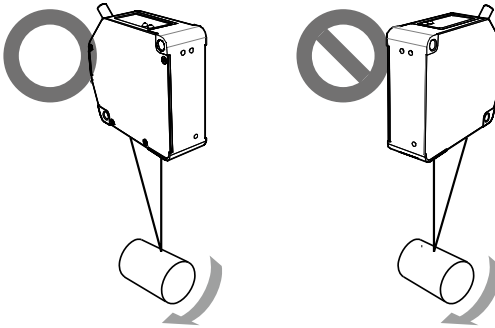

• Measurement of step detection

When measuring a moving target that has difference grooves, the direction of the sensor head should be as shown below to minimize interference caused by target edges.

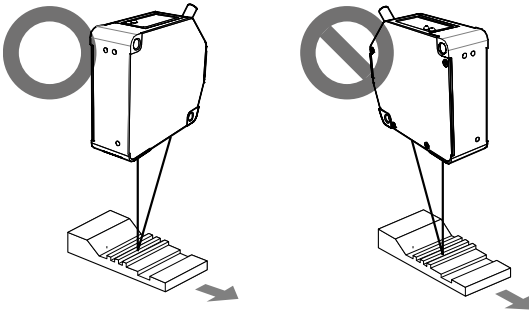

• Measurement of a target in narrow space or slot

When measuring a target in narrow space or slot, the direction of the sensor head should be as shown below so that the emitted and received light are not blocked.

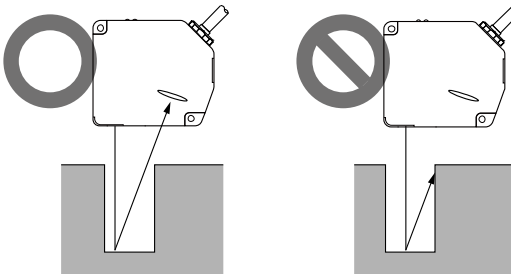

- Measurement of a black target or low-light intensity

When measuring a low-reflectance black target, light intensity reflected from the target decreases and the signal from the linear image sensor is also getting smaller. As a result, it decreases the resolution. So mount the sensor head as shown below to increase the light received intensity.

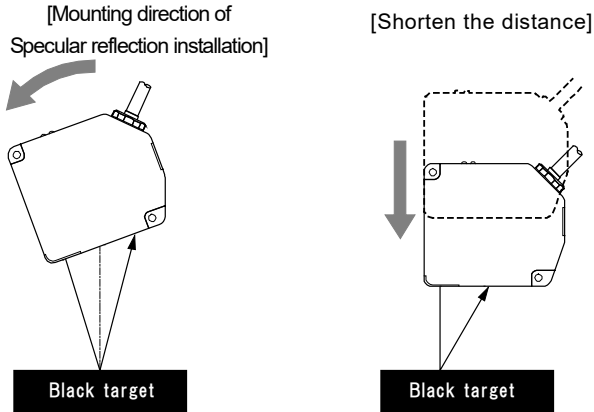

Tilt the sensor head in the direction of specular reflection. The light amount will increase.

Light received intensity is inversely proportional to the square of the distance to the measuring target. Place the sensor head closer to the target to increase the light received intensity.

- When mounting the sensor head to a wall surface

The direction of the sensor head should be as shown so that the receiver does not receive the multiplex reflected beam from the wall. If the wall reflectance is high, painting the surface matte-black is effective.

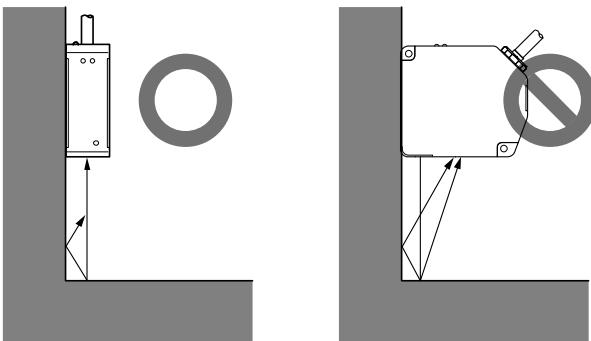

- Angle between the measurement center and the sensor head

Diffuse reflection surface

Mount the sensor head as shown at the right, so the emitter surface and receiver surface of sensor head is parallel to a measuring target.

For the measurement center distance and measurement range, refer to → “8-2 Sensor Head Specifications”.

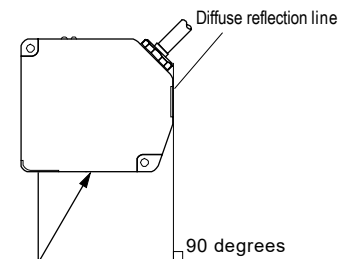

Specular reflection surface

Mount the sensor head as shown at the right, so the angle between the emitting and receiving laser light is symmetry to a measuring target.

Make sure that the specular reflection line (tilt of the head) is perpendicular to a measuring target as shown in the right.

For the measurement center distance and measurement range, refer to → “8-2 Sensor Head Specifications”.

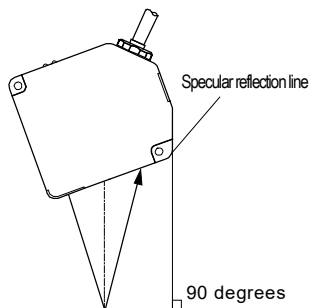

■ Mounting ND Filter

Mount the ND filter (option) in case the amount of reflected beam is too large on specular reflection installation.

Securely tighten the two attached M2.6 bind screws (4mm length) to two screw holes on the sensor head. The tightening torque should be 0.3N·m or less.

ⓘ CHECK

Carefully mount ND filter not to get fingerprints or damage on the glass. If you do get fingerprints or other stain on the lens, wipe it off with an optical cloth.

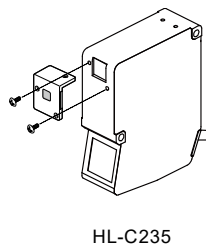
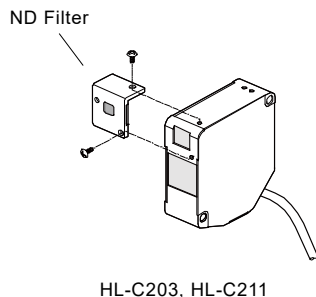

1-4 Connection

1-4-1 Connection Method of Power Supply

- Connect 24VDC power supply wiring with “24V” and “0V” terminals of the terminal 3.
- Use twisted wires to minimize the effect of noise.

Rated Voltage	24VDC
Tolerance Voltage Variation Range	21.6 to 26.4VDC
Consumption Current	One sensor head: approx. 0.45A Two sensor heads: approx. 0.6A
Incoming Current	8A or less

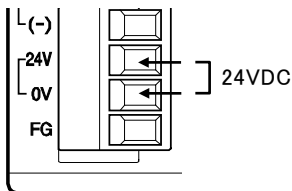

1

1-4-2 Connection Method of Terminal Block

The controller has three terminal blocks.

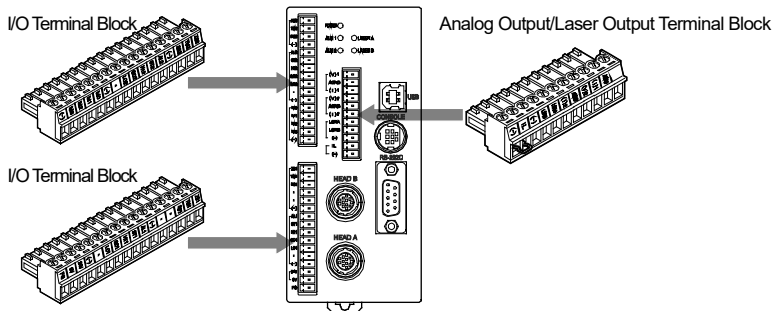

■ Model Number of Terminal Blocks

The terminal blocks are detachable from the controller and fixed with screws. Use the tools and electric wire in the below list.

Terminal Block Socket	Manufacturer	Type
	PHOENIX CONTACT Ltd	MC1.5/16-ST-3.5(Color:Black) MC1.5/11-ST-3.5(Color:Black)
	Degson Electronics Co., Ltd.	15EDGK-3.5-11P-13-1187A(H) (Color:Black) 15EDGK-3.5-16P-13-1187A(H) (Color:Black)
Tightening Tool	Flathead Screwdriver	Tightening Torque
	Blade Width: 0.4 X 2.5	0.22 to 0.25N·m
Adaptable Electric Wire (Stranded Wire)	Size	Cross-section Area
	AWG#24 to 15	0.5 to 1.5mm ²

■ Wiring Method

- 1 Strip insulation from the end of the wire.

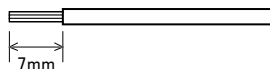

- 2 Insert the wire in the terminal block until it contacts the back, then, secure it by tightening the screw.

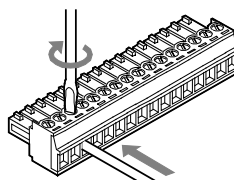

- 3 If two or more terminals are connected, twist wires before inserting them.

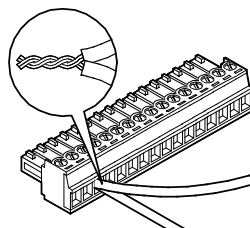

❶ CHECK

- Be sure to turn off the power supply before wiring or detaching the terminal blocks.
- Never use wires tinned with solder. They may break by vibration.
- The length of the wire should be 30m or less.

1-4-3 Connection of Intelligent Monitor AiM (PC)

A USB driver must be installed to a PC before connecting a controller and PC installed Intelligent Monitor AiM.

For installation of the USB driver, refer to the “HL-C2 Series Intelligent Monitor AiM USER’S MANUAL”.

The below operating environment is required for operating the intelligent monitor AiM.

Operating environment	
OS	Microsoft Windows® 7 Professional 32bit/64bit Microsoft Windows® 8.1 Pro 32bit/64bit Microsoft Windows® 10 Professional 32bit/64bit (Japanese, English, Chinese, Korean)
CPU	1GHz or more processor* ¹
Hard Disc	50MB or more of available memory
Memory	2GB or more* ¹
Display	SXGA (1280 × 1024 full color) or more
USB Port	USB 2.0 Full Speed (USB 1.1 compatible) compliant
Serial Port	RS-232C-compliant, Communication speed: 115.2kbps

*1 It depends on the operation environment of OS.

*Windows is a registered trademark of Microsoft Corporation in the United States and other countries.

■ Connection

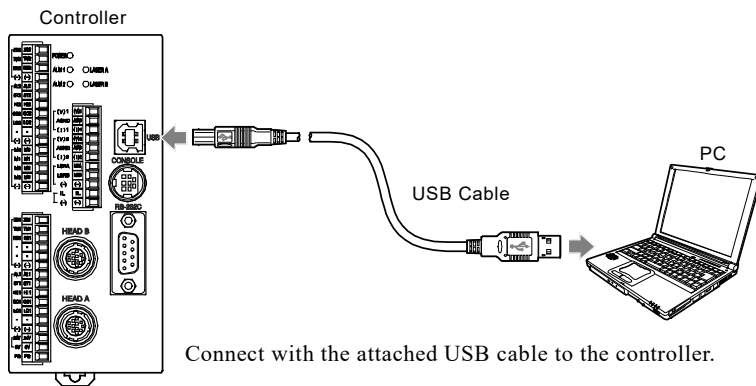

MEMO

1

2

I/O Terminal Block

This chapter explains I/O terminal blocks on the controller.

2-1 Functions and Arrangements of I/O Terminal Block	2-2
2-2 I/O Circuit	2-4
2-3 Interlock Circuit	2-6
2-4 Analog Output Circuit	2-7
2-5 Timing Chart	2-8

2-1 Functions and Arrangements of I/O Terminal Block

Analog output terminal block/Laser control terminal block

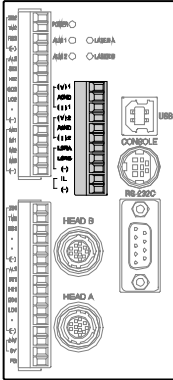

Terminal		Function
NPN	PNP	
(V)1		Analog voltage output (for OUT1)
AGND		Analog ground
(I)1		Analog current output (for OUT1)
(V)2		Analog voltage output (for OUT2)
AGND		Analog ground
(I)2		Analog current output (for OUT2)
LSRA		Laser control input (for Head A) Laser stop during short circuit
LSRB		Laser control input (for Head B) Laser stop during short circuit
(-)		Common (-)
IL	IL-	Remote interlock Laser stop when opened.
(-)	IL+	Remote interlock common

I/O terminal block

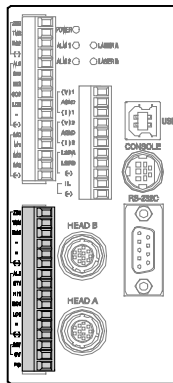

Terminal		Function
NPN	PNP	
ZS1		Zero set input (for OUT1) ON during short circuit*
TM1		Timing input (for OUT1) ON during short circuit
RS1		Reset input (for OUT1) ON during short circuit
.		Reserved terminal
.		Reserved terminal
(-)		Common (-)
AL1		Alarm output (for OUT1)
ST1		Strobe output (for OUT1)
HI1		Judgment HI output (for OUT1)
GO1		Judgment GO output (for OUT1)
LO1		Judgment LO output (for OUT1)
.		Reserved terminal
(-)	(+)	Common (-)/Common (+)
24V		24VDC input for power supply
0V		Power supply ground 0V
FG		Frame ground

* Turn off the terminal in case short circuit lasts for more than one second.

Refer to → "1-4 Connection" for the connection method of terminal block.

! CHECK

Do not connect anything to the reserved terminals; they are connected to the internal circuit.

I/O terminal block

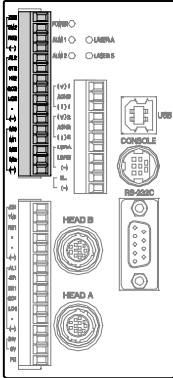

Terminal		Function
NPN	PNP	
ZS2		Zero set input (for OUT2) ON during short circuit*
TM2		Timing input (for OUT2) ON during short circuit
RS2		Reset input (for OUT2) ON during short circuit
(-)		Common (-)
AL2		Alarm output (for OUT2)
ST2		Strobe output (for OUT2)
HI2		Judgment HI output (for OUT2)
GO2		Judgment GO output (for OUT2)
LO2		Judgment LO output (for OUT2)
.		Reserved
(-)	(+)	Common (-)/Common (+)
M0		Memory change (16 ways)
M1		
M2		
M3		
(-)		Common (-)

* Turn off the terminal in case short circuit lasts for more than one second.

Refer to → “1-4 Connection” for the connection method of terminal block.

❗ CHECK

Do not connect anything to the reserved terminals; they are connected to the internal circuit.

2-2 I/O Circuit

■ NPN Type

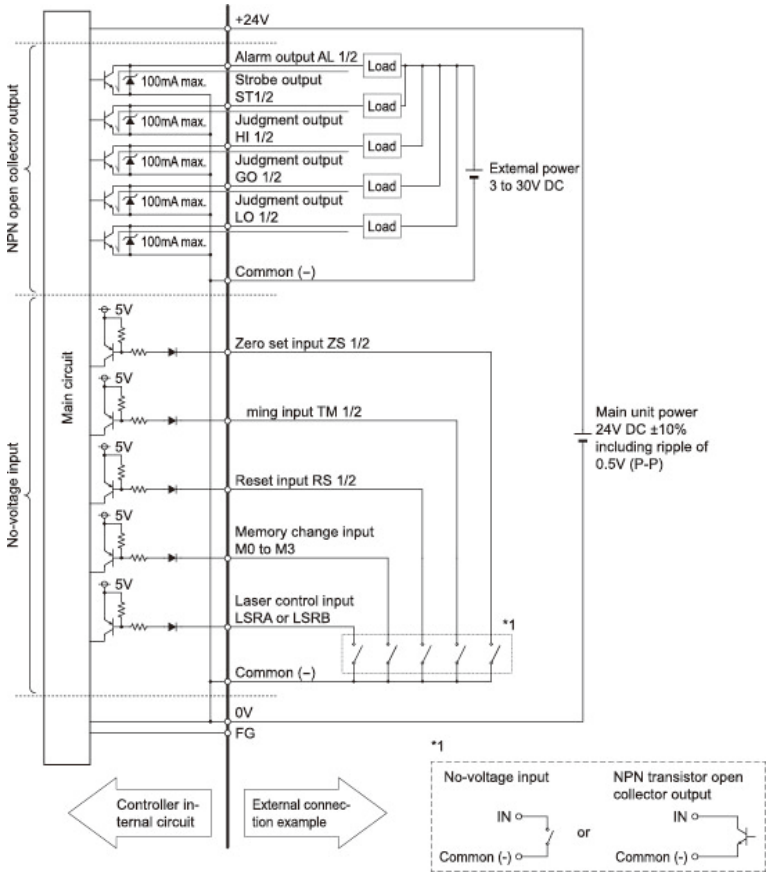

❗ CHECK

The common (-) and the power supply (0V) for main unit are internally connected. Be sure not to cause the potential difference at operation.

■ PNP Type

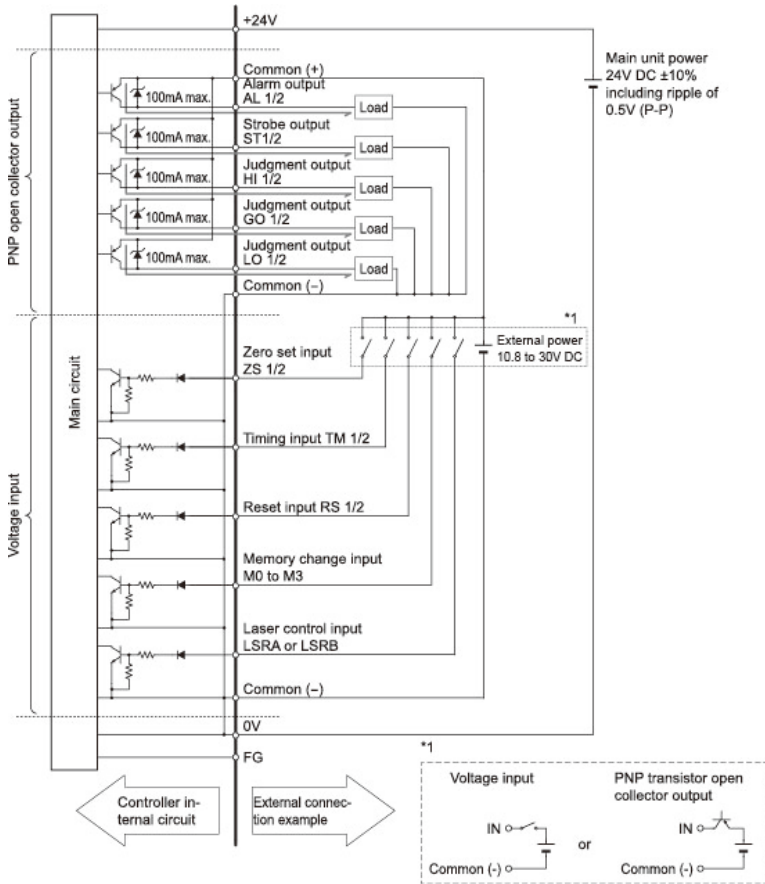

❶ CHECK

The common (-) and the power supply (0V) for main unit are internally connected. Be sure not to cause the potential difference at operation.

2-3 Interlock Circuit

■ NPN Type

Connect IL and Common (-) in case of NPN output type.

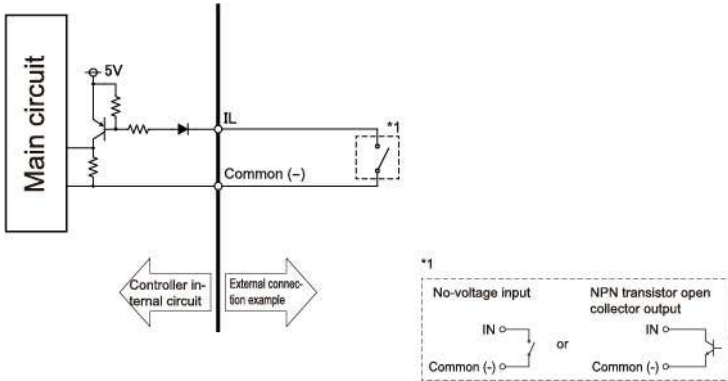

■ PNP Type

Connect IL+ and IL- in case of PNP output type.

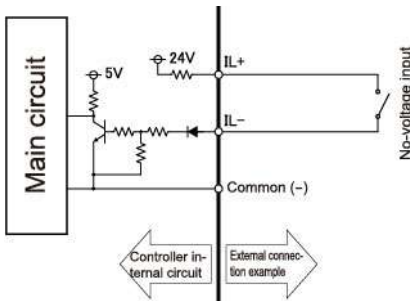

❗ CHECK

IL+ is connected to the 24V power supply at the internal circuit. Do not connect the voltage input or PNP transistor open collector output to it.

2-4 Analog Output Circuit

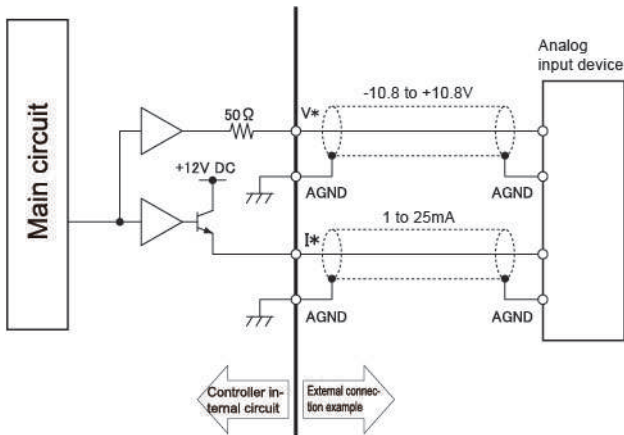

*: Either “1” or “2” is entered.

❗ CHECK

- Do not short-circuit analog output terminals or apply voltage to them.
- Make sure that no potential difference will be generated between AGND on the controller side and AGND on the analog input device side during use. If a potential difference occurs between them, damage may result.
- Use shielded wires for analog outputs.

2-5 Timing Chart

• Normal measurement

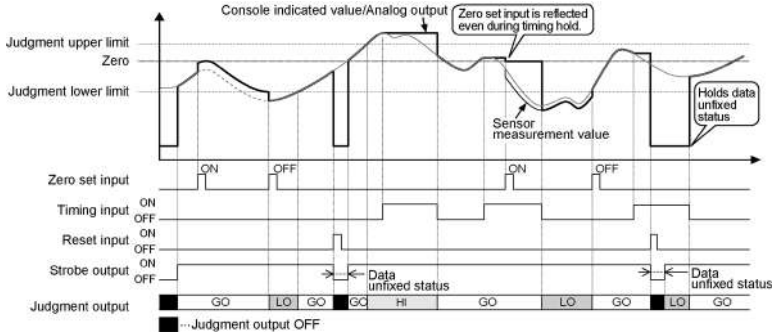

• Peak/bottom measurement

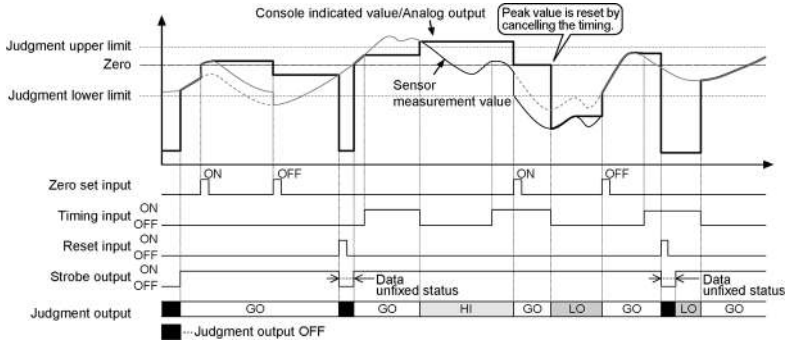

The above chart uses peak measurement for explanation.

• Peak to peak measurement

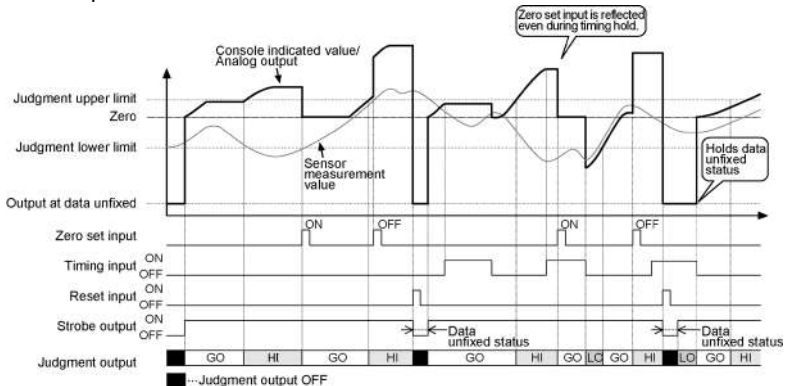

- Zero set by timing input during HOLD status is valid.
- Reset input by timing input during HOLD status causes data unfixed status. The system holds this status until the timing input is cancelled.
- Zero set input during data unfixed status is invalid.
- The system holds reset input during data unfixed status until the timing input is cancelled.
- Judgment output is determined by the measurement value, judgment output upper limit, and judgment output lower limit. It is turned to OFF during data unfixed status.
- At any data unfixed status other than that caused by reset input, the programmable display displayed value, analog output, and judgment output do the same performances as the reset input operation.
- Analog output during data unfixed status is indicated by the setting of initial value.
- When “Offset” is set, the offset value is added at execution of zero set.
- If zero set is executed during peak to peak measurement, the measurement value at that time becomes the zero (reference value of measurement). Therefore, inputting reset during executing zero set makes the reference value of measurement a negative (-) value.
- When digital output at alarm is fixed, judgment output is conjunction with the fixed value.

Processing of zero set/timing/reset input

	On timing input	Reset input (during data unfixed)
Zero set input (ON/OFF)	The input is reflected at the moment of zero set (programmable display displayed value and analog output).	Invalid
Timing input	/	Hold data unfixed status.
Reset input	The data unfixed status occurs at the moment of reset input (HOLD status while timing input is ON).	/

Function of timing input (level)

Analysis mode	Function
Normal measurement	This mode holds the measurement value when timing input turns to ON. The HOLD status is cancelled when it turns to OFF.
Peak/bottom measurement	This mode starts the HOLD status when input signal turns to ON. The HOLD status is cancelled when it turns to OFF. The peak (bottom) value is reset when the HOLD status is cancelled.
Peak to peak measurement	This mode starts the HOLD status when input signal turns to ON. The HOLD status is cancelled when it turns to OFF. The data is set to zero when the HOLD status is cancelled.

● Laser control

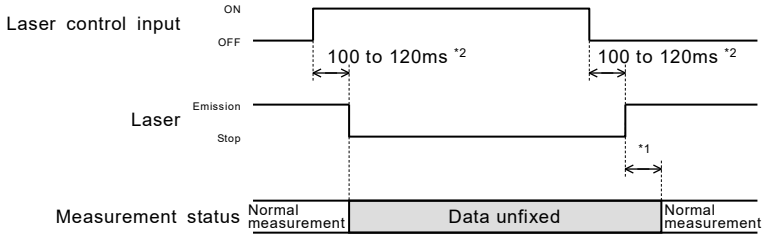

● Interlock control

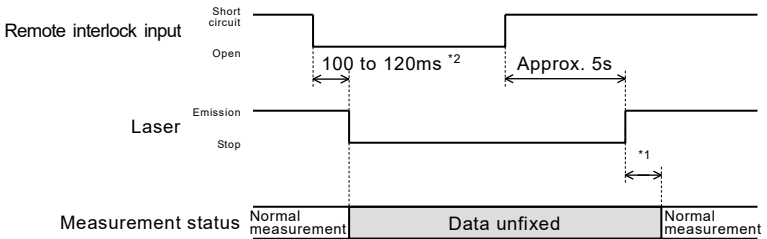

*1 Sampling period (Ts) × average number of times

Laser stability time is also required.

*2 For laser stop input, remote interlock input and memory change input, the setting should be ON2 (continuous input for more than 100ms), regardless of the setting in Chattering Prevention for Terminal Input
Refer to → “4-3-3 Common Setting” - “Chattering Prevention for Terminal Input”.

3

Programmable Display Operation

3-1 Operation Screens	3-2
3-2 Basic Operation	3-6
3-2-1 First Measurement	3-6
3-3 Screen Transition Diagram	3-10
3-3-1 Display Waveform of Received Light Intensity	3-14
3-3-2 Received Light Intensity at Peak	3-14

The screen data and "HL-C2 Series User's Manual: Programmable Display" can be downloaded from our website (<https://panasonic.net/id/pidsx/global>).

3-1 Operation Screens

■ Screens

- Top menu and Setting menu

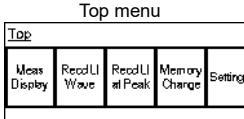

The left figure shows the Top screen.

All kinds of screens displayed on the programmable display can be changed through any of the keys on the Top menu.

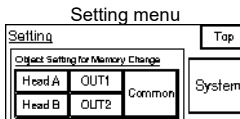
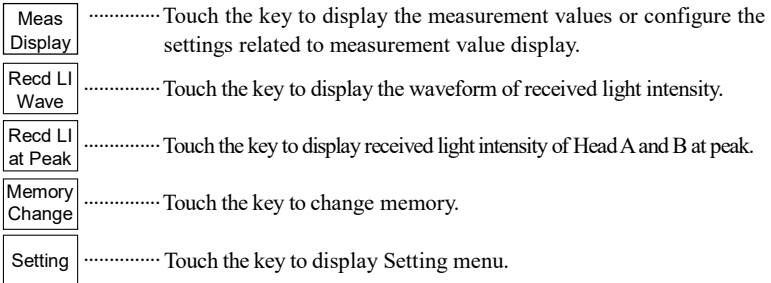

Touching respective keys moves the screen to corresponding menu.

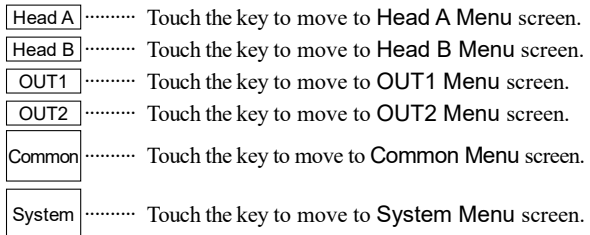

- Operation of basic keys

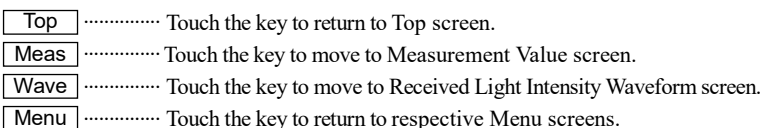

■ Shift Screen Levels

The operation screen consists of hierarchical tree structure.

Touch the keys to move to the desired screen and set the required items.

Touch the keys to shift the screen among the same hierarchical level.

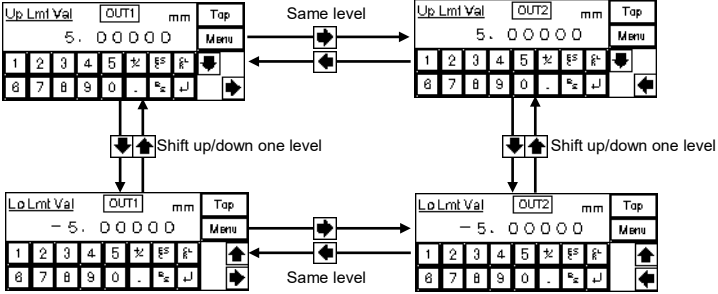

..... Shift to lower tier by one level

..... Shift to upper tier by one level

..... Advance to another item on the same level

..... Return to another item on the same level

} Change between Head A/B or OUT1/2, or change of Menu

■ Select Variables from among Alternatives

This section explains how to select the variables from among alternatives.

【Case 1: small number of alternatives】

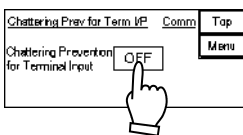

The variable changes every time the key is touched.

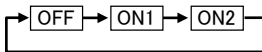

【Case 2: large number of alternatives】

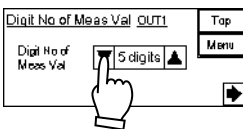

The variable changes every time the key is pressed.

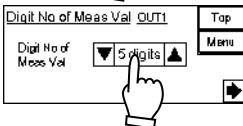
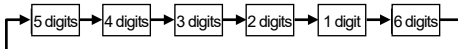

Touch the key to change the variable in reverse order.

Touching the setting value displayed between the and keys returns the setting to the initial value.

■ Enter Value

This section explains how to enter the numerical value for upper/lower limit value or offset. A numerical keypad is displayed on the screen for numerical input.

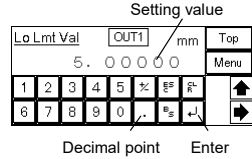

- 1 Touch the frame above the setting value. The cursor blinks and numerical value can be entered.

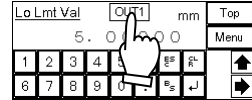

- 2 Enter the integral value using the keypad.

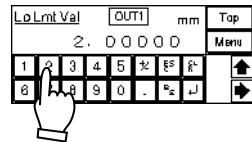

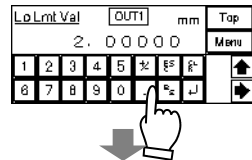

- 3 Touch the  (decimal point) key. Enter the decimal fractions.

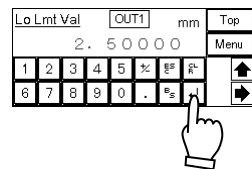

- 4 Touch the  (enter) key. This determines the value.



- * Touch the  key to cancel and quit the entry.
- * Touch the  key to clear the entry and reenter the value.
- * Touch the  key to delete the previous numerical value.

MEMO

3-2 Basic Operation

3-2-1 First Measurement

This section explains the basic operating procedures of measurement with HL-C2 Series product.

STEP1 Initial power-on

Check connection

Connect the controller, sensor head and compact programmable display.
 → “1-1 System Configuration”
 Make sure that the +24VDC power supply is connected correctly.
 → “1-4-1 Connection Method of Power Supply”
 Check the wiring of interlock.

Power-on

Laser emission starts after the system is turned on and starts up correctly.

Start-up

Check if the interlock terminal short circuits and laser control terminal is opened if laser does not light.

→ “2-1 Functions and Arrangements of I/O Terminal Block”
 Check the power supply connection if the POWER indicator does not light.

Approximately 25 to 30 seconds are required from power-on to laser emission.

Start measurement

After the programmable display starts up correctly, the measurement value display screen appears. This completes start-up procedures.

STEP2 Basic setting

Set installation mode

Select diffuse reflection mode or specular reflection mode depending on the measurement object.

→ “4-3-1 Head Setting” – “Installation Mode”

Set measurement mode

Select Diffuse [Standard] to set the diffuse reflection mode.

Select Specular [Standard] to set specular reflection mode.

→ “4-3-1 Head Setting” – “Measurement Mode”

Set function

The initial values for other settings can be used to measure the distance to the surface of measurement object.

More detailed settings enable various kinds of measurement.

→ “Chapter 4 Explanation of Functions”

STEP3 Position adjustment of sensor head

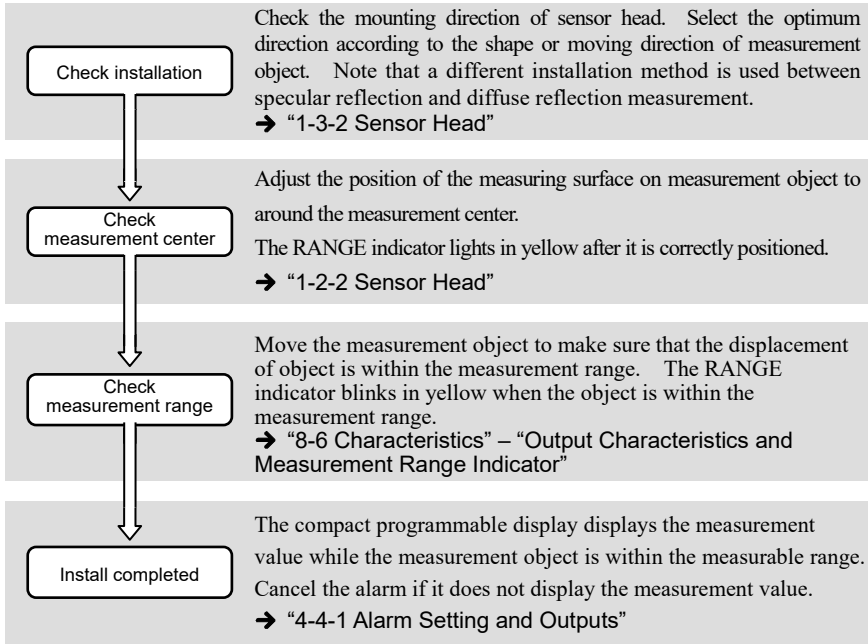

3

STEP4 Initialization

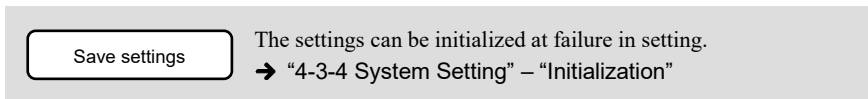

STEP5 Save settings

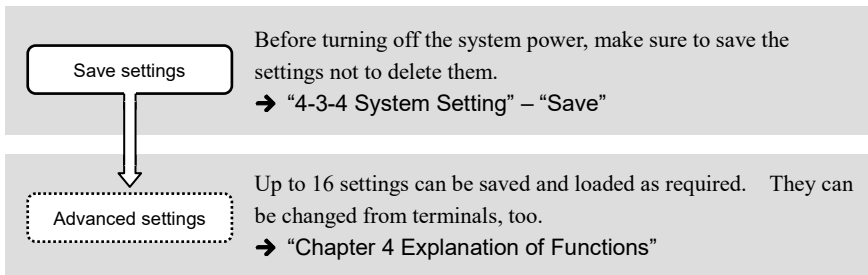

STEP6 Thickness measurement

This step explains the basic setting procedures of thickness measurement. The example below shows the procedures for thickness measurement using two sensor heads.

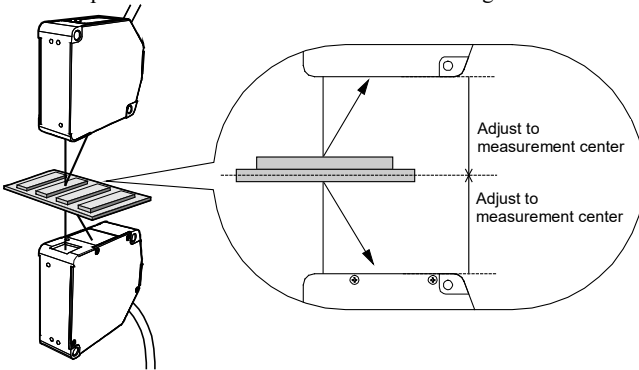

3

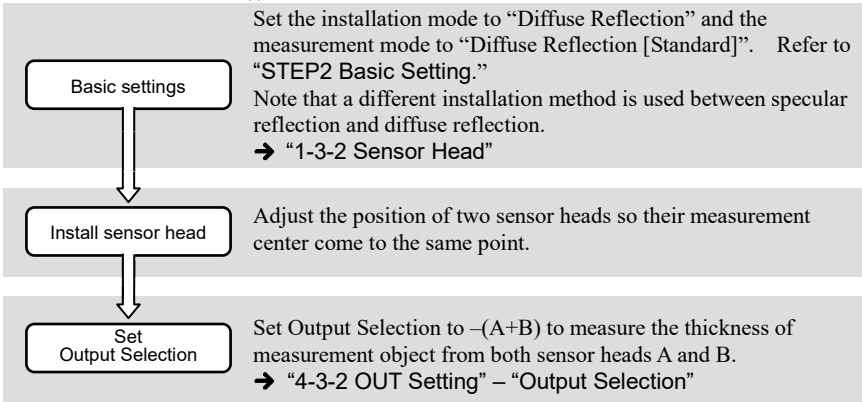

TECHNIQUE

- The difference in the measurement value between sensor head A and B, because an object is extremely different adjacent colors or materials, can be adjusted by setting Calibration function to each sensor head.
→ “4-3-1 Head Setting” – “Calibration”
- Use Zero Set function to measure the amount of displacement from the reference thickness.
→ “4-3-2 OUT Setting” – “Zero Set”
- Select the measurement mode according to the material used for stable measurement.
→ “4-3-1 Head Setting” – “Measurement Mode”
- Change the sampling cycle and moving average depending on the amount of displacement and moving speed of measurement object for stable measurement.
→ “4-3-3 Common Setting” – “Sampling Cycle” and “4-3-2 OUT Setting” – “Filter Operation”
- When using a reference measurement object, measure the object while Output Selection is set to $-(A+B)$ and then execute Zero Set. The thickness of the object is set to Offset. This makes the measurement easier.

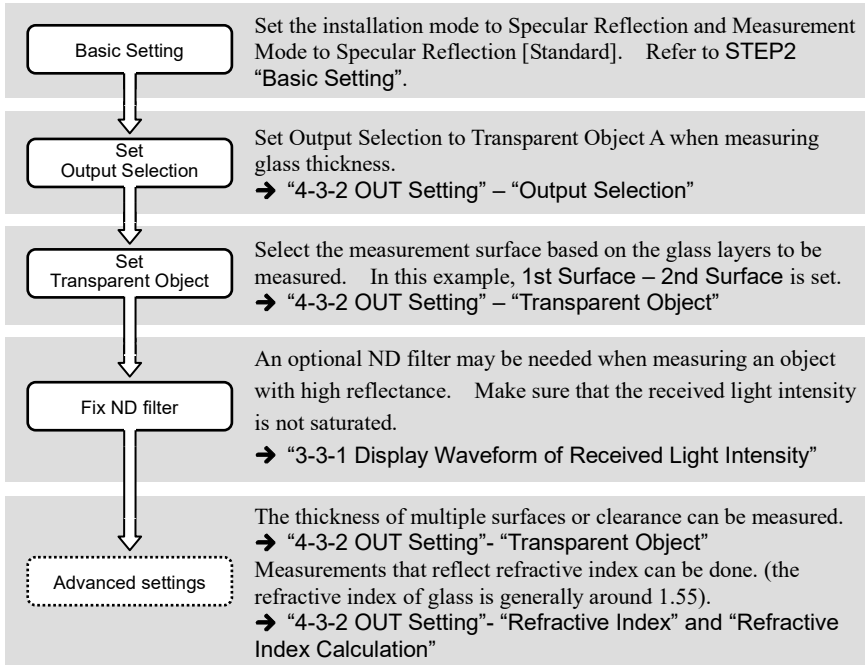
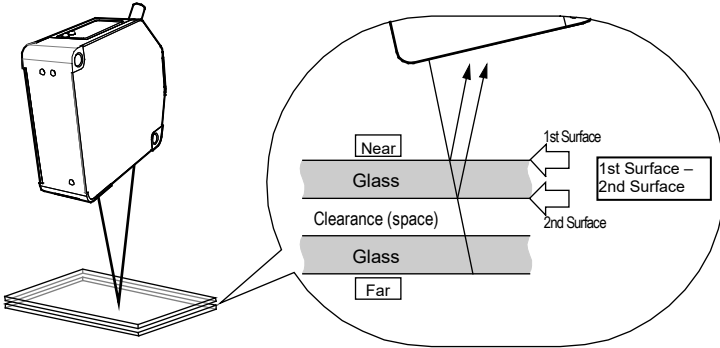
STEP7 Thickness measurement: glass material

3

TECHNIQUE

- The difference in the measurement value due to the surface state of measurement object can be adjusted by setting Calibration function.
→ “4-3-1 Head Setting” – “Calibration”
- Measurement of thin objects or that with thin clearance is available when “Glass” is selected in the Measurement Mode.
→ “4-3-1 Head Setting” - “Measurement Mode”

3-3 Screen Transition Diagram

■ Screen Flow

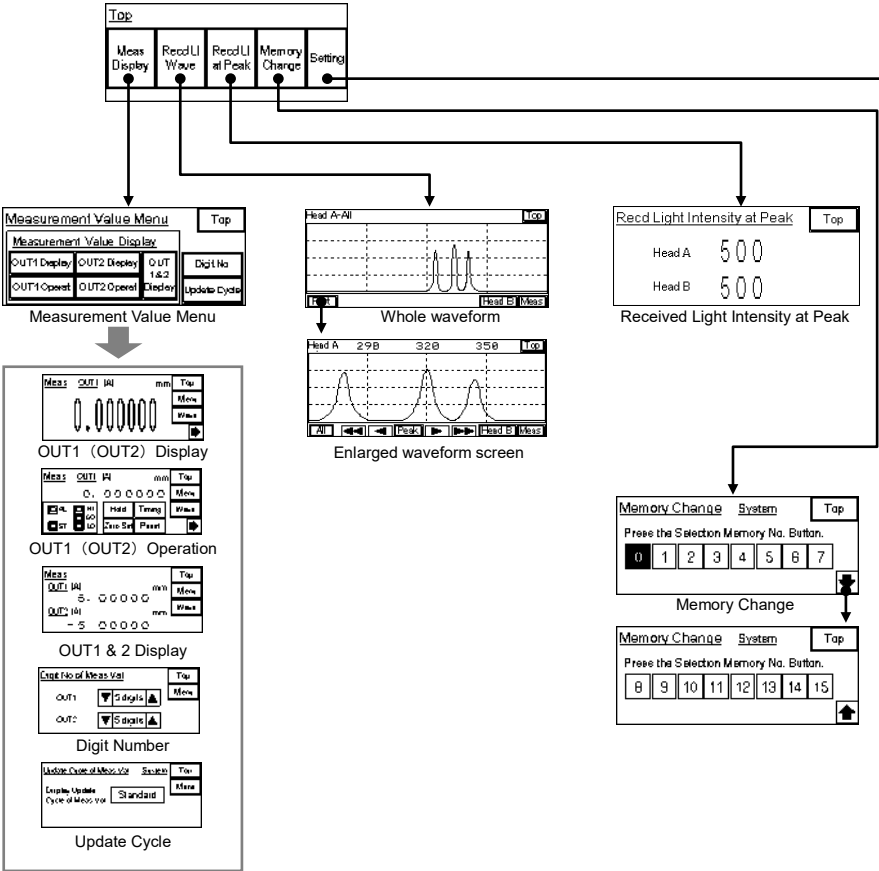

3

Setting Menu

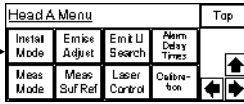
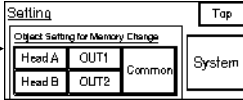

Head A

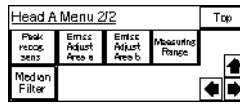

Refer to Page 3-12.

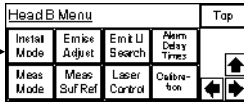

Head B

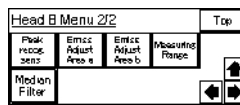

The setting items of Head B are the same as Head A.

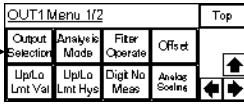

OUT1

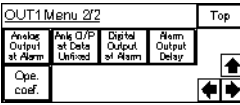

Refer to Page 3-12.

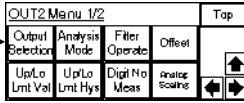

OUT2

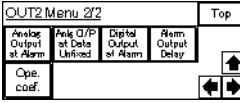

The setting items of OUT2 are the same as OUT1.

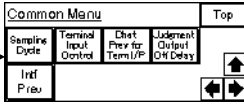

Common

Refer to Page 3-13.

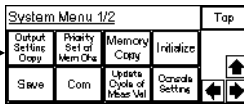

System

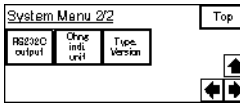

Refer to Page 3-13.



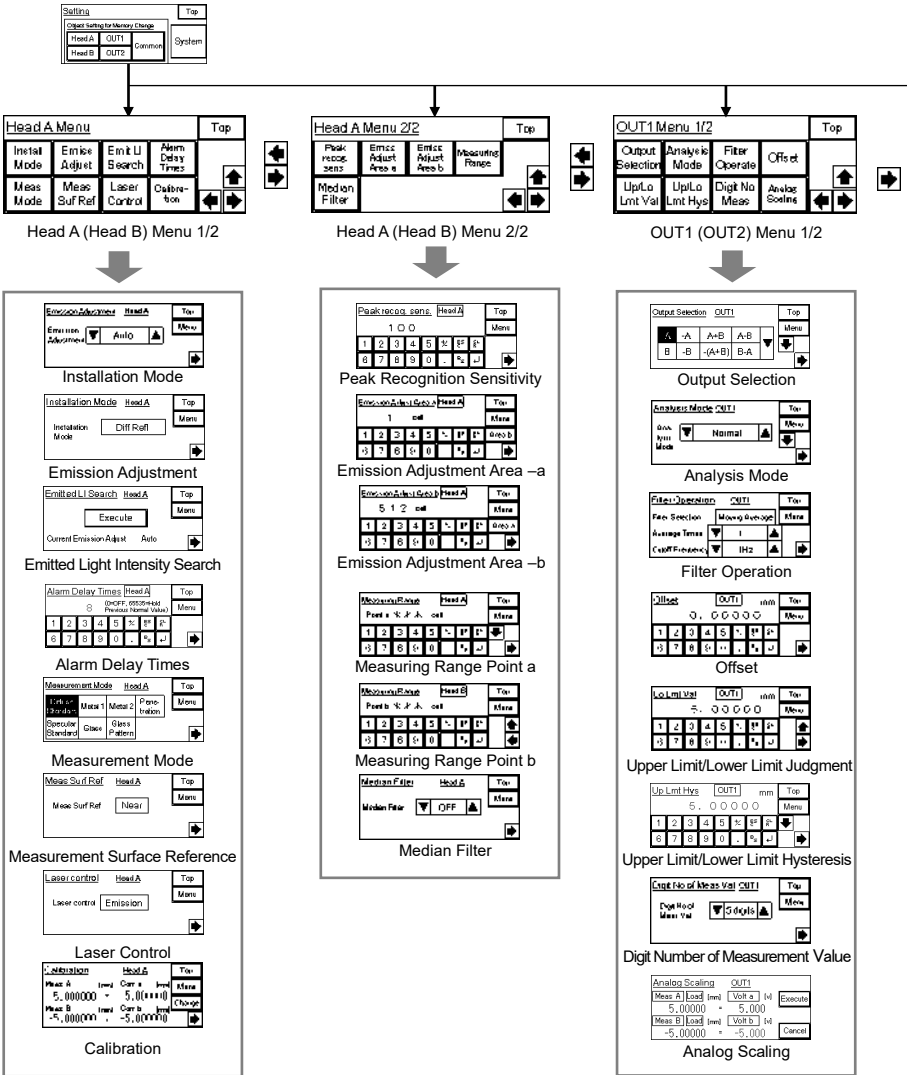

3

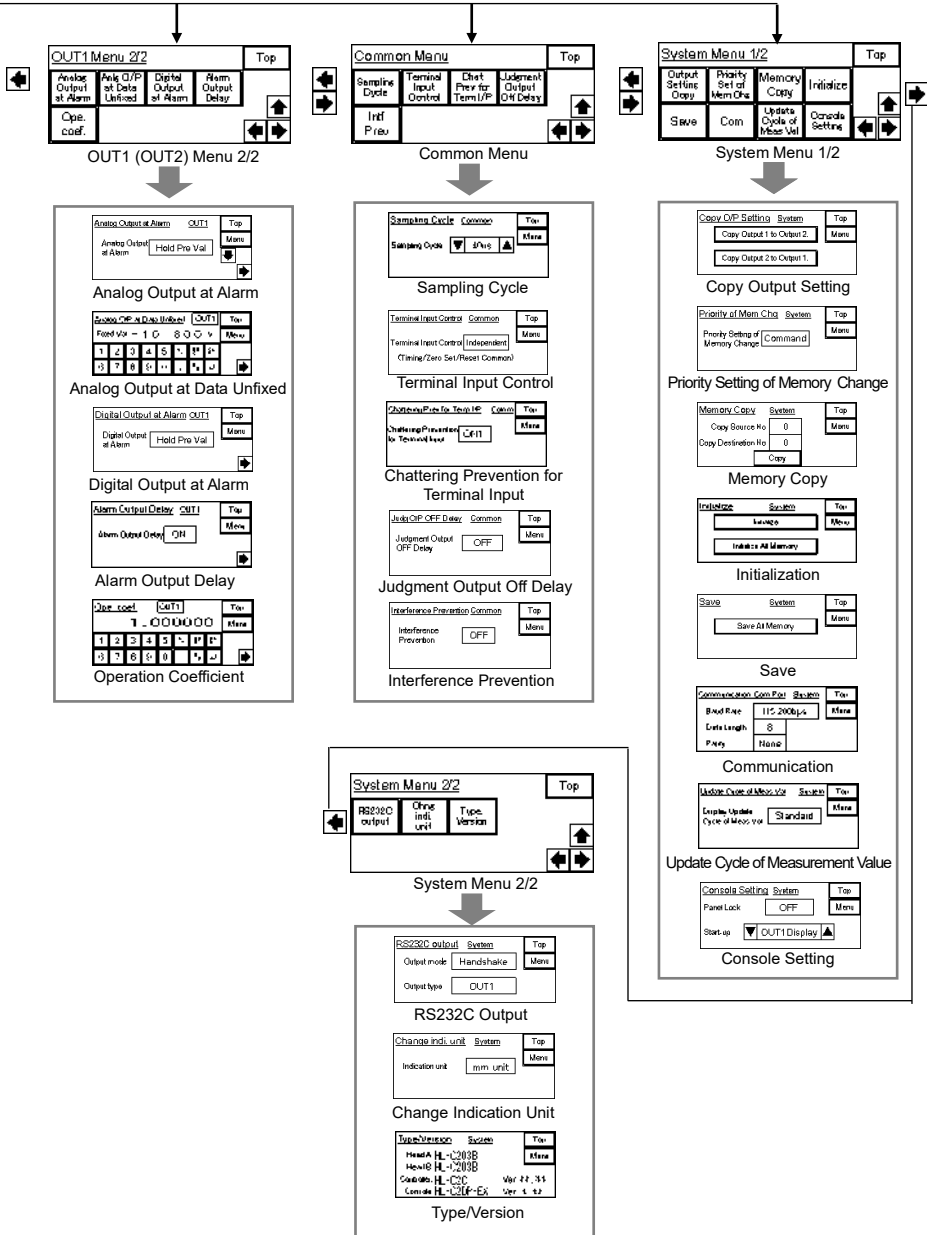

3

3-3-1 Display Waveform of Received Light Intensity

The compact programmable display can display the signal of received light intensity at Sensor Head A and B.

When the measurement object is transparent, adjust the position while viewing the waveform to make the measurement easier. In correct and accurate measurement, two peak waveforms for each surface appear in case of one panel of glass. In case of two panels of glass, four peak waveforms appear.

As shown below, the programmable display can display “whole waveform” and “enlarged waveform” screens.

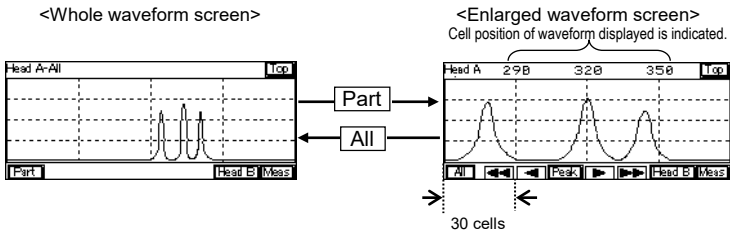

- Top** Touch the key to return to Top screen.
- Meas** Touch the key to move to Measurement Value screen.
- Head A** Touch the key to move to Sensor Head A Received Light Intensity Waveform screen.
- Head B** Touch the key to move to Sensor Head B Received Light Intensity Waveform screen.
- All** Touch the key to move to whole waveform screen.
- Part** Touch the key to move to enlarged waveform screen.
- Peak** Touch the key to find the peak point of received light intensity and display it on the center of screen.
- ▶** Touch the key to move the waveform screen display to far point by 30-cells.
- ◀** Touch the key to move the waveform screen display to near point (sensor head side) by 30-cells.
- ▶▶** Touch the key to move the waveform screen display to far point by 60-cells.
- ◀◀** Touch the key to move the waveform screen display to near point (sensor head side) by 60-cells.

3-3-2 Received Light Intensity at Peak

The screen displays the peak intensity of received light at measurement point.

If the waveform has more than one peak, the largest value of intensity is displayed. The screen also displays the state of received light intensity if an alarm occurs in the measurement range.

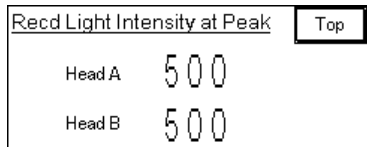

3

4

Explanation of Functions

This chapter describes various functions of the system.

4-1 Data Flow	4-2
4-2 Classification of Function	4-3
4-3 Function List & Initial Values	4-3
4-3-1 Head Setting	4-7
4-3-2 OUT Setting	4-23
4-3-3 Common Setting	4-53
4-3-4 System Setting	4-59
4-3-5 Buffering Setting	4-75
4-4 Supplemental Explanation	4-84
4-4-1 Alarm Setting and Outputs	4-84
4-4-2 Conditions When Output Data become Unfixed	4-85
4-4-3 Memory Save and Terminal Setting	4-88

4-1 Data Flow

Up to two sensor heads can be connected to the controller. Individual measurement by each of sensor head and calculation of measurement values for two sensor heads can be performed. Operation flow of each function is shown as below.

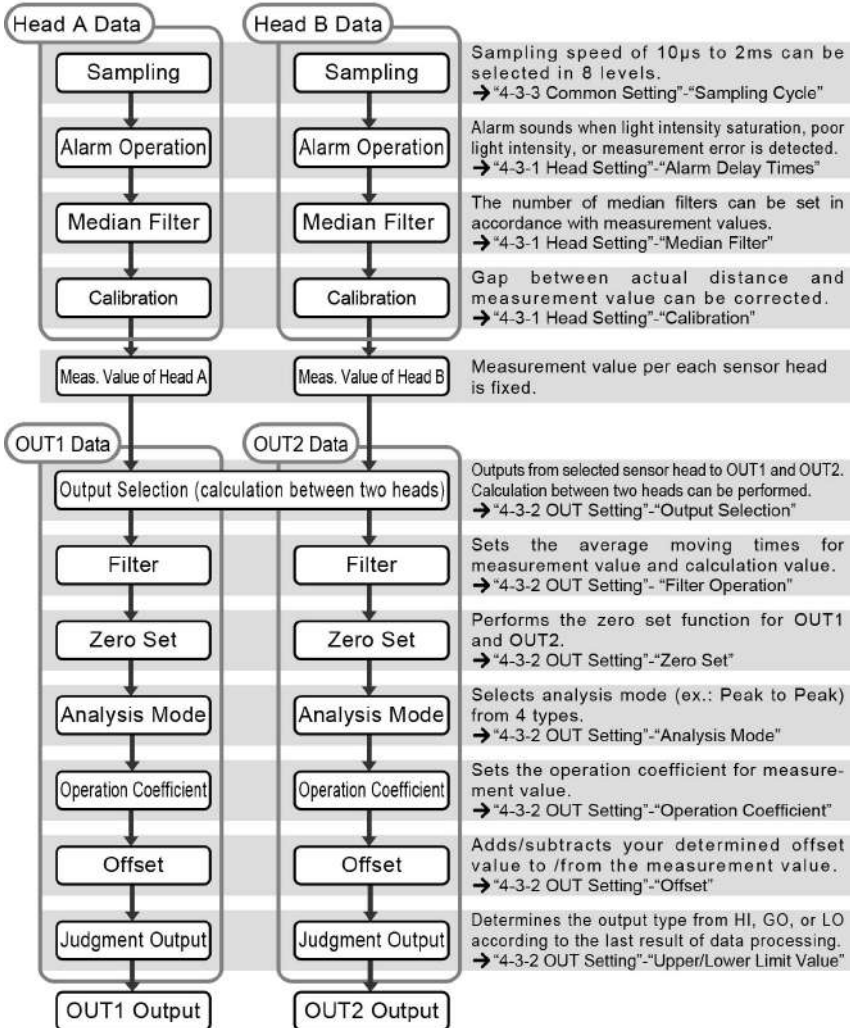

4-2 Classification of Function

In this system, all functions are classified into four categories for fixing stable measurement and various outputs.

Classification	Details
Head Setting	Function setting for stable measurement by improving accuracy of laser emission intensity
OUT Setting	Function setting related to output data processing
Common Setting	Function setting for common setting of “Head setting” and “OUT Setting”.
System Setting	System setting such as “Initialization”, “Save”, and the communication settings.

4-3 Function List & Initial Values

Class	Function	Details	Initial value	Memory change*1	Ref. page	
Head Setting	Installation Mode	Selects the measurement type from diffuse reflection or specular reflection for the target object.	Diffuse*2	○	4-7	
	Measurement Mode	Selects the most suitable digital operation type for the target object.	Diffuse [Standard]*2	○	4-8	
	Emission Adjustment	Sets the optimum emitted light intensity for the measurement area.	AUTO	○	4-10	
	Emission Adjustment Area	Area-a	This function specifies an emission auto adjustment area.	1	○	4-11
		Area-b		512		
	Emitted Light Intensity Search	Searches the received light intensity of all measurement surfaces and sets the optimum intensity automatically.	AUTO	X	4-13	
	Alarm Delay Times	Holds the previous normal value up to the set number of times during alarm operation.	8	○	4-14	
	Measurement Surface Reference	Selects the counting method of the surface which is set at “Output Selection”.	Near	○	4-15	
	Measuring Range	Point a	A given range can be specified for measurement.	3	○	4-16
		Point b		510		
Laser Control	Switches emission/stop of laser.	Emission	○	4-18		

*1 Memory Change ○ : Maximum 16 settings can be saved by performing memory change.

X : Settings can not be changed by performing memory change.

*2 When the initialization is performed with 10mm type (HL-C201A) connected, the default of the installation mode is **specular reflection**, the default of the measurement mode is **specular reflection [standard]**.

Class	Function		Details	Initial value	Memory change*1	Ref. page
Head Setting	Calibration	Measurement value A	Corrects the measurement value to the measurement object's color, material, surface condition.	Upper measurement limit (positive number)	○	4-19
		Correct value a		Upper measurement limit (positive number)		
		Measurement value B		Lower measurement limit (negative number)		
		Correct value b		Lower measurement limit (negative number)		
	Peak Recognition Sensitivity		Sets the peak of the received light waveform and the recognition level.	100	○	4-21
	Median Filter		Cut off sudden changes in measurement values in order to prevent variation in measurement.	OFF	○	4-22
OUT Setting	Output Selection		Selects whether measurement is individually performed by each sensor head or performed by two sensor heads with various calculation.	OUT1:A OUT2:B	○	4-23
	Transparent Object		Selects the measurement surface from several surfaces existed in the transparent object.	1 st surface	○	4-25
		Refractive Index calculation	Reflects the refractive index, which is set at "Refractive Index", to the measurement result.	OFF	○	4-27
		Refractive Index	Sets the refractive index for measuring transparent object.	1.000000	○	4-29
	Zero Set		Forcibly sets the measurement value to "0".	OFF	○	4-31
	Timing		Holds the measurement value display of compact programmable display and analog output.	OFF	X	4-33
	Reset		Resets the measurement value.	OFF	X	4-34
	Hold		Stops updating the measurement value display.	OFF	X	4-35
	Analysis Mode		Sets the analysis mode.	Normal	○	4-36
	Filter Operation		Selects the moving average, low-pass, or high-pass.	Moving average	○	4-37
	Average Times		Sets the average number of times of moving average.	512 times	○	
	Cutoff frequency		Sets the cutoff frequency of the low-pass/high-pass filter.	100Hz	○	
	Operation Coefficient		Sets the operation coefficient for the measurement value.	1.000000	○	4-39
	Offset		Adds/subtracts the offset value to/from the measurement value.	0.00000mm	○	4-40
Judgment Output	Upper Limit value	Sets upper/lower limit value for judging the measurement value.	Upper measurement limit (positive value)	○	4-41	
	Lower Limit Value		Lower measurement limit (negative value)			
	Upper Limit Hys.	Stabilizes the judgment output for chattering.	0.1% of the meas. range	○	4-43	
	Lower Limit Hys.		0.1% of the meas. range			
Analog Scaling	Meas. Val A	Performs scaling the analog voltage output to any desired value.	Upper meas. limit (positive val.)	○	4-45	
	Voltage a		+5[V]			
	Meas. Val B		Lower meas. limit (positive val.)			
	Voltage b		-5[V]			

*1 Memory Change ○: Maximum 16 settings can be saved by performing memory change.

X: Settings can not be changed by performing memory change.

Class	Function	Details	Initial value	Memory change*1	Ref. Page
OUT Setting	Analog Output at Alarm	Sets the analog output status at alarm operation.	Hold previous value	○	4-48
	Fixed Value	Fixes the analog output status at alarm operation.	+10.800[V]	○	
	Analog Output at Data Unfixed	Sets the analog output status at data unfixed.	-10.800[V]	○	4-49
	Digital Output at Alarm	Sets the digital output status at alarm operation.	Hold previous value	○	4-50
	Alarm Output Delay	Retards output from the alarm terminal.	ON	○	4-51
	Digit Number of Measurement Value	Sets the display digits number of measurement value on compact programmable display.	5 digits	○	4-52
Common Setting	Analog Output at Data Unfixed	Sets the analog output status at data unfixed.	-10.800[V]	○	4-49
	Sampling Cycle	Sets the sampling cycle for measurement.	40μs	○	4-53
	Terminal Input Control	Sets that two sensor heads can be operated by one terminal input.	Independent	○	4-55
	Chattering Prevention for Terminal Input	Prevents chattering of terminal input.	ON1	○	4-56
	Judgment Output Off Delay	Delays the timing of switching ON to OFF of the judgment output.	OFF	○	4-57
	Interference Prevention	Prevents interference between 2 sensor heads.	OFF	○	4-58
System Setting	Display Update Cycle of Measurement Value	Sets the update cycle of measurement value display.	Standard	☆	4-59
	Change Indication Unit	Changes the indication unit of the measurement value on compact programmable display.	mm unit	☆	4-61
	Copy Output Setting	Copies the setting contents of "OUT Setting" between memories.		X	4-62
	Priority Setting of Memory Change	Sets the terminals and commands.		☆	4-63
	Memory Change	Changes memory for saving the setting contents.		☆	4-64
	Memory Copy	Copies the saved contents in a memory to another memory.		X	4-65
	Initialization	Initializes the memory settings in current using.		X	4-66
	Initialize All Memory	Initializes all memory settings.			
	Save	Saves all memory settings.		X	4-68
	Communication: COM Port	Sets RS-232C communication.		☆	4-69
Baud Rate	Sets the communication speed.	115200bps			
Data Length	Sets the number of bits of data.	8bit			
Parity	Sets the parity.	None			

*Memory Change ○: Maximum 16 settings can be saved by performing memory change.

X: Settings cannot be changed by performing memory change.

☆: Settings are saved as common settings of all memories. Settings per each memory cannot be executed.

Class	Function	Details	Initial value	Memory change*	Ref. page
System Setting	RS-232C Output	Makes the settings of the measurement data output for RS-232C communication.		☆	4-70
	RS-232C Output Mode	Sets the output mode of the measurement data.	Handshake		
	RS-232C Output Type	Sets the output type of the measurement data.	OUT1		
	Console Setting	Performs various settings for compact programmable display.		☆	4-72
	Panel Lock	Prevents any error settings due to misoperation of compact programmable display.	OFF		
	Start-up Screen	Selects the next displaying screen after wake-up screen of compact programmable display.	OUT1 Display Screen		
Buffering Setting	Self-stop	Stops buffering operation automatically.	OFF	X	4-77
	Buffering Mode	Loads the measurement data to PC by accumulating the data in the controller.	Continuous mode	X	4-77
	Buffering Type	Selects the accumulating output.	OUT1	X	4-79
	Buffering Rate	Loads the measurement data for a long-duration by decimating the measurement data during data accumulation.	1	X	4-79
	Accumulation Amount	Sets the accumulation data amount.	20000 data	X	4-79
	Trigger Conditions	Sets the conditions of trigger generation.	At timing input on	X	4-80
	Trigger Delay	Delays the timing of accumulation after the trigger generation.	0	X	4-81
	Trigger Point	Sets the trigger generation position in the accumulated data.	10000	X	4-81
	Sample Trigger Accumulation Amount	Sets the accumulation data amount at every trigger generation.	1	X	4-81
	Status Readout	Checks the operation status of accumulation.		X	4-82
	Last Data Point	Reads out the accumulation status from the measurement data amount.		X	4-82
	Data Read	Reads out the accumulated data.		X	4-83

*Memory Change ○: Maximum 16 settings can be saved by performing memory change.

X: Settings cannot be changed by performing memory change.

☆: Settings are saved as common settings of all memories. Settings per each memory cannot be executed.

4-3-1 Head Setting

■ Installation Mode

Measurement type can be selected from the **diffuse reflection** and **specular reflection** according to the kind of measurement object.

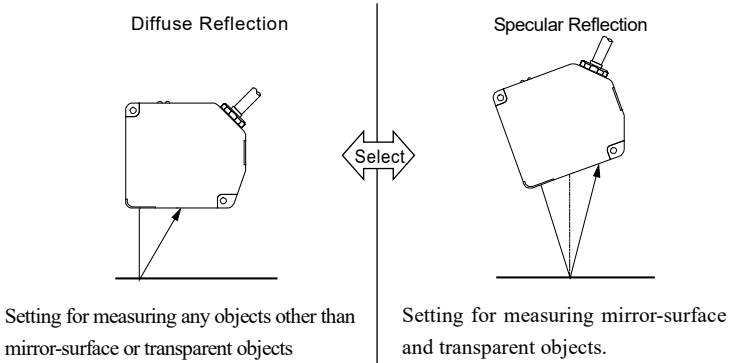

✎ Supplemental remarks

Diffuse reflection is set as a default. Be sure to set to “Specular reflection” when measuring a mirror-surface or transparent object.

Note that the mounting angle is different between the diffuse reflection and the specular reflection.

Refer to →“1-3 Installation Method” for proper installation. If the settings or installation are not correct, accurate data cannot be acquired.

❗ CHECK

In case that the initialization is done by connecting 10mm type (HL-C201A), the default is set to “specular reflection”.

● How to Use

1 Display the “Installation Mode” screen.

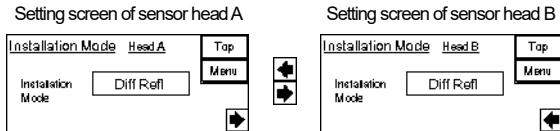

2 Touch “Installation Mode” key to select the installation mode.

The display changes between **Diff Refl** and **Spec Refl** by touching the key.

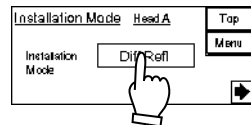

■ Measurement Mode

The optimum digital processing type can be selected to measurement object types.

The measurement mode is a function for selecting the optimum measurement algorithm such as unbalance correction of received light waveform. Select the optimum measurement mode depending on the material of target or application purpose to get the stable measurement value. The below list shows all measurement modes and their details.

Setting item	Purposes & Applications	Effects	Recommended setting
Diffuse Reflection [Standard]	· Any objects other than mirror-surface or transparent objects · Metal, resin, ceramic, etc.	Standard setting suitable for many applications. Try this setting at first.	Diffuse Reflection
Metal 1	· Hairline finished metal · Extrusion, rolled material, etc	Reduces the variation of measurement value caused from the metal surface effects.	
Metal 2	· Hard hairline finished metal · Materials with tiny scratch, cutting mark, grinding mark	Enhances the effect in “Metal 1” mode.	
Penetration	· Half transparent objects · Half transparent resin	Reduces penetration of laser light to a target object.	
Specular Reflection [Standard]	· Mirror surface or transparent objects · Front and back surface of glass	Standard setting for measurement at specular reflection installation. Try this mode at first.	Specular Reflection
Glass	· Clearance of glass, thickness	Performs measurement on thinner clearance than normal clearance.	
Glass Pattern	· Pattern glass	Reduces the variation of measurement value due to different refractive index.	

* “Hairline” means the metal finishing with detailed continuous line patterns on its surface.

❗ CHECK

- Select appropriate “measurement mode” for your application by actually performing measurement.
- Regardless of “Installation Mode (specular or diffuse reflection)”, any measurement mode can be selected.

- How to use

1 Display the “Measurement Mode” screen.

Setting screen of sensor head A

Measurement Mode		Head A		Top
Diffuse Standard	Metal 1	Metal 2	Penetration	Menu
Specular Standard	Glass	Glass Pattern		

Setting screen of sensor head B

Measurement Mode		Head B		Top
Diffuse Standard	Metal 1	Metal 2	Penetration	Menu
Specular Standard	Glass	Glass Pattern		

- ## 2 Touch the appropriate measurement mode key to a target object.

Measurement Mode		Head A		Top
Diffuse Standard	Metal 1	Metal 2	Penetration	Menu
Specular Standard	Glass	Glass Pattern		

■ Emission Adjustment

This function sets an appropriate emitted light intensity to a measurement object. AUTO is set as a default. “AUTO” automatically sets optimum emitted light intensity to meet the reflection light amount of the measurement target.

When the function is set to “AUTO”, the current light intensity is displayed in percent figures.

In case that “Emission Adjustment” is set to “Fixed”, set the value to approximately 600 to 700 while checking “Received Light Intensity Waveform Display” or “Received Light Intensity at Peak” of compact programmable display and Intelligent Monitor AiM.

❗ CHECK

Normally set the emission adjustment function to AUTO for use.

TECHNIQUE

To measure the objects where light reflection may vary excessively, such as on an object having many holes or a connector pin in which light-shielding status and light-passing status may be repeated, alarm status may continue due to delayed feedback. In this case, for increasing the measurement speed, fix the appropriate light intensity to the measurement point.

The laser light reflection intensity excessively varies depending on the mounting condition of the sensor head, the surface condition or refractive index of the measurement object. If the settings of “Emission Adjustment” is not sufficient, change the “Sampling Cycle” for acquiring appropriate received light intensity.

When the measurement is executed with the sensor head mounted in specular reflection and the refractive index of the measurement object is high, the setting of the emission adjustment is not sufficient due to the excessive light reflection intensity. In this case, install ND filter unit (optional).

● How to use

1 Display the “Emission Adjustment” screen.

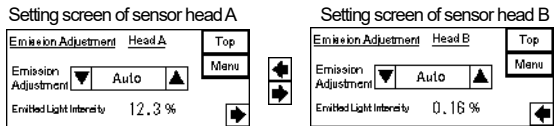

2 Set the emission intensity by ▲▼ key.

The below shows the light intensity of 31 levels of the setting value.

Set.value	Emitted light intensity
AUTO	AUTO
0.04%	fixed
0.05%	fixed
0.06%	fixed
:	
:	
59.2%	fixed
76.9%	fixed
100%	fixed

Low

High

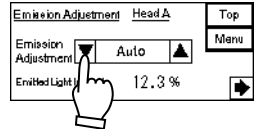

■ Emission Adjustment Area

This function specifies an emission auto adjustment area. The light intensity feedback function operates between the two cells from starting cell to ending cell.

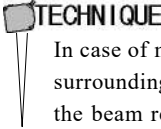

TECHNIQUE
In case of measuring a transparent object where the high reflectance in the surrounding affects the emission, it is possible to adjust the emission on the beam receiving surface you wish to detect by specifying an emission adjustment area.

Emission Adjustment Area specifies two light receiving cells of Area-a and Area-b. The light intensity feedback function works so that the light received intensity is optimal among the specified areas. Area-a and Area-b are set in the range from 1 to 512 respectively.

❶ CHECK

- This is valid when Emission Adjustment is selected as “Auto”.
- In case the sampling cycle is set to 10 μ s, set Area-a and Area-b in the range of 1 to 112 respectively.
- In case the sampling cycle is set to 20 μ s, set Area-a and Area-b in the range of 1 to 256 respectively.
- The magnitude relation between Area-a and Area-b is automatically determined by the controller. However, do not set the two to the same value.
- In case the setting range of the specified area is not appropriate, light will be emitted at 100% fixed and measurement alarm will go off.

● How to use

1 Display the “Emission Adjustment Area –a” screen.

Setting screen of sensor head

Emission Adjust Area a										Head A		Top	
1										cell		Menu	
1	2	3	4	5	1/2	1/4	1/8	1/16	1/32	Area b			
8	7	8	9	0	.	%	↵					▶	

Area a Area b

Emission Adjust Area b										Head A		Top	
5 1 2										cell		Menu	
1	2	3	4	5	1/2	1/4	1/8	1/16	1/32	Area a			
8	7	8	9	0	.	%	↵					▶	

Setting screen of sensor head

Emission Adjust Area a										Head B		Top	
1										cell		Menu	
1	2	3	4	5	1/2	1/4	1/8	1/16	1/32	Area b			
8	7	8	9	0	.	%	↵					▶	

Area a Area b

Emission Adjust Area b										Head B		Top	
5 1 2										cell		Menu	
1	2	3	4	5	1/2	1/4	1/8	1/16	1/32	Area a			
8	7	8	9	0	.	%	↵					▶	

2 Touch **Head A** (or **Area B**) in order to input the values.

3 Touch the number keys to specify the area.

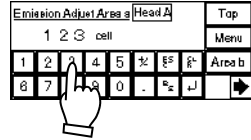

4 Touch **↵** key to decide on the specified area.

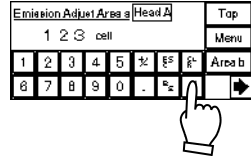

■ Emitted Light Intensity Search

This function searches the received light intensity of a measurement surface and sets the appropriate emitted light intensity automatically.

TECHNIQUE

Set this function when measuring the thickness of a transparent object with low received light. Without this function, “Emission Adjustment” function automatically optimizes the emitted light intensity based on another objects or surfaces with high received light. This results in failure of optimizing the emitted light intensity for any low-reflectance objects. This function is useful for measuring the setting surfaces at “Output Selection”.

To optimize the received light intensity of an object with the least light intensity among the all setting received light surfaces at “Output Selection”, determine the emitted light intensity of it from the fixed value of 31 levels and change the setting.

After the completion of “Emitted Light Intensity Search”, the optimum value will be displayed within “0.04% fixed to 100% fixed”. If the search is failed, “Emission Adjustment” is set to “AUTO”.

! CHECK

When changing the initial setting of “Output Selection”, perform it before starting the emitted light intensity search. →Refer to “4-3-2 OUT Setting”-“Output Selection”.

This searches the emission intensity in all areas regardless of the setting of emission adjustment area.

● How to use

1 Display the “Emitted LI Search” screen.

Execution screen of sensor head A

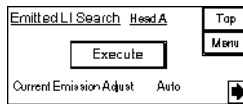

Execution screen of sensor head B

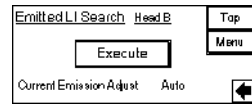

2 Touch the **Execute** key to execute the “Emitted LI Search”.

The right screen appears during emitted light intensity search. After the completion of the search, the below screens appear depending on the result.

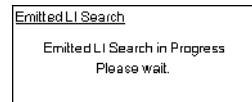

When Search was completed.

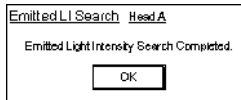

When search was failed.

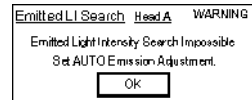

3 Touch **OK** key.

The start screen of the step 1 appears again. On the screen, the current “Emission Adjustment” value can be confirmed.

When the search has been failed, the “Emission Adjustment” is set to “AUTO”.

■ Alarm Delay Times

This function holds the previous (latest) normal value up to the setting number of times when an alarm is issued.

This function relates to the digital measurement value, analog output, alarm terminal output, controller alarm indicator under an alarm status.

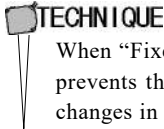

When “Fixed value” is set at the “Analog Output at Alarm”, this function prevents the fixed outputting of an instantaneous alarm status due to the changes in the surface condition of the measurement object.

When an alarm is issued (due to insufficient light intensity, or when a measurement object is not in the measurement range), the previous normal value is on hold up to the setting number of times at this function.

If the alarm exceeds the setting number of times, the fixed value that has been set at “Analog Output at Alarm” or “Digital Output at Alarm” is output.

However, when the “Hold Previous Value” has been selected at “Analog Output at Alarm” or “Digital Output at Alarm”, the alarm output is on hold during the alarm status irrespective to the alarm delay number of times.

🔍 REFERENCE

For the alarm terminal output, irrespective to this setting, the “Alarm Output Delay Function” can reflect the alarm status to the measurement in real-time.

• How to use

1 Display the “Alarm Delay Times” screen.

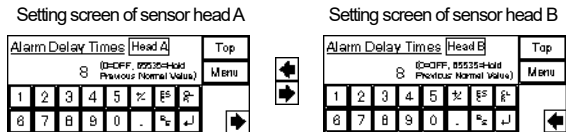

2 Touch **Head A** (or **Head B**) and enter the setting value.

3 Set the alarm delay times by touching numerical key.

Set “0” to turn off the function, and set “65535” when the previous normal value is on hold.

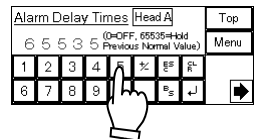

4 Touch the **Enter** key to confirm the setting number of times.

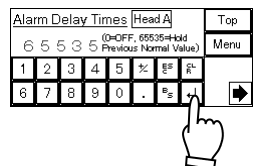

■ Measurement Surface Reference

This function selects the counting reference of the setting surface at “Output Selection”.

Before measuring a transparent object, select the measurement surface reference from “Near Setting” (counting the layer of the measurement surface which is set at “Output Selection” from the nearest surface to the farthest surface) or “Far Setting” (counting the layer from the farthest surface to the nearest surface) as shown below.

TECHNIQUE

The measurement surfaces can be recognized accurately only when they are within the measurement range of the sensor head.

Thus, if one of them goes off the measurement range due to movement of the sensor head or the measurement object, the actual measurement point may also be moved from the setting point. In this case, set the “Measurement Surface Reference” with concerning the moving area of the sensor head or the measurement object to prevent a detection error.

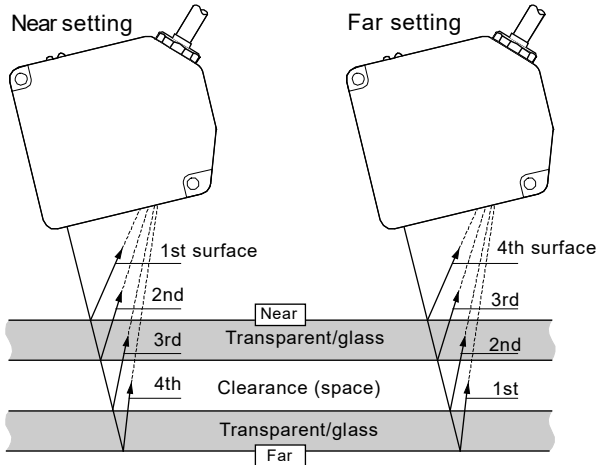

● How to use

1 Display the “Meas Surf Ref” screen.

Setting screen of sensor head A

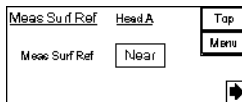

Setting screen of sensor head B

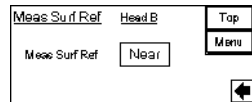

2 Select the measurement surface reference.

The key display is changed between **Near** and **Far** each time the key is touched.

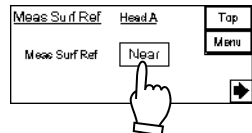

■ Measuring Range

A given range can be specified for measurement.

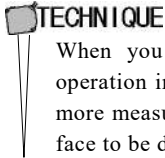

When you want to measure thickness, etc. of a transparent object, operation in “Output selection” becomes impossible if there are seven or more measurement faces. Measurement becomes possible by specifying a face to be detected in measuring range specification.

In order to set a measuring range, specify the positions of two light receiving cells (Measuring Point a and Measuring Point b). The area in between the specified two points are set as the measuring range, and other areas are excluded from measurement.

Measuring Point a and Measuring Point b should be respectively set between 3 and 510.

Check the received light wave pattern indications on the compact programmable display and on the Intelligent Monitor AiM.

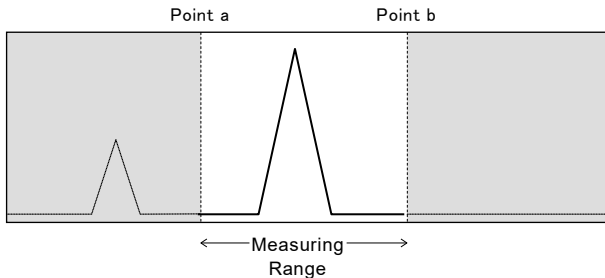

❗ CHECK

- The relative sizes of Measuring Point a and Measuring Point b are automatically determined by the controller. Do not use the same value for two points.
- When the sampling cycle is set to 10 μs , set Measuring Point a and Measuring Point b respectively between 3 and 112.
- When the sampling cycle is set to 20 μs , set Measuring Point a and Measuring Point b respectively between 3 and 256.
- When a specified measuring range is inappropriate, the light emission level is fixed to 100%, and a measurement alarm is issued.

- How to use

1 Display the “Measuring Range” screen.

Setting screen for Sensor Head A

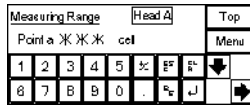

Setting screen for Sensor Head B

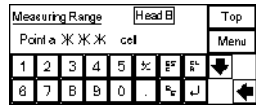

- ## 2 Switch between “Measuring Point a” and “Measuring Point b” by touching the keys.

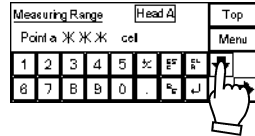

- ## 3 Touch Head A (or Head B) and enter the setting value.

- ## 4 Specify the area by touching the numeric keys.

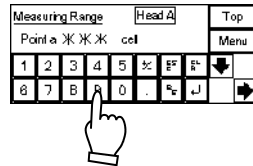

- ## 5 Enable the specified area by touching the key.

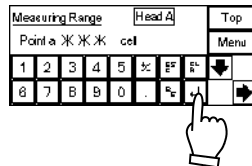

4

■ Laser Control

This function switches ON/OFF of the laser emission.

With this function, laser emission, that is unnecessary except at measurement, can be stopped.

❗ CHECK

- While the laser emission stop is input (with LSRA and LSRB short-circuited) from the laser control terminal of the controller, the setting there influences this function. In that case, this function is invalid (due to the priority of the laser terminal input).
- When the laser control is set to “Stop” and then set to “Emission”, the system becomes the data unfixed status temporarily. The strobe output is set to “OFF” under the data unfixed status. After recovered from the data unfixed status, the strobe output is set to “ON” and the analog output and the measurement value display are started. (Refer to →“2-5 Timing Chart”.)
- The laser emission is not started by setting the laser control to “ON” while the laser emission OFF (IL is released) is set at the remote interlock function.

4

● How to use

1 Display the “Laser Control” screen.

Setting screen of sensor head A

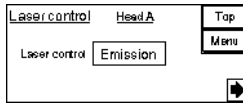

Setting screen of sensor head B

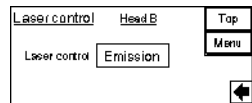

2 Touch the “Laser Control” key and changes the setting.

The key display is changed between **Emission** and **Stop** each time the key is touched.

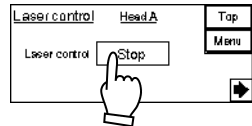

■ Calibration

This function corrects the deviation of the measurement value caused from the color, material, or surface condition of the measurement object.

As shown below, the value can be corrected by setting two points of “a” and “b” respectively to the point “A” and “B”. The point “A” means the actual measurement value, and the point “a” means the correction value. The point “B” and the correction value “b” can be set as same as the above.

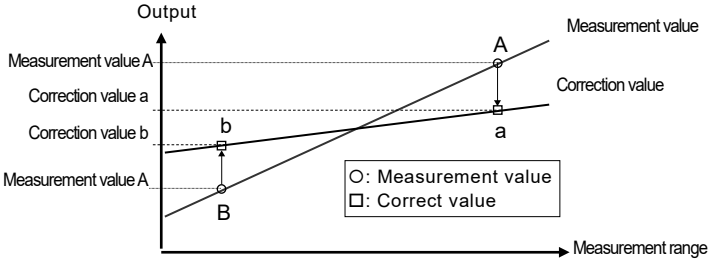

❗ CHECK

Before setting the calibration, be sure that the timing input, offset, and zero set is set to “OFF”, the analysis mode is set to “NORMAL”, OUT1 is set to “A” and OUT2 is set to “B” for the output selection. Then, perform the calibration setting in the appropriate measurement mode.

● How to use

1 Display the “Calibration” screen.

Setting screen of sensor head A

Calibration		Head A		Top
Meas A	(mm)	Corr a	(mm)	Menu
5.000000	=	5.000000		Change
Meas B	(mm)	Corr b	(mm)	
-5.000000	=	-5.000000		

Setting screen of sensor head B

Calibration		Head B		Top
Meas A	(mm)	Corr a	(mm)	Menu
5.000000	=	5.000000		Change
Meas B	(mm)	Corr b	(mm)	
-5.000000	=	-5.000000		

2 Touch the **Change** key.

The screen is changed.

Calibration		Head B		Top
Meas A	(mm)	Corr a	(mm)	Menu
5.000000	=	5.000000		Change
Meas B	(mm)	Corr b	(mm)	
-5.000000	=	-5.000000		

Touch each key to change the screen.

Key	Screen
Meas A	--- Measurement value A input screen
Corr a	--- Correction value a input screen
Meas B	--- Measurement value B input screen
Corr b	--- Correction value b input screen
Load (top)	--- Measurement value A load screen
Load (bottom)	--- Measurement value B load screen

Calibration		Head A		
Meas A	Load (mm)	Corr a	(mm)	Execute
5.000000	=	5.000000		
Meas B	Load (mm)	Corr b	(mm)	
-5.000000	=	-5.000000		Cancel

→ For inputting the measurement value or correction value

→ For loading the measurement value from the current value

3 Set/change the measurement value or correction value.

For setting or changing method of the measurement value and correction value, refer to “For inputting the measurement value or correction value” and “For loading the measurement value from the current value”.

4 Touch the **Excute** key.

*Touch the **Cancel** key to cancel changing the value.

Calibration starts with the setting value.

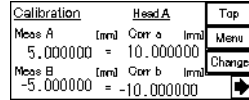
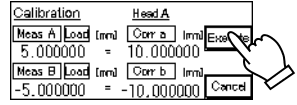

For inputting the measurement value or correction value

1 Touch the **Meas A**, **Meas B**, **Corr a**, or **Corr b** key to be input.

The screen for inputting the setting value appears.

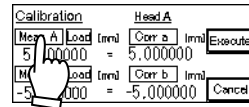

2 Input the setting value (1), then, touch the **↵** key (2) to confirm the setting.

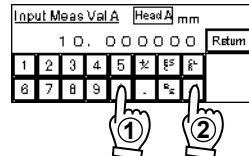

3 Touch the **Return** key to return to the step1 screen.

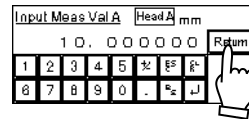

For loading the measurement value from the current value

1 Touch the **Load** key.

The screen for loading the measurement value appears.

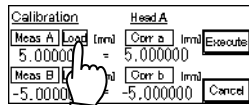

2 Touch the **Load Meas Val A from Curr val.** key.

The measurement value is loaded from the current value.

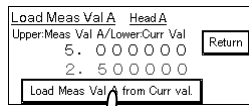

3 Touch the **Return** key to return to the step1 screen.

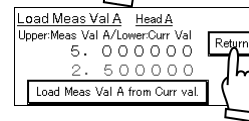

❶ CHECK

The setting contents of the output selection for OUT setting are reflected in the current value. Set OUT1 to “A” and OUT2 to “B” for the output selection.

■ Peak Recognition Sensitivity

This function sets the peak of the received light waveform and the peak recognition level.

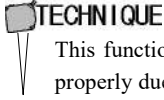

This function is effective when you cannot acquire the measurement value properly due to waveform instability.

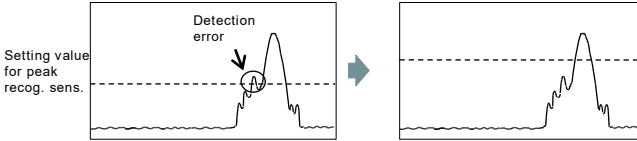

❗ CHECK

Setting range is 100 to 400. The initial value is set to 100.

● How to use

1 Display the “Peak Recog. Sens.” Screen.

Selection screen of sensor head A

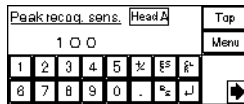

Selection screen of sensor head B

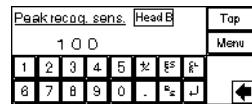

2 Set the peak recognition sensitivity.

- (1) Touch the **Head A** (**Head B**) key to make the numerical value input possible.
- (2) Input the numerical value.
- (3) Touch the **⊞** key to confirm the value.

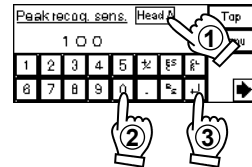

■ Median Filter

Cut off changes in measurement values in order to prevent variation in measurement.

The setting of median filter can be selected from “OFF”, “7 points”, “15 points” and “31 points”.

Median filter is effective to cut off sudden changes in measurement values.

Ex

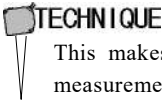
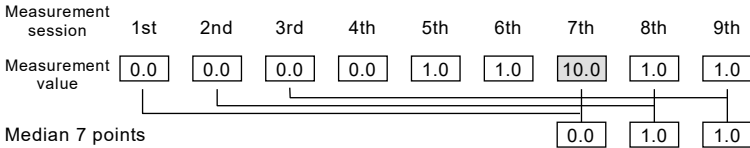

This makes it possible to cut off spike values, while maintaining the measurement of steps and edges in measured shapes.

❗ CHECK

- When the sampling cycle is set to 10 μ s or 20 μ s, set the median filter to “OFF”. An alarm is issued if a setting other than “OFF” is selected.

• How to use

- 1 Display the “Median Filter” screen.

Setting screen for Sensor Head A

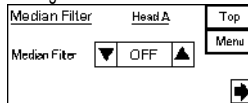

Setting screen for Sensor Head B

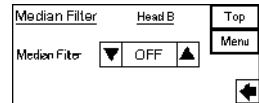

- 2 Switch between different settings of median filter by touching the keys. Settings are switched every time you touch the keys.

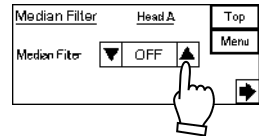

4-3-2 OUT Setting

■ Output Selection

This function selects the output pattern of measurement values.

The below list shows the setting items and the output details.

Setting item	Function
A	Outputs the measurement value of the sensor head A.
B	Outputs the measurement value of the sensor head B.
-A	Outputs the measurement value of the sensor head A with putting a negative sign.
-B	Outputs the measurement value of the sensor head B with putting a negative sign.
A+B	Adds the measurement values of the sensor heads A&B and outputs the value.
-(A+B)	Adds the measurement values of the sensor heads A&B and outputs the value with putting a negative sign.
A-B	Subtracts the measurement value of the sensor head B from that of sensor head A and outputs the value.
B-A	Subtracts the measurement value of the sensor head A from that of sensor head B and outputs the value.
A Tr	Outputs the measurement value of a transparent object by using the sensor head A.
B Tr	Outputs the measurement value of a transparent object by using the sensor head B.
-A Tr	Outputs the measurement value of transparent object A with putting a negative sign.
-B Tr	Outputs the measurement value of transparent object B with putting a negative sign.
A1+B1[Tr]	Adds the measurement values of 1st surface of a transparent object measured by the sensor head A & B and outputs the value.
-(A1+B1)[Tr]	Adds the measurement values of 1st surface of a transparent object measured by the sensor head A & B and outputs the value with putting a negative sign.
A1-B1[Tr]	Subtracts the measurement value (1st surface of a transparent object) of the sensor head B from the measurement value (1st surface of a transparent object) of the sensor head A and outputs the value.
B1-A1[Tr]	Subtracts the measurement value (1st surface of a transparent object) of the sensor head A from the measurement value (1st surface of a transparent object) of the sensor head B and outputs the value.

❗ CHECK

- Before measuring a transparent object, set “A Tr”, “B Tr”, “-A Tr”, “-B Tr”, “A1+B1[Tr]”, “-(A1+B1)[Tr]”, “A1-B1[Tr]”, or “B1-A1[Tr]”. In this case, set the “Installation Mode” to the specular reflection. (Note that the mounting method of the sensor head is different between specular and diffuse reflection. Also, set the “Measurement Surface Reference” and “Transparent Object”. If not doing so, the measurement is executed up to the front surface of a transparent object from the sensor head. Set the recommended measurement mode for specular reflection.
- The settings of -A, -B, -(A+B), -A Tr, -B Tr, or -(A1+B1)[Tr] is reflected in all outputs such as the measurement value display and analog output.

• How to use

1 Display the “Output Selection” screen.

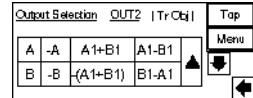
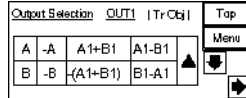
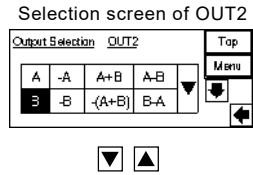
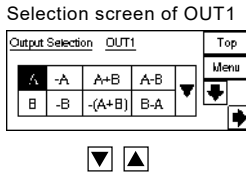

2 Touch the ▲▼ key (1) to change the list display.

The list display is changed each time the key is touched.

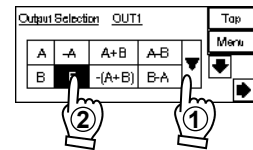

3 Touch your desired key (2) for performing “Output Selection”.

4

■ Transparent Object

This function selects a measurement surface from several surfaces in a transparent object.

According to the setting of “measurement surface reference”, select a measurement surface in a transparent object. Single or several surfaces can be selected from 1st to the maximum surface. (→Refer to the example of the next page.)

Supplemental remarks

- This function is valid when A Tr, B Tr, -A Tr, or -B Tr is selected at the “Output Selection”. (If one of the above is not selected, the setting screen of this function does not appear.)

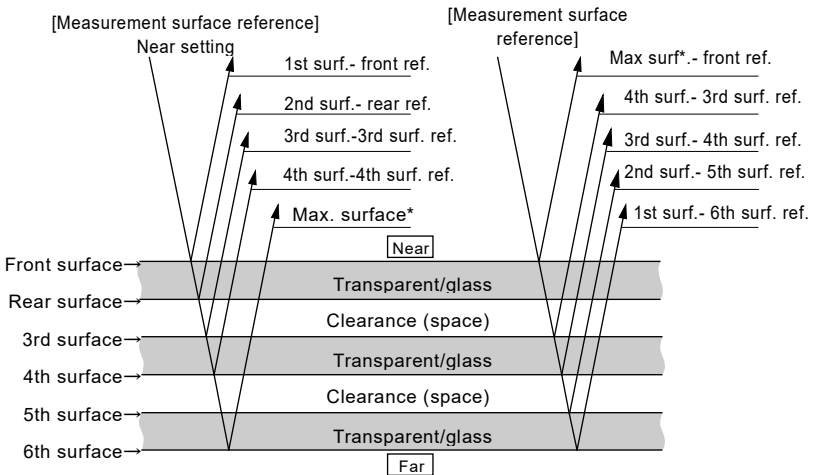

*Maximum seven surfaces can be detected.

CHECK

- Set the “Installation Mode” to the specular reflection. (Note that the mounting method of the sensor head is different between specular and diffuse reflection.)
- Before measuring a transparent object, make sure to set the recommended measurement mode for specular reflection.
- For selecting a measurement surface, confirm the setting of “Measurement Surface Reference”. The measurement surface is changed by setting the measurement surface reference. If the setting is wrong, the measurement cannot be performed accurately.

• How to use

1 Display the “Output Selection” screen.

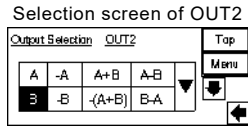
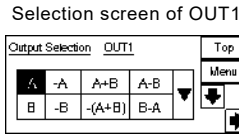

2 Touch the ▲▼ key to select your setting of “Output Selection”.

→ “Output Selection”

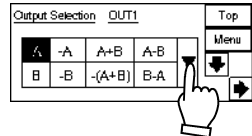

3 Touch the ⬆️⬆️ key to change the screen for selecting the measurement surface of “Transparent Object”.

*The setting of the transparent object can be performed only when “A”, “-A”, “B”, or “-B” of [Transparent Object] is selected at the “Output Selection”.

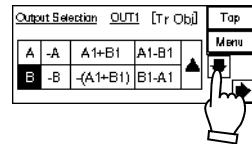

4 Touch the ▲▼ key to change the setting.

The setting is changed each time the key is touched.

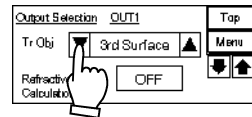

Ex When “Near setting” is set at the “Measurement Surface Reference”, select the measurement surface referring the below figure.

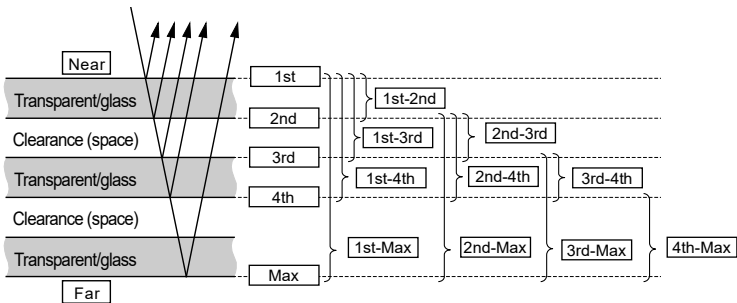

■ Refractive Index Calculation

This function reflects the setting refractive index to the measurement result.

When the “Refractive Index Calculation” function is set to “ON” for measuring a transparent object, the setting refractive index becomes effective and it is reflected in the measurement result. For measuring the thickness of a transparent object, set the function to “ON”, for measuring the clearance of a transparent object, set it to “OFF”. When the function is set to “OFF”, the setting refractive index is not reflected in the measurement result.

Supplemental remarks

The setting of the transparent object can be performed only when “A”, “-A”, “B”, or “-B” of [Transparent Object] is selected at the “Output Selection”.

CHECK

- Set the “Installation Mode” to the specular reflection. (Note that the mounting method of the sensor head is different between specular and diffuse reflection.)
- When a single surface (1st, 2nd, 3rd, 4th, Max surface) is selected, the function is invalid even if the function is set to “ON”.

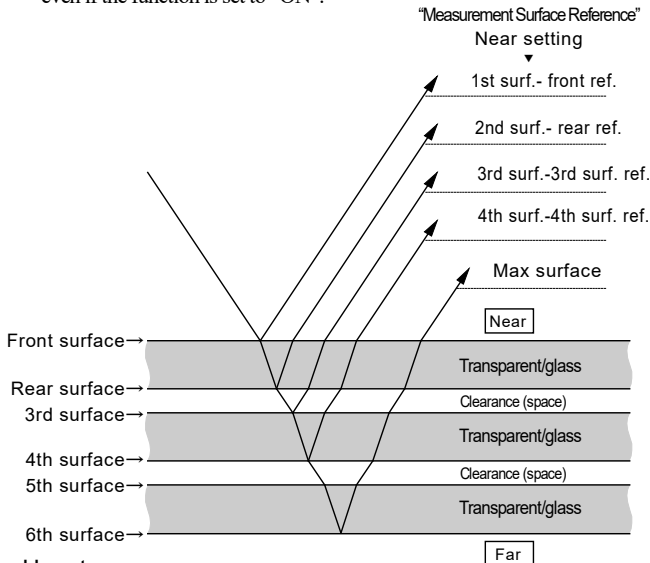

● How to use

- 1 Display the “Output Selection” screen.

Selection screen of OUT1

Output Selection				OUT1	Top
A	-A	A+B	A-B	▼	Menu
B	-B	-(A+B)	B-A	▼	Menu

Selection screen of OUT2

Output Selection				OUT2	Top
A	-A	A+B	A-B	▼	Menu
B	-B	-(A+B)	B-A	▼	Menu

- 2 Touch the $\blacktriangle\blacktriangledown$ key to change the setting and select the key of your choice.
 → ■ “Output Selection”

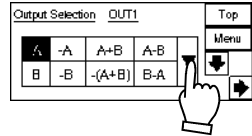

- 3 Touch the $\blacktriangle\blacktriangledown$ key to change the screen for selecting a measurement surface of “Transparent Object”.

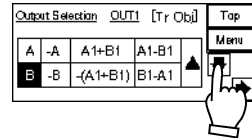

*The setting of the transparent object is valid only when “Transparent Object” is selected at the “Output Selection”.

- 4 Touch the $\blacktriangle\blacktriangledown$ key of “Tr Obj” and change the setting.
 The setting is changed each time the key is touched.

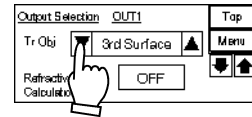

- 5 Touch the “Refractive Index Calculation” key to change the display to **ON**.

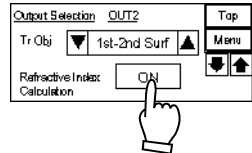

4

■ Refractive Index

This function is used for setting the refractive index of a transparent object to be measured.

Sets the refractive index of the measurement object. The setting range is 0.500000 to 2.000000. "1.000000" is set as a default.

Supplemental remarks

- This function is valid when "A Tr", "B Tr", "-A Tr", or "-B Tr" is selected at the "Output Selection" and "several surfaces" (1st-2nd, 1st-3rd, 1st-4th, 1st-Max", 2nd-3rd, 2nd-4th, 2nd-Max, 3rd-4th, 3rd-Max, 4th-Max) is selected at the "Transparent Object".
- The setting screen appears when "Refractive Index Calculation" is set to "ON".

❶ CHECK

Set the "Installation Mode" to the specular reflection. (Note that the mounting method of the sensor head is different between specular and diffuse reflection.)

● How to use

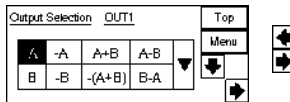

1 Display the "Output Selection" screen.

Selection screen of OUT1



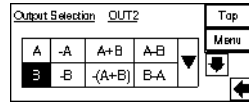

Selection screen of OUT2

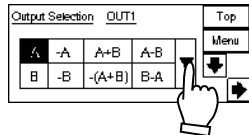

- 2 Touch the   key to change the setting and select the key of your choice.
→ ■ Output Selection



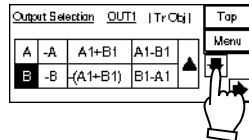

- 3 Touch the   key to change the screen for selecting a measurement surface of "Transparent Object".

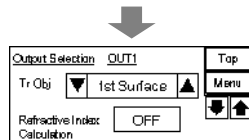

*The setting of the transparent object is valid only when "Transparent Object" is selected at the "Output Selection".



- 4 Changes the setting by touching   key of "Tr Obj".

The setting changes by touching the key.

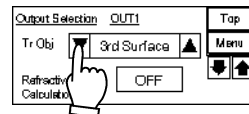

- 5 Touch the “Refractive Index Calculation” key to change the setting to **ON**.

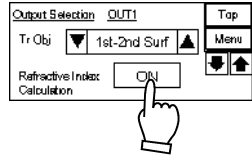

- 6 Touch the **↓** key to change the screen for setting “Refractive Index”.

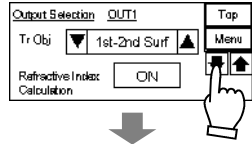

- 7 Touch **OUT1** (or **OUT2**) key to input the setting value.

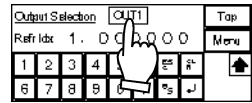

- 8 Set the refractive index by the numeric keys. The setting range is 0.500000 to 2.000000.

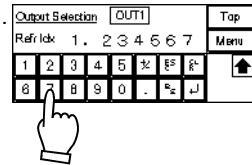

- 9 Touch the **↵** key to confirm the setting refractive index.

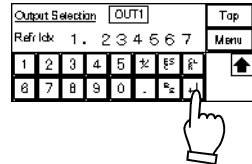

! CHECK

Note that it will take much time to set the “refractive index”.

■ Zero Set

This function is used for forcibly setting the measurement value to “0”.

Normally, the amount of displacement is displayed in reference to the center of measurement of the sensor head. However, after this function is set to “ON”, the amount of displacement is displayed in reference to the position when the function is set to “ON”.

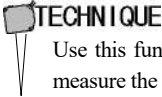

Use this function to reset the measurement value of a reference object to “0” and measure the displacement amount or make “Judgment Output”.

Supplemental remarks

- The zero set function can be set to “ON/OFF” by using the zero set terminals (ZS1, ZS2) of the external input terminal. →“2-1 Functions and Arrangement of I/O Terminal Block”
- The zero set terminals have both “zero set ON” and “zero set OFF” functions.
- When the zero set terminal is set to “ON” (short-circuited)*, the zero set function is set to “ON”. Keeping the zero set “ON” status for longer than 1 sec, then, 1 second later, the zero set is set to “OFF” status. (Thus, to set the zero set to “OFF”, set the zero set to “ON” at first.)
- When repeating the zero set “ON” input, the zero set function is also repeated.

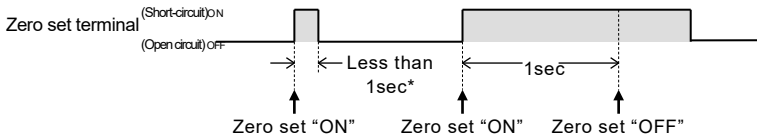

*More than the setting time of chattering prevention is necessary.

→“Chattering prevention of the terminal input”

CHECK

Note that the judgment output may be changed once because the zero set is set to “ON” immediately after the “zero set” is released by the external input terminal.

Ensure that the offset value remains after the zero set is released in case that the “Offset” is set to “ON”.

During an alarm occurrence, zero set cannot be set to ON.

● How to use

1 Display the “OUT1 (or OUT2) operation” screen.

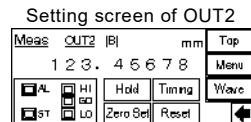
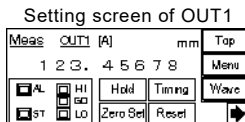

- 2 Touch the **Zero Set** key to set the measurement value to “0”.

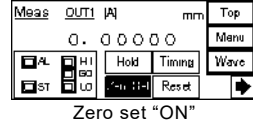
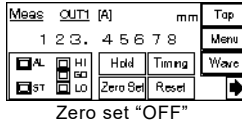
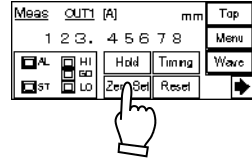

- 3 Touch the **Zero Set** key again to return to the measurement reference position to the center of measurement (default) by zero set function.

■ Timing

The measurement value can be on hold at the desired timing.

The measurement value is on hold by the timing terminal (TM1, TM2) of the external terminal input or by pressing the timing input button of compact programmable display. The judgment output is also on hold simultaneously. For the details, refer to → “Timing Chart”.

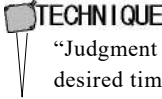

TECHNIQUE

“Judgment Output” is on hold by setting the timing input to “ON” at the desired timing. This enables loading of the judgment result at a later time.

Supplemental remarks

- Timing input cannot be controlled by the compact programmable display while it is set to “ON” by the external terminal input. The external terminal input has higher priority than the compact programmable display. Even when the timing input is set by both of them simultaneously, the setting of the external terminal input overrides the compact programmable display.
- While the timing input is set to “ON” by the external terminal input, the function cannot be set to “OFF” by pressing the timing input button of compact programmable display and the button display of compact programmable display is forcibly returned to “OFF”. Moreover, even when the function is set to “OFF” by the external terminal input while the timing input is set to “ON” by pressing the timing input button of compact programmable display, the button display of compact programmable display is forcibly returned to “OFF”.

4

① CHECK

The timing input status cannot be stored even by executing “Save” function.

● How to use

1 Display the “OUT1 (or OUT2) operation” screen.

Selection screen of OUT1

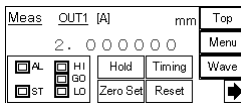

Selection screen of OUT2

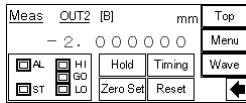

2 Touch the **Timing** key to hold the judgment output and measurement value.

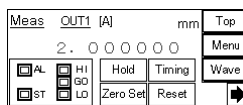
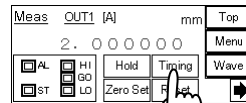

Timing input is released.

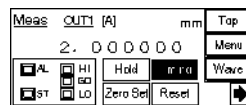

Timing input is executed.

3 Touch the **Timing** key again to release the timing input.

■ Reset

This function resets the measurement value.

The measurement value can be reset by touching the “Reset” button. When executing the “Peak measurement”, “Bottom measurement”, or “Peak to Peak measurement”, the measurement value that has been on hold can be reset at the desired timing.

The measurement value display of compact programmable display is turned to the data unfixed status by executing “Reset” function, and the fixed value(-999.999999), the setting fixed value for analog output (default: “-10.800[V]”), and the judgment output are all turned to “OFF”.

For the details, refer to → “Timing Chart”.



Supplemental remarks

The measurement value can be also reset by the reset terminal (RS1, RS2) of the external input terminal.

→ “2-1 Functions and Arrangement of I/O Terminal Block”



TECHNIQUE

When the reset input is set to “ON”, the “Judgment Output” is set to “OFF”. This function is effective to perform judgment for each measurement object at Peak, Bottom, and Peak to Peak measurements.

• How to use

1 Display the “OUT1 (or OUT2) operation” screen.

Selection screen of OUT1

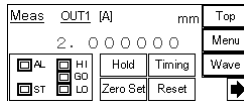

Selection screen of OUT2

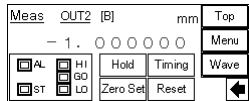

2 Touch the **Reset** key.

Touching the **Reset** key sets the temporary data unfixed status, and the display value of compact programmable display and analog output value are fixed.

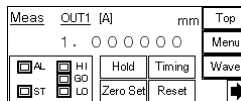
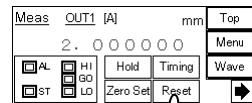

Reset is completed.

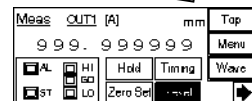

Reset in progress

* When the reset function is set to “ON”, the right screen appears temporarily, and immediately after that, the left screen appears and the setting is released. After the completion of reset, the measurement value is displayed after a fixed duration passed.

■ Hold

This function stops the updating of the measurement value display.

The updating of the measurement value display is stopped by touching the Hold button on the compact programmable display. This is a function only available for compact programmable display.



The instantaneous measurement value can be read at the compact programmable display by locking the updating of the measurement value display at the desired timing.

❗ CHECK

- This function does not hold the measurement display of the analog output, judgment output, alarm output, and Intelligent Monitor AiM.
- The hold function for the analog output, judgment output, and alarm output on the external terminal I/O shall be controlled by “Timing” function.
- The “Hold” status of compact programmable display is not stored even by executing “Save” function.

4

● How to use

1 Display the “OUT1 (or OUT2) operation” screen.

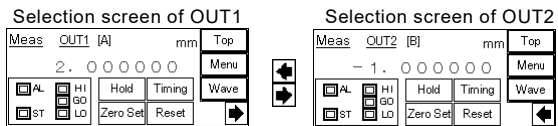

2 Touch the **Hold** key to hold the measurement value.

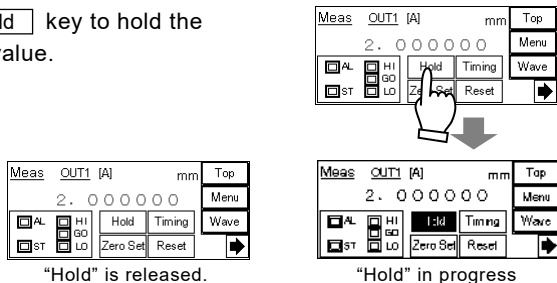

3 Touch the **Hold** key again to release the hold input.

■ Analysis Mode

This function performs the setting of the analysis mode.

The below shows the function of each analysis mode.

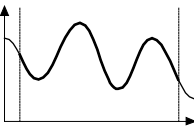
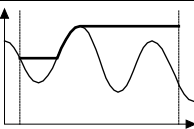
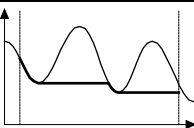
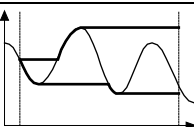
Setting item	Function	
Normal		Outputs the displacement in the center of measurement at a real time.
Peak		Holds and outputs the maximum value of the measurement value.
Bottom		Holds and outputs the minimum value of the measurement value.
Peak to Peak (P-P)		Holds and outputs the difference between the maximum and minimum values.

4

TECHNIQUE

Peak to Peak can be used for the vibration or eccentricity measurement.

● How to use

1 Display the “Analysis Mode” screen.

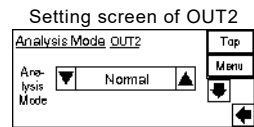
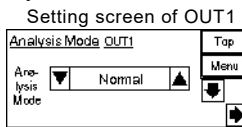

2 Touch the ▲▼ key to change the analysis mode.

The key display is changed in the below order each time the ▲ key is touched. Touching the ▼ key switches the analysis mode reversely.

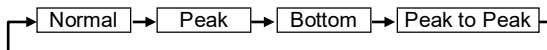
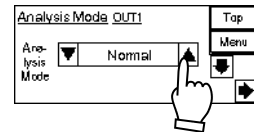

■ Filter Operation

This function cuts the unnecessary signal element to stabilize the measurement data.

The filter operation is selectable from the moving average, low-pass filter, and high-pass filter. The filter picks out the measurement data for required amount of frequency, cuts the unnecessary signal element, then, acquires the stabilized measurement value.

● Filter setting

■ Moving average

Performs moving average on the measurement result for the setting average times.

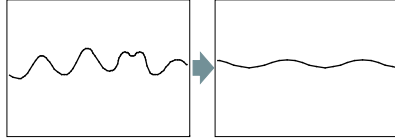

■ Low-pass filter

Select Low-pass filter when you want to pick out only the signal with low frequency from the measurement data. The signal elements lower than the setting cutoff frequency are picked out.

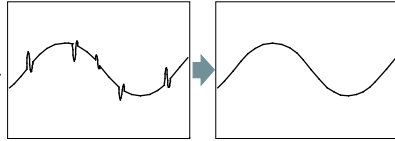

TECHNIQUE

Low-pass filter is able to measure the stabilized displacement by minimizing noise that might occur depending on the metal surface condition.

■ High-pass filter

Select High-pass filter when you want to pick out only the signal with high frequency from the measurement data. The signal elements higher than the setting cutoff frequency are picked out.

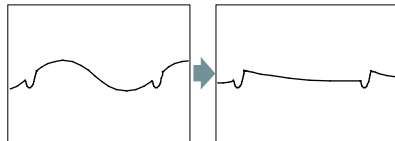

TECHNIQUE

High-pass filter is effective for detecting a joint line or slot of objects such as the eccentricity of a revolving object under a state of largely vibration or inclination since the influence of gradual change is minimized.

● Average Times

Sets the average times for performing the moving average. This is used for stabilizing the unstable (including variation) measurement value. This becomes valid when "Moving Average" is selected.

● Cutoff Frequency

Sets the cutoff frequency for Low-pass filter and High-pass filter. This becomes valid when "Low-pass Filter" or "High-pass Filter" is selected. For stability of filter effectiveness, set the value to below than 1/2 of the "Sampling Cycle" setting value. For setting of the "Sampling Cycle", refer to → "4-3-3 Common Setting" - "Sampling Cycle".

❗ CHECK

- Make sure to perform the actual measurement and confirm the results before setting the cutoff frequency because of the different conditions.

• How to use

1 Display the “Filter Operation” screen.

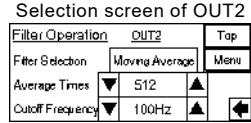
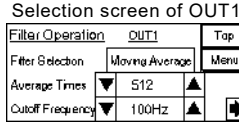

2 Touch the “Filter Selection” key to select the desired filter.

The display changes as below by touching the key.

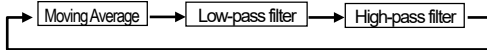
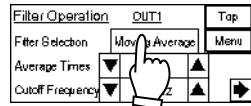

Setting of the average times:

3 Touch the ▲▼ key of “Average Times” to select the desired average times.

The display changes as below by touching the ▲ key. Touching the ▼ key changes in a counterclockwise direction.

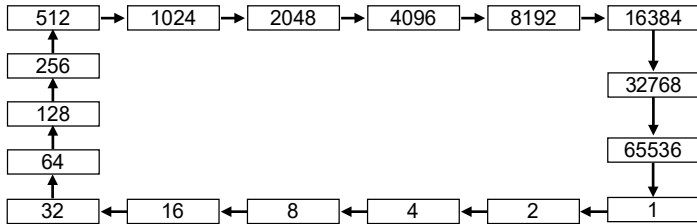
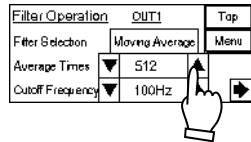

Setting of Low-pass/High-pass filter:

3 Touch the ▲▼ key of “Cutoff Frequency” to select the desired cutoff frequency.

The display changes as below by touching the ▲ key. Touching the ▼ key changes in a counterclockwise direction.

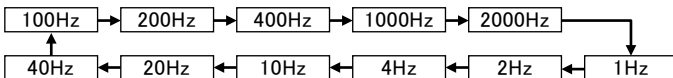
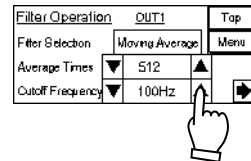

■ Operation Coefficient

This function is used for multiplying the measurement value by the operation coefficient and outputting the data.

Final measurement value = Operation coefficient x Measurement value + Offset value

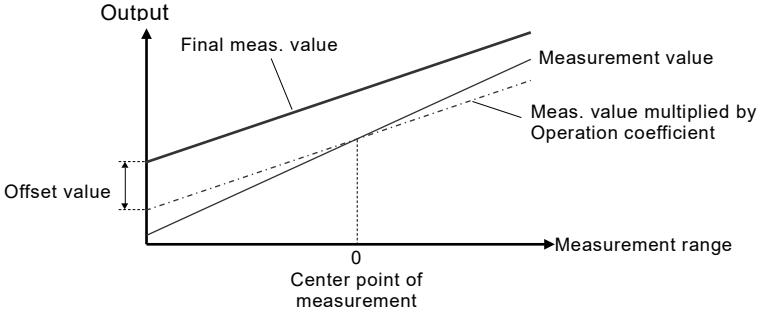

- How to use

1 Display “Ope. Coef.” Screen.

Selection screen of OUT1

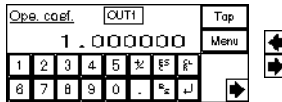

Selection screen of OUT2

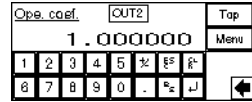

2 Set the operation coefficient.

- (1) Touch the **OUT1** (**OUT2**) key to make the numerical value input possible.
- (2) Input the numerical value.
- (3) Touch the **↵** key to confirm the value.

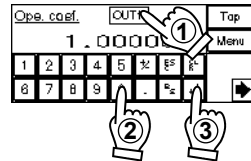

■ Offset

The desired setting value can be added to/subtracted from the measurement value.

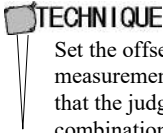

Set the offset value by measuring the size of a master (reference) measurement object. When measuring an object, set the Zero Set “ON” so that the judgment of the size tolerance can be performed easily because of the combination of the zero set and judgment output functions.

❗ CHECK

- Set “Offset” and set “Zero Set” to “ON” to make the setting value offset value.
- The display limit of the measurement value is ± 950.000000 mm. Be sure to set the offset value within the range.

• How to use

- 1 Display the “Offset” screen.

Selection screen of OUT1

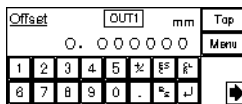

Selection screen of OUT2

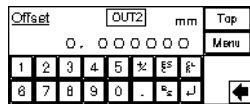

- 2 Touch the **OUT1** (or **OUT2**) key to prepare for inputting the setting value.

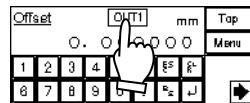

- 3 Set the setting value by the numeric keys.
The input range is -950.000000 to $+950.000000$ [mm].

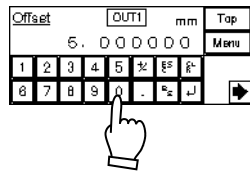

- 4 Touch the **↵** key to confirm the offset value.

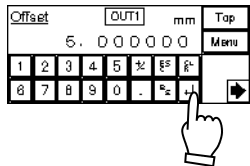

■ Upper/Lower Limit Value of Judgment Output

This function sets the upper and lower limit values for judgment of the measurement value.

The output status changes in three types as the below:

measurement value > upper limit value: HI Output

lower limit value \leq measurement value \leq Upper limit value: GO Output

measurement value < lower limit value : LO Output

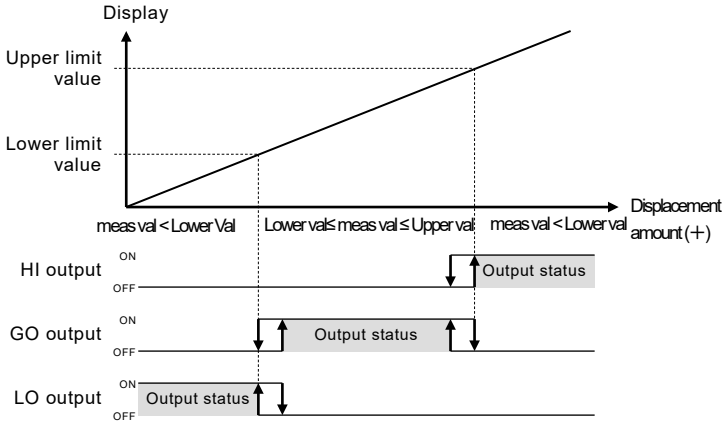

Supplemental remarks

- The input range of both upper/lower limit values is -950.000000 to +950.000000[mm].
- The initial value of the upper limit value is the positive upper limit of the measurement range.
The initial value of the lower limit value is the negative lower limit of the measurement range.

CHECK

Make sure that the upper limit value is higher than the lower limit value.

- How to use



1 Display the “Up Lmt Val” screen.

Selection screen of OUT1



Up Lmt Val	OUT1	mm	Top
5.	□ □ □ □ □ □		Menu
1	2	3	4
5	%	⊞	⊞
8	7	8	9
0	.	%	⊞

Selection screen of OUT2

Up Lmt Val	OUT2	mm	Top
5.	□ □ □ □ □ □		Menu
1	2	3	4
5	%	⊞	⊞
8	7	8	9
0	.	%	⊞

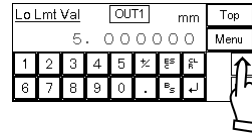
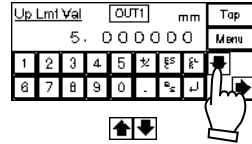
- 2 Touch the   keys to change the screen between “Up Lmt Val” and “Lo Lmt Val”.



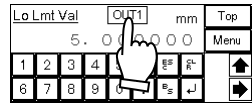

- 3 Touch the  (or ) key to prepare for inputting the setting value.

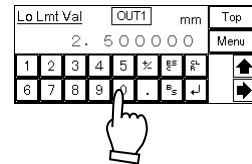

- 4 Set the setting value by touching the numeric keys.

The input range is -950.000000 to +950.000000[mm].



- 5 Touch the  key to confirm the offset value.

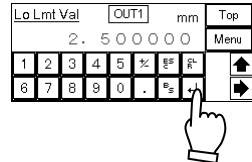

■ Upper/Lower Hysteresis of Judgment Output

This function stabilizes the judgment output against the chattering of the measurement value.

The below example graphically shows the correlation between the hysteresis value and ON/OFF of the output. The function acts on the upper/lower limit values when the output is in “ON” status.

Ex In case of GO output

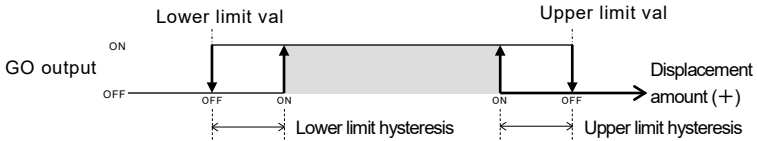

TECHNIQUE

In case that the measurement value fluctuates around the upper/lower limit value of the judgment output, the output repeats “ON/OFF” status. This may cause the unstable judgment output.

In this case, set the upper/lower limit hysteresis to prevent such chattering.

Supplemental remarks

The input range of both upper/lower limit hysteresis values is +000.000000 to +950.000000 [mm].

CHECK

After setting the operating condition, make sure to check a rough deviation of the measurement value at P-P before setting the hysteresis value because the deviation differs depending on measurement object and setting of “Average Times”.

Set the upper/lower limit hysteresis smaller than the upper/lower limit value of judgment output.

• How to use

1 Display the “Up Lmt Hys” screen.

Selection screen of OUT1

Up Lmt Hys	OUT1	mm	Top
0.	0 1 0 0 0 0		Menu
1	2	3	4
5	%	←	→
6	7	8	9
0	.	↵	↵

Selection screen of OUT2

Up Lmt Hys	OUT2	mm	Top
0.	0 1 0 0 0 0		Menu
1	2	3	4
5	%	←	→
6	7	8	9
0	.	↵	↵

2 Touch the keys to change the screen between “Up Lmt Hys” and “Lo Lmt Hys”.

Up Lmt Hys	OUT1	mm	Top
0.	0 1 0 0 0 0		Menu
1	2	3	4
5	%	←	→
6	7	8	9
0	.	↵	↵

3 Touch the **OUT1** (or **OUT2**) key to prepare for inputting the setting value.

Up Lmt Hys	OUT1	mm	Top
0.	0 1 0 0 0 0		Menu
1	2	3	4
5	%	←	→
6	7	8	9
0	.	↵	↵

- 4** Set the setting value by touching the numeric keys.

The input range is +000.000000 to +950.000000[mm].

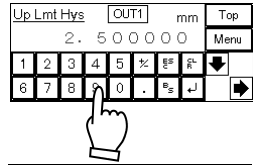

- 5** Touch the  key to confirm the offset value.

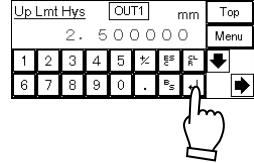

■ Analog Scaling

This function executes scaling of the analog voltage output to a desired value.

The system performs scaling of the analog voltage output to the desired value within $\pm 10V$.

Fix two points of the desired voltages to “a” and “b” for each A and B of the current voltage. Input the current measurement value as the value “A”, and input the desired voltage as the value “a”. Also, set the value “B2” and “b” in the same manner. Then, the analog voltage output can be scaled easily.

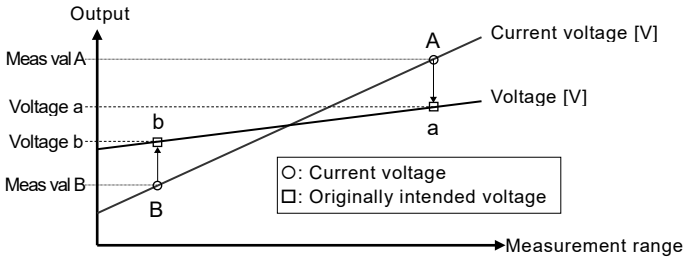

Supplemental remarks

- The input range of both measurement value A and B is -950.000000 to $+950.000000$ [mm], and that of both voltage a and b is -10.000 to $+10.000$ [V].
- The initial value of the measurement A is positive upper limit value of the measurement range and that of the measurement B is negative lower limit value of the measurement range, that of the voltage a is $+5.000$ [V], and that of the voltage b is -5.000 [V].
- The display limit of the measurement value is ± 950.000000 mm. Make sure that the setting value does not exceed the display limit.

CHECK

- The analog current output interlocks the setting of the analog voltage output. (The voltage and current cannot be set individually.) The default is set to 4mA at -5.000 [V], 20mA at $+5.000$ [V]. →“8-6 Characteristics” “Output Characteristics and Measurement range Indicator”
- Check the input range of your input device such as AD board before setting.

● How to use

1 Display the “Analog Scaling” screen.

Selection screen of OUT1

Analog Scaling		OUT1	Top
Meas A	[mm]	Volt a [v]	Menu
5,000000	=	5,000	Change
Meas B	[mm]	Volt b [v]	
-5,000000	=	-5,000	

Selection screen of OUT2

Analog Scaling		OUT2	Top
Meas A	[mm]	Volt a [v]	Menu
5,000000	=	5,000	Change
Meas B	[mm]	Volt b [v]	
-5,000000	=	-5,000	

2 Touch the **Change** key.

The screen is changed.

Analog Scaling		OUT1	Top
Meas A	[mm]	Volt a [v]	Menu
5,000000	=	5,000	Change
Meas B	[mm]	Volt b [v]	
-5,000000	=	-5,000	



3 Change the screen by each key.

Key	Screen
Meas A	---Measurement value A input screen
Volt a	---Voltage value a input screen
Meas B	---Measurement value B input screen
Volt b	---Voltage value b input screen
Load (top)	---Measurement value A load screen
Load (bottom)	Measurement value B load screen

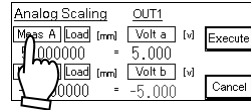

- For inputting the measurement value or voltage value
- For loading the measurement value from the current value

4 Set/change the measurement value or voltage value.

For input method of the measurement value and voltage value, refer to →“For inputting the measurement value or voltage value”, and For loading method of the measurement value, refer to →“For loading the measurement value from the current value”.

5 Touch the **Execute** key.

Touch the **Cancel** key to cancel inputting.

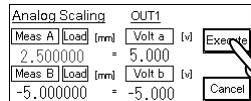

Execution of the analog scaling function starts with the setting value.

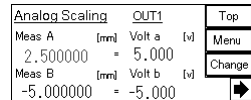

In case that the setting value is invalid, the right screen appears. Touch the **OK** key and confirm the setting value, then, execute again.

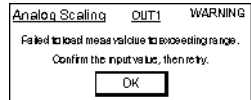

After the completion of setting, the screen of step 1 appears again.

For inputting the measurement value and voltage

1 Touch the key you want inputting the value.

Touch the **Meas A**, **Meas B**, **Volt a**, or **Volt b** key. The screen changes.

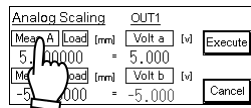

2 Touch the **OUT1** (or **OUT2**) key to prepare for inputting the setting value.

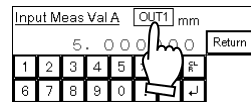

3 Input the value (1), and touch the **↵** key to confirm the value.

For returning the above step 5, touch the

Return key.

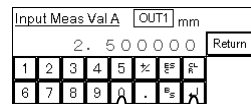

For loading the measurement value from the current value

- 1 Touch the key you want to load the value.

Touch the **Load** key of the measurement value A or B. The screen is changed.

Analog Scaling		OUT1		
Meas A	Load	[mm]	[Volt a]	[v]
5.0000		=	5.000	
Meas B		[ml]	[Volt b]	[v]
-5.0000		=	-5.000	
				Execute
				Cancel



Load Meas Val A		OUT1		
Upper:Meas Val A/Lower:Curr Vol				
5.	0	0	0	0
2.	5	0	0	0
Load Meas Val A from Curr val				
Return				

- 2 Touch the **Load Meas Val A from Curr val.** key.

The current value is input at the up side of the measurement value.

Load Meas Val A		OUT1		
Upper:Meas Val A/Lower:Curr Vol				
2.	5	0	0	0
2.	5	0	0	0
Load Meas Val A from Curr val				
Return				

For returning the above step 5, touch the **Return** key.

■ Analog Output at Alarm

This function sets the analog output status when an alarm is issued.

It can select whether holding the previous value or setting a fixed value for the analog output under an alarm operation status (poor light intensity, or measurement disabled when a target object goes off the measurement range).

Supplemental remarks

- The input range of fixed value is -10.800 to +10.800[V], and the initial value is +10.800[V].
- The current output varies on load impedance. The maximum value is 25.0[mA].

CHECK

- Check the input range of AD board before setting.
- Before setting of analog output at alarm, read →“4-4-1 Alarm Setting and Outputs” carefully.

● How to use

- 1 Display the “Analog Output at Alarm” screen.

Selection screen of OUT1

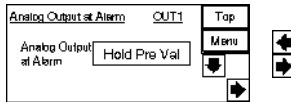

Selection screen of OUT2

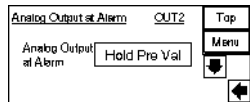

- 2 Touch the “Analog Output at Alarm” key.

The display is changed between

and each

time the key is touched.

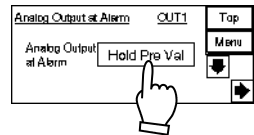

When selecting “Fixed Value”

- 3 Touch the  key.

The screen for inputting the fixed value appears.

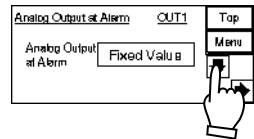

- 4 Input the fixed value.

- (1) Touch the (or) key to prepare for inputting the setting value.

- (2) Input the value.

- (3) Touch the  key to confirm the value.

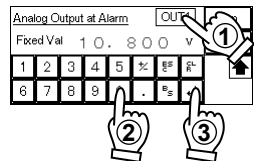

■ Analog Output at Data Unfixed

This function sets the analog output when the data is unfixed.

“-999.999999” is displayed for the measurement value of the digital output at data unfixed and AiM.

① CHECK

- The output range is -10.800 to +10.800[V], and the initial value is -10.800[V].
- The analog current output interlocks this setting.
- The current output varies with load impedance. The maximum value is 25.0[mA].
- Setting of the voltage and current cannot be performed individually.
- Check the input range of AD board before setting.
- Before setting of analog output at data unfixed, carefully read →“4-4-2 Conditions When Output Data becomes Unfixed.”.

• How to use

1 Display the “Analog O/P at Data Unfixed” screen.

Selection screen of OUT1

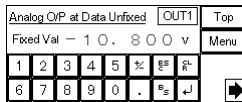

Selection screen of OUT2

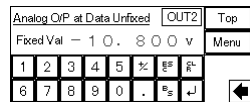

2 Input the fixed value.

- (1) Touch the **OUT1** (or **OUT2**) key to prepare for inputting the setting value.
- (2) Input the value.
- (3) Touch the **↵** key to confirm the value.

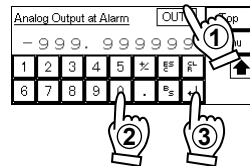

■ Digital Output at Alarm

This function sets the digital output status when an alarm is issued.

It can select whether holding the previous value or setting a fixed value for the digital output (measurement value display of compact programmable display and the judgment output Intelligent Monitor AiM) under an alarm operation status (poor light intensity, or measurement disabled when the target object goes off the measurement range). When selecting the fixed value, the digital data is displayed “+999.999999”. When selecting the “Hold the Previous Value”, the hold value is displayed.

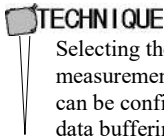

TECHNIQUE

Selecting the fixed value can detect an alarm issued status easily from the measurement result. Especially this function is effective in that an alarm status can be confirmed when the measurement value is loaded by performing the data buffering function.



Supplemental remarks

“Hold Previous value” is set as a default.

❗ CHECK

- In case of selecting the fixed value, the judgment output is on hold at “HI” by interlocking with the digital output when an alarm is issued.
- For setting of the digital output at alarm, read →“4-4-1 Alarm Setting and Outputs” carefully.

● How to use

1 Display the “Digital Output at Alarm” screen.

Selection screen of OUT1

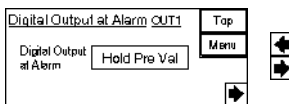

Selection screen of OUT2

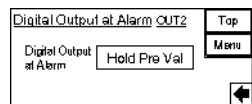

2 Change the setting of the digital output status when an alarm is issued.

Touch the “Digital Output at Alarm” key.

The display is changed between

and each

time the key is touched.

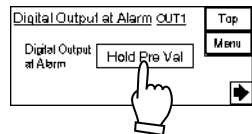

■ Alarm Output Delay

This function delays the output from the alarm terminal.

It can select whether outputting at a real time or holding the previous normal value up to the setting number of times under an alarm operation status (poor light intensity, or measurement disabled due to deviation from the range).

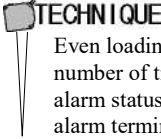

TECHNIQUE
Even loading the measurement value ignoring the alarm status for the setting number of times (set at “Alarm Delay”) since you do not want to reflect the alarm status to the measurement value, the alarm occurrence status from the alarm terminal can be checked by setting “Alarm Output Delay” to “OFF”.

❗ CHECK

- When this setting is “OFF”, in regardless with the setting of number of alarm delay times, the alarm status is output to the alarm output terminal at a real time.
- For setting of “Alarm Output Delay”, read → “4-4-1 Alarm Setting and Outputs” carefully.

• How to use

1 Display the “Alarm Output Delay” screen.

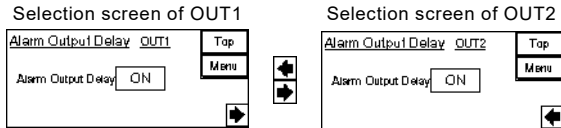

2 Change the setting of the output delay at alarm.

The display is changed between ON and OFF each time the key is touched.

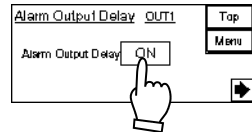

■ Digit Number of Measurement Value

This function sets the display digit number of the measurement value.

It can set the display of the number of decimal places on compact programmable display. The display of the number of decimal places can be selected among six settings: 6digits/5digits/4digits/3digits/2digits/1digit. When omitting the number of decimal places, round off the value.

❗ CHECK

- “Digit Number of Measurement Value” can be set at “OUT1”, “OUT2”, and “Measurement Value” menu screens. The same performance is done in either setting.
- The measurement value display of AiM interlocks with this setting.

● How to use

Setting at “OUT1” or “OUT2” menu

1 Display the “Digit No of Meas Val” screen.

Setting screen of OUT1

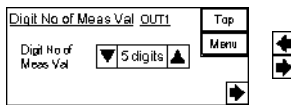

Setting screen of OUT2

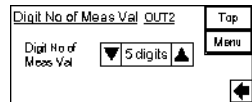

2 Touch the ▲▼ key of “Digit No of Meas Val” to change the setting.

The number of digits display is changed as below by touching the ▼ key. Also, it is changed in counterclockwise by touching the ▲ key.

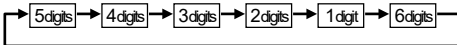
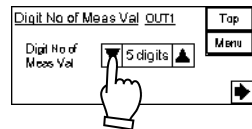

Setting at “Measurement Value” menu

1 Display the “Digit No of Meas Val” screen.

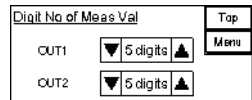

2 Touch the ▲▼ key of “Digit No of Meas Val” to change the setting.

The number of digits display is changed as below by touching the ▼ key. Also, it is changed in counterclockwise by touching the ▲ key.

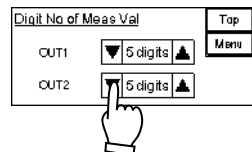

4-3-3 Common Setting

■ Sampling Period

This function sets the sampling cycle of measurement.

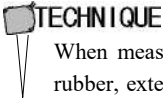

TECHNIQUE
When measuring an object with poor received light intensity such as black rubber, extend the sampling cycle to get sufficient light for performing stable measurement.

Cycle [μ s]	Frequency	Measurement range	Meas. object
10 μ s	100KHz	Differs depending on product type	
20 μ s	50KHz		
40 μ s	25KHz	All in the measurement range	
100 μ s	10KHz		
200 μ s	5KHz		
400 μ s	2.5KHz		
1ms	1KHz		
2ms	500Hz		

*The measurement range may become narrow depending on measurement object type.

❗ CHECK

- When the sampling cycle is set to 10 μ s or 20 μ s, the measurement range is limited.
- When the sampling cycle is set to 10 μ s or 20 μ s, the functions of median filter are limited.

As for the functions of median filter, refer to “4-3-1 Head Setting” – ‘Median Filter’.

Ex In case of HL-C203B



In case of setting the installation mode to “diffuse reflection”, the measurement range is 3.8 to 5.0[mm] for the sampling cycle 10 μ s, 0 to 5.0[mm] for the 20 μ s, or \pm 5mm for the other cycles. For the setting range for each product type, refer to “8-2 Sensor Head Specifications”.



- If the sampling cycle is changed, the data unfixed status occurs because the sampling sequence is executed again. When the data becomes unfixed, the strobe output is set to “OFF”, and after the data become fixed, the strobe output is set to “ON” and the measurement data display starts.
- The resolution of the received light intensity waveform is also limited.

- How to use

- 1 Display the “Sampling Cycle” screen.



- 2 Touch the   keys of Sampling Cycle to change the setting.

The sampling cycle display is changed as below by touching the  key. Also, it is changed in counterclockwise by touching the  key.

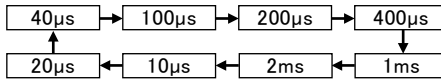
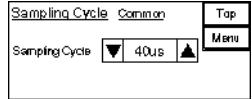

■ Terminal Input Control

Using this function, two outputs (OUT1 & OUT2) can be controlled by one input operation.

Two outputs (OUT1 & OUT2) can be operated by inputting only OUT1 (the timing input, zero set input, and reset input).



TECHNIQUE

Select “All” to control the two sensor heads at the same timing, e.g. when checking the inclination of a measurement object. This can minimize the deviation caused by control signals input from terminal.

❗CHECK

When “All” is set, the operation can be performed only from OUT1. Note that OUT2 becomes invalid in this case.

● How to use

1 Display the “Terminal Input Control” screen.

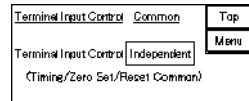

2 Touch the “Terminal Input Control” key to change the setting **Independent** or **All**. The setting display is changed between **Independent** and **All** each time the key is touched.

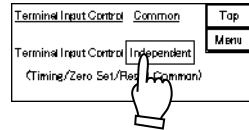

■ Chattering Prevention of Terminal Input

This function can prevent the chattering of the terminal input.

This function is used to prevent chattering for terminal input using the relay contact or switch contact. The below list shows three settings of the function.

Setting	Function
OFF	Continuous input of longer than 50μs
ON1	Continuous input of longer than 20ms
ON2	Continuous input of longer than 100ms

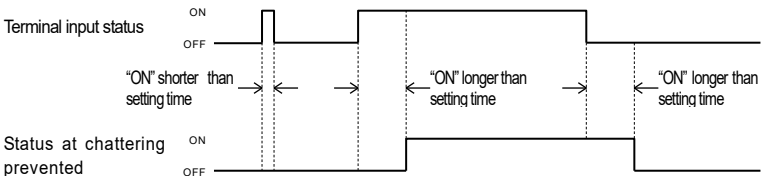

When acted in level, the chattering prevention functions while input is OFF.

❗ CHECK

Only “ON2” is used for the laser emission stop input, remote interlock input, and memory change input to prevent misoperation.

• How to use

- 1 Display the “Chattering Prev for Term I/P” screen.

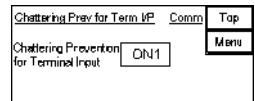

- 2 Touch the “Chattering Prevention for Terminal Input” key to select the setting. The display is changed as below each time the key is touched.

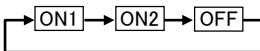
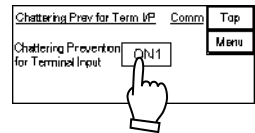

■ Judgment Output Off Delay

This function is used for delaying the timing of switching OFF from ON of judgment output.

TECHNIQUE

This function is effective for loading quickly fluctuated output into a sequencer, etc.

Setting	Function
OFF	Output corresponding with a sampling cycle
2ms	Off delay for 2ms
10ms	Off delay for 10ms
100ms	Off delay for 100ms
Hold	Hold when once turned ON. Reset input to release it.

Timing of judgment output:

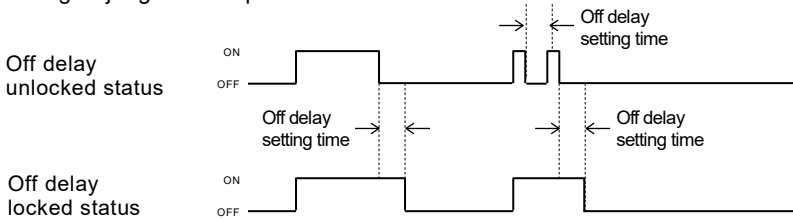

❗ CHECK

- When the actual terminal output operation is faster than the off delay setting time, the off delay time becomes effective from the last turning OFF point.

• How to use

1 Display the “Judg. O/P OFF Delay” screen.

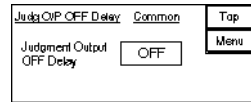

2 Touch the “Judgment Output OFF Delay” key to select the setting.

The display is changed as below each time the key is touched.

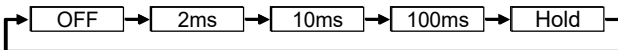
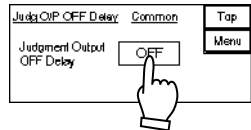

■ Interference Prevention

This function is used for preventing interference between 2 sensor heads.

Set this function when beam from the other sensor head enters into the mutual interference area.

→ “8-6 Characteristics” – “Mutual Interference Area”

TECHNIQUE

When connecting two sensor heads, there is the case that one sensor head receives beam from the other sensor head, and this might cause a measurement error if the setting distance between the two sensor heads is close. In this case, by setting the Interference Prevention function to ON, two sensor heads emit beam in turn and are not susceptible to the interference of the other sensor head. The data update increases twice of the setting sampling cycle.

4

❗ CHECK

In case of connecting one sensor head, sampling cycle doubles when this function is set to ON. Make sure to set this function to OFF when one sensor head is connected.

• How to use

1 Display “Interference Prevention” screen.

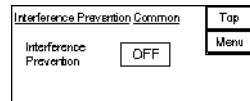

2 Switch the setting of interference prevention.

The display is switched ON and OFF each time the “Interference Prevention” key is touched.

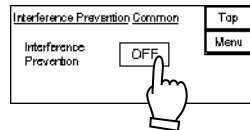

4-3-4 System Setting

■ Display Update Cycle of Measurement Value

This function sets the display update cycle of the measurement value on the compact programmable display.

Set the display update cycle to slower (longer) as possible because fast (short) display update cycle causes the measurement value display hard-to-read due to quickly change in the measurement value.

Setting	Function
Fast	Updates at each sampling cycle.*
Standard	Updates at each approx. 0.3ms.
Slow	Updates at each approx. 500ms.
Very slow	Updates at each approx. 1000ms.

*Note that the limitation of programmable display speed is applied to this cycle.

This setting is applied to the measurement value display of compact programmable display, alarm output, strobe output, and judgment output.

Terminal outputs (analog output, alarm output, strobe output, judgment output) are updated at every sampling cycle.

❗ CHECK

“Display Update Cycle of Measurement Value” can be set at either of “System” menu or “Measurement Value” menu. Setting at either of them is reflected in another menu setting.

● How to use

Setting at “System” menu

1 Display “Update Cycle of Meas Val” screen.

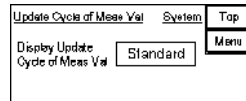

2 Touch the “Update Cycle of Meas Val” key to select the setting.

The display is changed as below each time the key is touched.

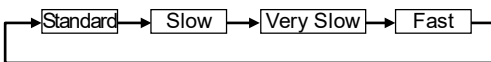
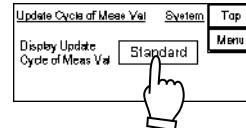

Setting at “Measurement Value” menu

1 Display “Update Cycle of Meas Val” screen.

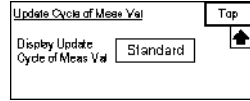

2 Touch the “Update Cycle of Meas Val” key to select the setting.

The display is changed as below each time the key is touched.

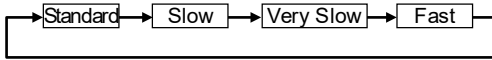
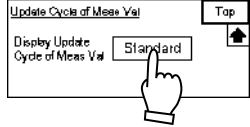

3 Touch  key to return to the “Measurement Value Display” screen.

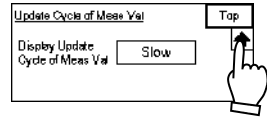

■ Change Indication Unit

This function is used for changing the indication unit of the measurement value on compact programmable display.

The indication unit of the measurement value is selectable from mm unit and μm unit.

❗ CHECK

- This function is invalid for the setting value indication. The setting value is always indicated in mm unit.
- When selecting μm unit, the setting of “Digit Number of Measurement Value” becomes invalid.

• How to use

- 1 Display “Change Indi. Unit” screen.

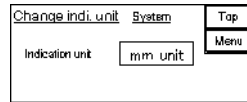

- 2 Switch the setting of Indication Unit.

The display is switched **mm Unit** and **μm Unit** each time the “Indication Unit” key is touched.

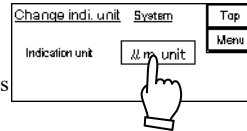

■ Output Setting Copy

“OUT Setting” contents can be copied between OUT1 and OUT2.

The setting contents related to the memory output that is specified at “Memory Change” function can be copied between OUT1 and OUT2 (OUT1→OUT2, OUT2→OUT1).

❗ CHECK

This function cannot copy the timing, reset, and hold outputs.

● How to use

- 1 Display the “Copy O/P Setting” screen.

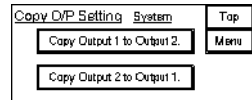

- 2 Touch the **Copy Output 1 to Output 2** key or **Copy Output 2 to Output 1** key.

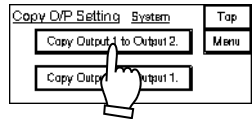

- 3 The confirmation screen appears.

Touch the **Yes** key to copy, or touch the **No** to display the Step 1 screen.

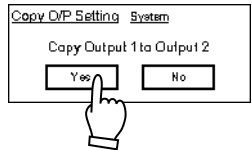

- 4 The screen of notifying the completion of copy appears.

Touch the **OK** key to return to the “System Menu 1/2”.

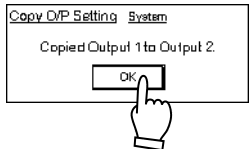

■ Priority Setting of Memory Change

This function sets priorities among command or terminal memory changes.

In case that the command is received a higher priority for memory change, memory change by the terminal is ignored (set the priority to “Terminal” before performing memory change from the terminal).

In case that the terminal is received a higher priority for memory change, the memory change by command is ignored (set the priority to “Command” before performing memory change by command).

● How to use

1 Display the “Priority of Mem Chg” screen.

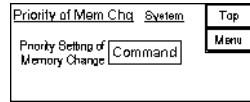

2 Touch the “Priority Setting of Memory Change” key to change the setting between and .

The display is changed between and each time the key is touched.

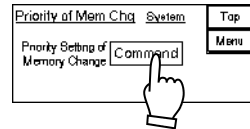

■ Memory Change

This function specifies the destination (memory) for storing the setting contents.

When starting up the system with the specified memory No. (other than the default setting), set the priority to command or terminal as below.

“Priority Setting of Memory Change”	Function operation at start-up
Command priority	Starts-up the system with the last specified memory No. at the memory change function.
Terminal priority	Starts-up the system with the memory No. that is input by terminal.

❗ CHECK

- Even the memory change is set in the system operation, the setting cannot be reflected (memory change is not executed) until memory change is executed in the next start-up.
- When the memory change is executed, the data unfixed status may occur temporarily. At data unfixed status, the strobe output is set to “OFF”, and after the data become fixed, the strobe output is set to “ON” and the measurement data display starts.
- Note that the setting contents are deleted at the next start-up if the memory change setting is not saved.

● How to use

1 Display the “Memory Change” screen.

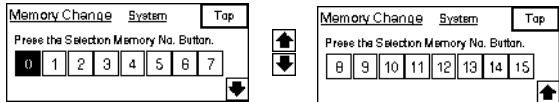

2 Press the selection memory No. button.

The default is set to No.0.

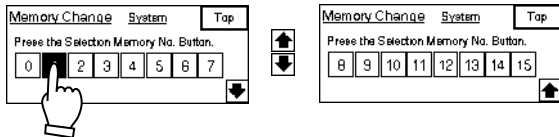

■ Memory Copy

The stored contents in the memory can be copied to the other memories.

If the destination and source memory is the same, the data in the memory is just overwritten.

❶ CHECK

· Note that the copied setting contents are deleted at the next start-up if the copied setting content are not saved.

• How to use

1 Display the “Memory Copy” screen.

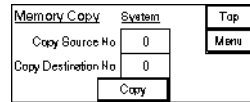

2 Select the copy source No. (0 to 15).

Touch the **Copy Source Memory No.** key to change the copy source No. in the order of 0 to 15.

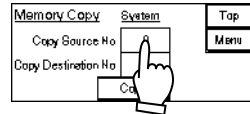

3 Select the copy destination No. (0 to 15).

Touch the **Copy Destination Memory No.** key to change the copy destination No. in the order of 0 to 15.

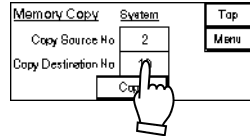

4 Touch the **Copy** key.

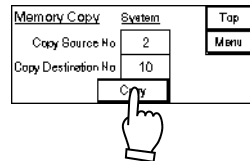

5 The confirmation screen appears.

Touch the **Yes** key to copy, or touch the **No** to display the Step 1 screen.

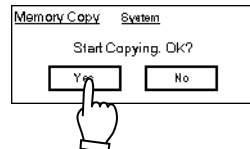

6 The screen of notifying the completion of copy appears.

Touch the **OK** key to return to the “System Menu 1/2”.

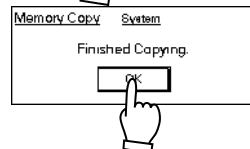

■ Initialization

This function deletes all setting contents in the memory and initializes the settings again.

If the initialization is not saved, the system operates with the previous settings at the next start-up.

Setting	Function
Initialize	Initializes the settings other than the common memory settings.
Initialize All Memory	Initializes the all settings including the common memory settings.

! CHECK

Note that the initialized setting contents are deleted at the next start-up if the initialized setting contents are not saved.

Refer to →“Save”.

When the initialization is executed, the data unfixed status may occur temporarily. At data unfixed state, the strobe output is set to “OFF”, and after the data become fixed, the strobe output is set to “ON” and the measurement data display is started.

● How to use

In case of initializing the memory setting in current use

- 1 Display the “Initialize” screen.

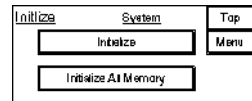

- 2 Touch the key.
The confirmation message appears.

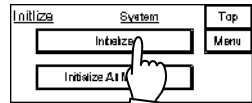

- 3 Touch the key.
The message of notifying the completion of initialization appears.
*Touch the key to cancel the initialization and return to step 1.

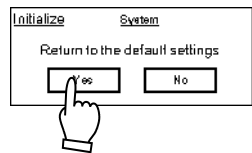

- 4 Touch the key.
Touch the key to return to the “System Menu 1/2”.

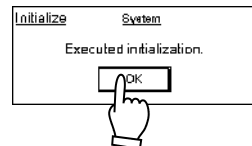

In case of initializing the settings of all memories

1 Display the “Initialize” screen.

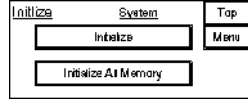

2 Touch the **Initialize All Memory** key.

The confirmation message appears.

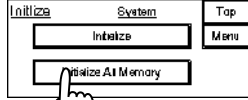

3 Touch the **Yes** key.

The message of notifying the completion of initialization appears.

*Touch the **No** key to cancel the initialization and return to step 1.

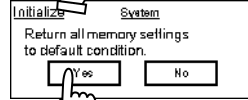

4 Touch the **OK** key.

Touch the **OK** key to return to the “System Menu 1/2”.

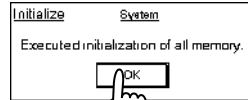

■ Save

This function saves the setting contents in all memories.

Be sure to “save” the setting change before turning off the system. Failure to do deletes all setting change when the system is turned off.

When re-starting up the system, the last setting contents (saved at last) appear. If all the settings are not saved, all of them are set to default value.

❗ CHECK

This function cannot save the status of “Timing Input” and “Hold” setting.

● How to use

- 1 Display the “Save” screen.

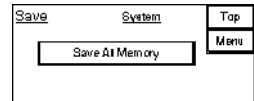

- 2 Touch the key.
The confirmation message appears.

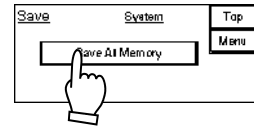

- 3 Touch the key.
The message of notifying the completion of save appears.
*Touch the key to cancel the save and return to step 1.

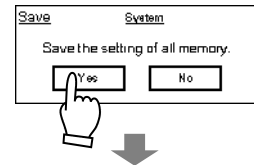

- 4 Touch the key.
Touch the key to return to the “System Menu 1/2”.

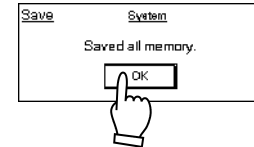

■ Communication: COM Port

This function specifies the baud rate, the data length, and parity for RS-232C communication.

These settings are used for communication with PC using RS-232C connector. Make sure to save the changed setting values, and then restart the power supply of the controller to validate the settings.

Setting item	Details
Baud rate	Sets the communication speed. Select from 9,600bps/19,200bps/38,400bps/115,200bps.
Data length	Sets the data bit number. Select from 7bit/8bit.
Parity	Sets the check bit for securing the reliability of communication. Select from even/odd/none.

For more further detail of RS-232C communication, refer to →“5-1 RS-232C Communication Control”.

● How to use

- 1 Display the “Communication: COM Port” screen.

Baud Rate setting

- 2 Touch the “Baud Rate” key to select the communication speed.

The display is changed as below each time the key is touched.

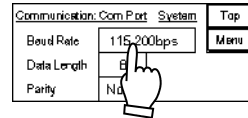
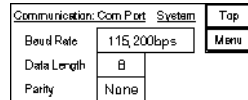
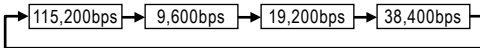

Data length setting

- 2 Touch the “Data Length” key to select the data length.

The display is changed between (8bit) and (7bit) each time the key is touched.

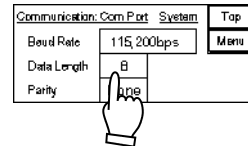

Parity Setting

- 2 Touch the “Parity” key to select the parity setting.

The display is changed as below each time the key is touched.

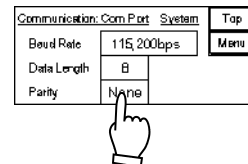
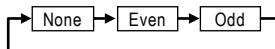

■RS-232C Output

This function is used for performance setting of the measurement data output from RS-232C to an external device.

● RS-232C Output mode

RS-232C output is selectable from three modes.

The initial value is set to “Handshake”.

Setting item	Contents
Handshake	In response to a request command from an upper device, transmits the result data as a reply command.
Timing	Transmits the measured value in the exclusive output format at timing input ON during Timing mode is selected.
Continuous	Transmits the measured value continuously in the exclusive output format after Continuous mode is selected.

Refer to the page 5-12 for details of the exclusive output format.

❗CHECK

Note that the command send/receive when RS-232C output mode is set to Continuous or Timing operates as the followings:

[RS-232C port]

Any other commands than “RS-232C Output Mode” is ignored. When “RS-232C Output Mode” is received, it transmits the reply and shifts to each mode.

[USB port]

Send/receive of all commands is available.

● RS-232C output type

When Timing or Continuous is selected for “RS-232C Output Mode”, an output destination of the measurement data is selectable from OUT1, OUT2, and both OUT1&OUT2.

The initial value is set to “OUT1”.

- How to use

- 1 Display “RS-232C Output” screen.

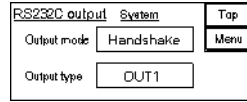

For RS-232C output mode:

- 2 Touch the “Output mode” key to select the output mode.

The display is changed as below each time the key is touched.

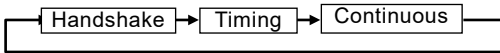
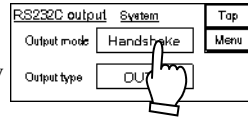

For RS-232C output type:

- 2 Touch the “Output type” key to select the output type.

The display is changed as below each time the key is touched.

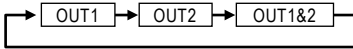
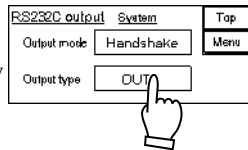

■ Console Setting

This function sets “Panel Lock” and “Start-up Screen” of compact programmable display.

Panel Lock

“Panel Lock” is used for prohibiting the setting change on the compact programmable display to prevent any setting error occurrence due to unintentional operation on the compact programmable display. When this function is set to “ON”, any operations except for screen display change and setting off of “Panel Lock” are prohibited.

* Save function, however, can be executed and the “Panel Lock” is valid at the next system start-up by saving the setting.

Start-up Screen

“Start-up Screen” is used for selecting the screen which is displayed after the wake-up screen of compact programmable display.

Select from 16 screens shown in the next page.

By selecting the screen that are often used or used for setting confirmation as a start-up screen, the setting steps can be shortened.

❗ CHECK

Make sure to save the setting to fix the selected start-up screen.

● How to use

- 1 Display the “Console Setting” screen.

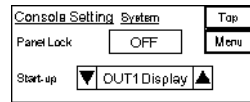

Panel Lock setting

- 2 Touch the Panel Lock key to select ON or OFF.

The key display is changed between ON and OFF each time the key is touched.

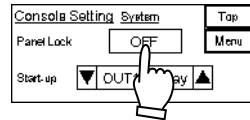

Start-up Screen setting

- 2 Touch the key of “Start-up” to select the screen which is displayed after the wake-up screen of compact programmable display.

The display is changed as below by touching the key. Also, the display is changed in counterclockwise by touching the key.

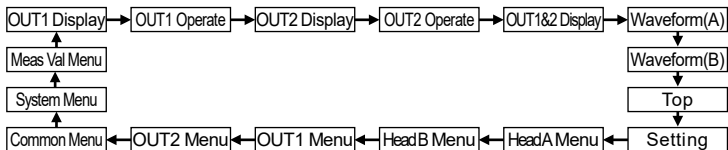
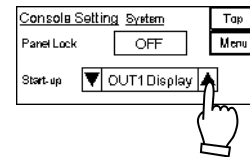

OUT1 Display

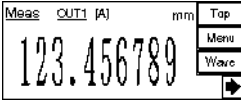

Displays the measurement value of OUT1.

OUT1 Operate

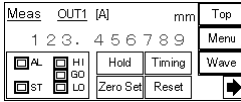

Sets the measurement value of OUT1, output (alarm, strobe, judgment output), and status of the hold, timing, zero set, and reset input.

OUT2 Display

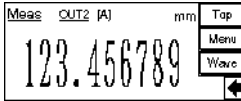

Displays the measurement value of OUT2.

OUT2 Operate

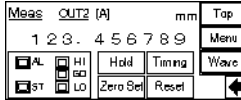

Sets the measurement value of OUT2, output (alarm, strobe, judgment output), and status of the hold, timing, zero set, and reset input.

OUT1&2 Display

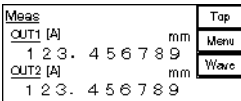

Simultaneously displays the measurement values of OUT1 and OUT2.

Waveform(A)

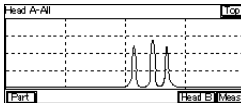

Displays the received light waveform of the sensor head A.

Waveform(B)

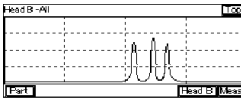

Displays the received light waveform of the sensor head B.

Top

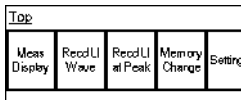

Displays the Top menu screen.

Setting

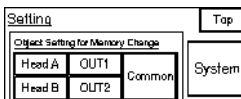

Displays the Setting menu screen.

Head A Menu

Head A Menu				Top
Instal Mode	Emise Adjust	Emt LI Search	Alarm Delay Times	↑ ← →
Meas Mode	Meas Suf Ref	Laser Control	Outbre-ton	

Displays the Head A Menu screen.

Head B Menu

Head B Menu				Top
Instal Mode	Emise Adjust	Emt LI Search	Alarm Delay Times	↑ ← →
Meas Mode	Meas Suf Ref	Laser Control	Outbre-ton	

Displays the Head B Menu screen.

OUT1 Menu

OUT1 Menu 1/2				Top
Output Selection	Analysis Mode	Filter Operate	Offset	↑ ← →
UpLo Lmt Val	UpLo Lmt Hys	Digit No Meas	Analag Scaling	

Displays the OUT1 Menu 1/2 screen.

OUT2 Menu

OUT2 Menu 1/2				Top
Output Selection	Analysis Mode	Filter Operate	Offset	↑ ← →
UpLo Lmt Val	UpLo Lmt Hys	Digit No Meas	Analag Scaling	

Displays the OUT2 Menu 1/2 screen.

Common Menu

Common Menu				Top
Sampling Cycle	Terminal Input Control	Chet Per for Term I/F	Judgment Output Off Delay	↑ ← →
Inf Prev				

Displays the Common Menu screen.

System Menu

System Menu 1/2				Top
Output Settings Copy	Priority Set of Mem.Ord	Memory Copy	Initialize	↑ ← →
Save	Com	Update Cycle of Meas-Val	Console Setting	

Displays the System Menu 1/2 screen.

Meas Val Menu

Measurement Value Menu				Top
Measurement Value Display				
OUT1 Display	OUT2 Display	OUT 1&2 Display	Digit No	↑ ← →
OUT1 Operat	OUT2 Operat	Display	Update Cycle	

Displays the Measurement Value Menu screen.

4

4-3-5 Buffering Setting

Buffering is a function for accumulating the measurement data in the controller memory and loading them to the external control device (PC).

Maximum 65,000 measurement data can be temporarily accumulated in the controller memory before loading them to PC. All accumulated data can be loaded by using the communication control with RS-232C or USB, or Intelligent Monitor AiM.

TECHNIQUE

With an optional Intelligent Monitor AiM, accumulation and loading of the measurement data can be executed easily by mouse operation. This Intelligent Monitor AiM is also useful for confirmation or verification of the measurement data because it can convert the data into CSV data format. CSV data can be used for graphic display, save, replay of the measurement data, and it can be opened in Microsoft Excel application.

Supplemental remarks

For buffering by RS-232C communication, refer to →“HL-C2 Series USER’S MANUAL RS-232C Communication Control” – “Chapter 5 Buffering Command”.

For buffering by USB communication, refer to →“HL-C2 Series USER’S MANUAL USB Communication Control” – “2-2-6 Setting (Buffering)”.

CHECK

A program is required for executing buffering by communication control with RS-232C or USB.

■ Data Buffering Operation

Data buffering procedure

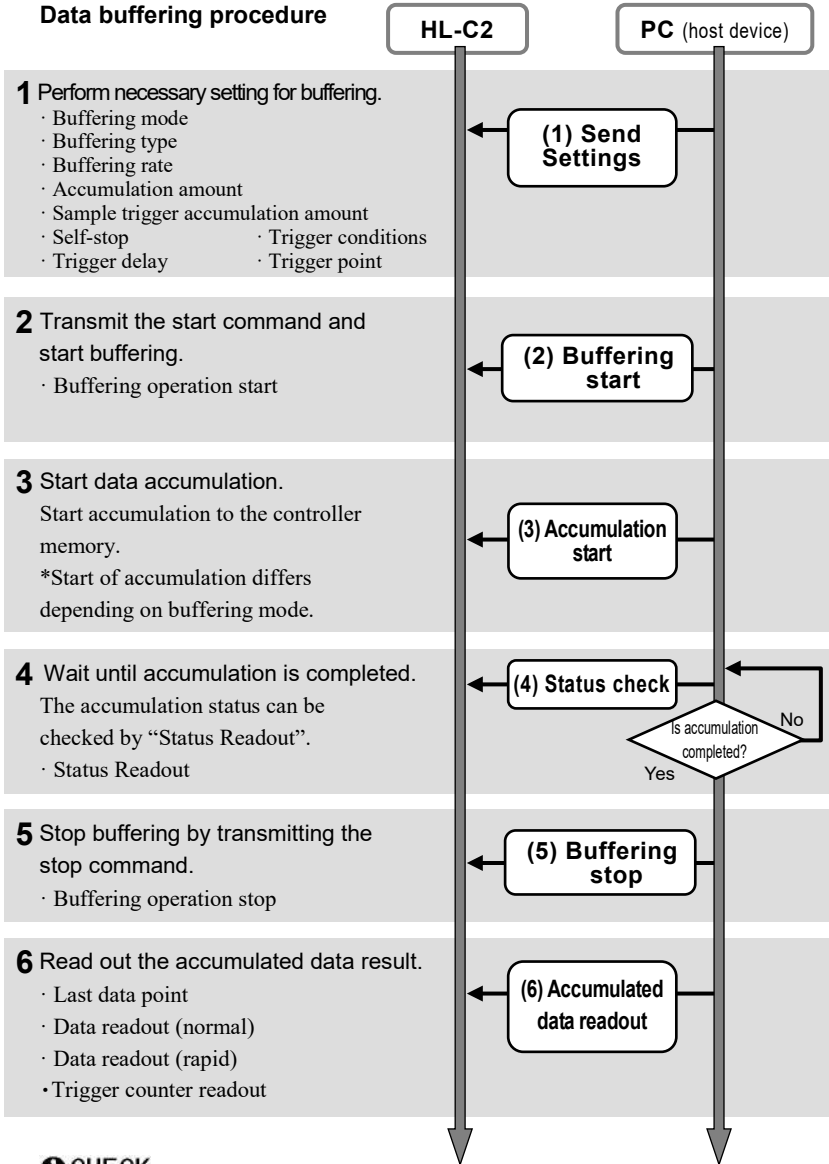

❗ CHECK

All the settings related to buffering cannot be changed during the buffering operation. Change the settings after buffering operation stops.

■ Buffering Operation

This function accumulates the data during buffering operation.

Set necessary parameters in advance and start buffering operation.

❗ CHECK

- The starting of the buffering operation requires the buffering type and the accumulation amount to be set within the setting range.
- All settings related to buffering cannot be changed during buffering operation.
- Non-buffering status cannot be set by only stopping the buffering operation.

■ Self-stop

This function stops the buffering operation automatically at completion of accumulation.

When the Self-stop function is set to ON (buffering operation is automatically stopped), stop input for buffering operation becomes unnecessary. This function is valid when the buffering mode is set to the continuous mode, trigger mode, or sample mode. This function is invalid when the timing mode is selected. When OUT1/OUT2 is set for the buffering type, this function operates immediately after completion of accumulation for OUT1/OUT2. When OUT1&OUT2 is selected, the self-stop function operates at completion of accumulation for both OUT1&OUT2.

■ Buffering Mode

Four types of buffering mode can be selected.

“Continuous Mode” is set as a default.

Continuous Mode

- When buffering operation starts, data accumulation to the controller memory also starts.
- Accumulation stops when the accumulation amount has reached the setting value or when buffering operation stops.

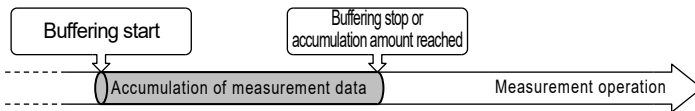

Trigger Mode

- When buffering operation starts, the trigger generation is turned to stand-by status.
- The measurement data before and after the trigger point where the trigger is generated is accumulated into the controller memory.
- Accumulation stops when the accumulation amount has reached the setting value or when buffering operation stops.

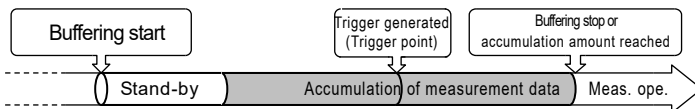

Timing Mode

- When buffering operation starts, the timing input is turned to stand-by status.
- Changing the timing input from “ON” to “OFF” during stand-by status starts data accumulation to the controller memory.
- Timing input stops when the accumulation amount has reached the setting value or when buffering operation stops.

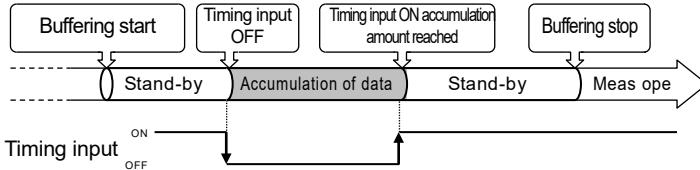

❗ CHECK

Changing the timing input from “ON” to “OFF” again deletes the previous data and starts new data accumulation. Make sure to stop the buffering operation once and load/save the accumulated measurement data before performing the next accumulation.

4

Sample Trigger Mode

- When buffering operation starts, the trigger generation is turned to stand-by status.
- Accumulation of the measurement data for the setting sample trigger accumulation amount starts after the setting trigger condition is generated.
- After completion of sample trigger accumulation, the trigger generation is turned to stand-by status again.
- When the setting trigger condition is generated again, accumulation of the setting sample trigger amount starts.
- Accumulation operation stops when the accumulation amount has reached the setting value or when buffering operation stops.

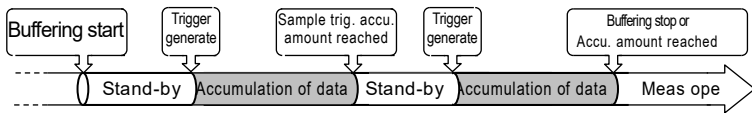

❗ CHECK

Be sure to set the sample trigger accumulation amount so that (accumulation amount) ÷ (sample trigger accumulation amount) is an integer value.

■ Buffering Type

This function selects individual data accumulation or simultaneous data accumulation on OUT1 and OUT2.

OUT1 is set as a default.

❗ CHECK

The maximum accumulation data amount differs depending on buffering type.

■ Buffering Rate

The buffering rate can be set for accumulating the measurement data for a long-duration by taking an adequate interval to the sampling cycle.

Select from 1 (All measurement data), 1/2, 1/4,to 1/32768.

1 (All measurement data) is set as a default.

(If selecting 1/4, the measurement data is accumulated only at once in four sampling cycles.)

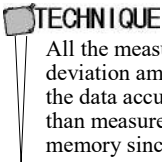

All the measurement data can be accumulated, however, in case that the deviation amount of the measurement data is small to a sampling cycle, setting the data accumulation interval can execute a long-duration data accumulation than measurement at every sampling cycle. This is useful for the effective use of memory since the data accumulation amount is limited.

■ Accumulation Amount

This function sets the accumulation amount of the measurement data.

Specify the accumulation amount within 1 to Max. accumulation amount.

Maximum accumulation amount is different between two buffering types.

OUT1 or OUT2 Max accumulation amount = 65,000 data

OUT1 & OUT2 Max accumulation amount = 32,500 data

“20000” is set as the default.

❗ CHECK

Accumulation cannot be started when the setting of the range of “accumulation amount” for each “buffering type”, settings of “trigger point” and “sample trigger accumulation amount” corresponding with the “accumulation amount” are not correct (out of the setting range).

■ Trigger Conditions

This function is used for setting the trigger generation conditions when the buffering mode is set to trigger mode or sample trigger mode.

The trigger conditions are selectable from “At timing input ON”, the results of “judgment output” (HI, LO, HI or LO, HI to GO, LO to GO, HI or LO to GO), “At an alarm occurred”, and “At an alarm released”.

The initial value is set to “At timing input ON”.

❗ CHECK

- Note that the settings of “Upper Limit/Lower Limit Value of Judgment Output” and “Upper Limit/Lower Limit Hysteresis of Judgment Output” become effective when the result of judgment output is set as a trigger condition.
- Note that the setting of “Number of Alarm Delay Times” becomes effective when “At an alarm occurred” is set as a trigger condition.

Ex) When the “Buffering Mode” is set to trigger mode, the operations of each trigger condition are shown as follows:

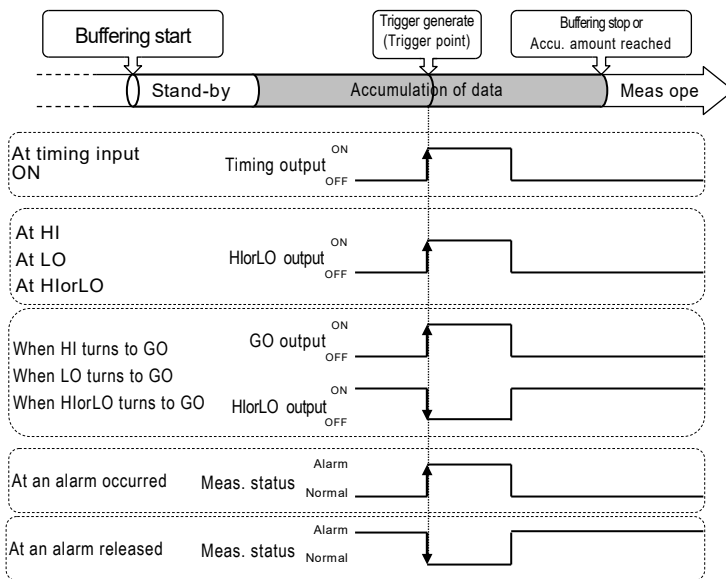

■ Trigger Delay

This function is used for delaying the timing of trigger detection when the buffering mode is set to trigger mode or sample trigger mode.

Sets number of sampling times as the trigger delay value. Setting range is 0 to 100000000.

The status during the trigger delay is indicated as “Accumulating”. The initial value is set to “0”.

For trigger mode:

Loads the measured data from the actual trigger generated point to the delayed trigger point that has been set for this function.

For sample trigger mode:

Starts accumulation of the measured data from the delayed trigger point that has been set for this function after the trigger was generated. The function ignores even if a new trigger is generated during the trigger delay operation.

❗ CHECK

When the buffering rate is already set, the trigger delay is counted with the extended sampling in accordance with the setting.

■ Trigger Point

When the buffering mode is set to trigger mode, the measurement data can be loaded by setting the data at the trigger generated as a trigger point.

Setting range is 1 to setting “accumulation amount”.

The initial value is set to “10000”.

❗ CHECK

- If the “trigger point” is set to a larger value than the setting “accumulation amount”, accumulation cannot be started.
- When the “Trigger Delay” function is set, the measurement data from the trigger delayed data point after the setting trigger is generated can be loaded.

■ Sample Trigger Accumulation Amount

When the buffering mode is set to sample trigger mode, the sample trigger accumulation amount can be set at every trigger generation.

Setting range is 1 to setting “accumulation amount”. The initial value is set to “1”.

❗ CHECK

Be sure to set the sample trigger accumulation amount so that (accumulation amount) ÷ (sample trigger accumulation amount) is an integer value.

■ Status Readout

This function checks the status of the measurement data accumulation.

Use this function for checking the accumulation status before reading the accumulated data. After having checked the status, the controller replies one of the next status.

Status	Contents
Non-buffering	Buffering operation is not executed at all after turning on the power supply or after initialization, or buffering operation is stopped while waiting for trigger after buffering has started.
Wait for trigger	Wait for trigger status after buffering operation has started.
Accumulating	Buffering operation has started and measurement data is being accumulated, or trigger has being generated and measurement data is being accumulated.
Accumulation completed	Accumulation amount has reached the setting value or the buffering operation has stopped.

4

■ Final Data Point

The accumulation status can be read from the data amount.

“Final Data Point” is set to “0” when the “Status Readout” is set to “Non-buffering”.

■ Trigger Counter Readout

When the buffering mode is set to sample trigger mode, the number of times of the final trigger generation can be read out.

❗ CHECK

When readout of the trigger counter is performed, stop the data accumulation operation and confirm the “Final Data Point”. If the result of “Status Readout” is indicated as accumulation completed and the “Final Data Point” is any values other than “0”, readout of the trigger counter can be started.

■ Data Read

The accumulated measurement data in the controller memory can be read out.

The below shows two reading methods.

Read method	Contents
Normal read	Simply reads the accumulated measurement data as is.
Rapid read	Reads the accumulated data by the difference from the previous data. Since data with less difference decreases with decreasing variation, the total transmission data amount decreases and the communication time is shortened.

① CHECK

To read the buffering data, stop buffering operation and check the “Final Data Point”. The accumulated data to the final data point can be read only when the result of “Status Readout” is “Accumulation Completed” and the final data point is the value “other than 0”.

4-4 Supplemental Explanation

This section provides supplemental explanation for enhancing understandings of the system functions.

4-4-1 Alarm Setting and Outputs

“Alarm status” means the measurement disabled status due to poor light intensity or out of measurement range.

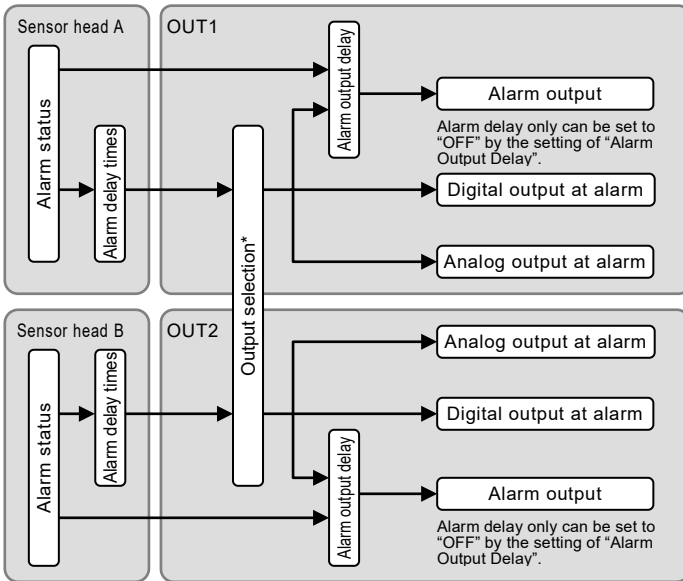

*1 In case of selecting “A+B” for the output selection, an alarm is output when either of the sensor head A or B goes into an alarm status.

	Function
Alarm Delay Times	Holds the previous normal value up to the setting number of times when an alarm is issued. Refer to → “Alarm Delay Times”.
Digital Output at Alarm	Sets the measurement value display in case that an alarm status continues more than the setting number of times. Refer to → “Digital Output at Alarm”.
Analog Output at Alarm	Sets the analog output value in case that an alarm status continues more than the setting number of times. Refer to → “Analog Output at Alarm”.
Alarm Output Delay	Enables the alarm output at a real time regardless of the alarm delay times. Refer to → “Analog Output Delay”.

4-4-2 Conditions When Output Data become Unfixed

At immediately after change of “head Setting” or “OUT Setting”, or when the reset or laser emission stop is input, the operation status becomes “Data unfixed status” (data is not determined). This status is not an alarm status.

The data unfixed status starts at the measurement re-start after the setting change or executing reset, and then, stops when the average times of data is reached.

Under data unfixed status, the display of the compact programmable display is -999.999999[mm], the analog output is -10.800[V]*1, the judgment output is set to OFF, and the strobe output is set to OFF.

*1 This is the initial value. Under data unfixed status, the analog output can be changed to the fixed value. Refer to →“Analog Output at Data Unfixed”.

*2 Under data unfixed status, the zero set input is ignored.

*3 For releasing the data unfixed status, refer to →“Chapter 7 Troubleshooting”.

For example, the right figure shows the digital display at reset input for normal measurement.

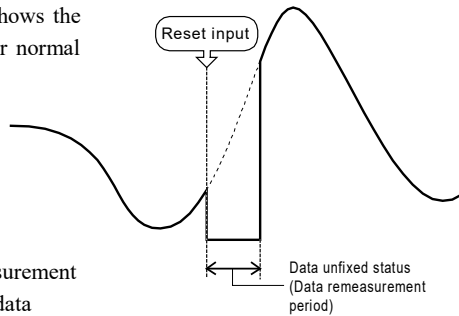

The below table shows the measurement value display and output under data unfixed status or alarm status.

	Data unfixed status	Alarm status
Status	Measurement data is unfixed. (Average buffer has not reached the setting number of times.)	Measurement disabled status due to poor light intensity or when a target object goes off the measurement range.
Meas val display on compact programmable display	-999.999999[mm]	Hold previous value (default)
Judgment output	OFF	Interlocks with the digital output
Alarm output	Interlocks with the alarm status	ON
Strobe output	OFF	ON

Alarm Code

In case an alarm occurs, check the alarm code of alarm output read by RS-232C or USB communication.

Alarm code	Name	Description
0	Normal	Normal measurement status.
1	Measurement alarm	Measurement is not possible due to insufficient light intensity, or when the measurement surface specified by the transparent object setting cannot be detected or under any other circumstances where the setting and the actual condition do not match. ⇒ Check the mounting condition and setting so that the light intensity is sufficient.
3	Controller Memory Error 1	The alarm occurs when saved settings cannot be retrieved during startup. ⇒ Turn the power off and on again. If this alarm still occurs, it is likely that saved settings have been destroyed. Thus, initialize all memories and save it. Then, turn the power on again. In this case, saved settings will return to default settings.
4	Controller Memory Error 2	The alarm occurs when settings cannot be saved. ⇒ Execute "save" again.
5	Sensor head unconnected	Sensor head A and B are unconnected, or sensor head is connected to HEAD B in the case of using only one sensor head. This alarm also appears when the cable for connecting sensor head is disconnected. ⇒ Connect the sensor head to HEAD A when using only one sensor head. If this alarm code appears again in spite of correct connection, the connecting cable may be disconnected. Please contact our sales person in charge.
6	Sensor head unadapted	The export controlled sensor head is connected to the export uncontrolled controller. ⇒ Connect in the correct combination.
7	Head connection check error	Controller is not recognizing sensor head correctly. Sensor head is not operating properly due to external noises or sensor head is malfunctioning. ⇒ Carry out measures to noise then restore the power.
8	Automatic Head Adjustment Error	The darkness level of received light waveform cannot be recognized correctly. Normal startup is interfered possibly by extraneous light or external noise. ⇒ Check use environment (extraneous light, for example), take measures against noise, and turn the power on again.
9	Head System Error	The sensor head system does not work properly. The inner part of the sensor head is possibly damaged. ⇒ The sensor head has possibly failed. Contact our sales person in charge.

Refer to → “7-1 Corrective Actions”.

The conditions of causes of data unfixed status and the measurement status are shown as below.

Conditions when output data become unfixed status	Measurement status
Remote interlock is input at power-on	Both OUT1 and OUT2 become the data unfixed status.
“Sampling Cycle” setting is changed.	
“Initialization”	
“Laser Emission Stop” is input.	The sensor head which is set at the output selection for each OUT becomes data unfixed status. EX In case that A+B is set for OUT1, -B is set for OUT2, and the setting of sensor head A is changed, OUT1 becomes the data unfixed status, and OUT2 continues the measurement.
“Installation Mode” setting is changed.	
“Measurement Mode” setting is changed.*	
“Measurement Surface Reference” setting is changed.	
“Calibration” setting is changed.	
“Output Selection” setting is changed.	
“Transparent Object”, “Refractive Index”, and “Refractive Index Calculation” settings are changed.	When changing the setting of OUT1, OUT1 becomes the data unfixed status, and OUT2 continues the measurement. In the same manner, when changing the setting of OUT2, OUT2 becomes the data unfixed status, and OUT1 continues the measurement.
“Analysis Mode” setting is changed.	
“Average Times” setting is changed.	

*There are cases where the data unfixed status does not occur depending on the setting conditions.

4-4-3 Memory Save and Terminal Setting

The setting contents for each function can be stored in 16 different patterns in the controller memory.

This function stores the measurement or judgment conditions for each measurement object respectively, so without re-inputting of various function setting, the condition change can be performed only by changing the memory No. “Memory change” can be executed by “Compact Programmable display” or “External Terminal Input (M0 to M3)”.

■ Storable Functions in Memory

The function settings which can be stored in the memory are divided into two types. One is the function which can be stored in each specified memory No., and another is the function which can be stored as common setting value among all memories. For the detail of the above two type storable functions, refer to →“4-3 Function List & Initial Values”.

■ Memory Change Procedure by External Input Terminal

- 1 Select Memory No. to be stored.
For setting by compact programmable display, refer to →“4-3-4 System Setting” – “Memory Change”.
- 2 After selecting memory No., input the setting value for each function.
For memory changeable functions, refer to →“4-3 Function List & Initial Values”.
- 3 Set “Terminal” at “Priority Setting of Memory Change”.
For “Priority Setting of Memory Change”, refer to →“4-3-4 System Setting” – “Priority Setting of Memory Change”.
- 4 Execute all memory save.
If not doing so, “Terminal” cannot be set.
For “Save” function, refer to →“4-3-4 System Setting” – “Save”.
- 5 Set the memory No. to be used to the external terminal input (M0 - M3).
*The setting can be input by manually on the compact programmable display, or by the command of RS-232C and USB communication control, or Intelligent Monitor AiM.

With the above five steps, the memory No. change can be performed by the external input terminal.

■ External Input Terminal Setting

Memory No.	External input terminal			
	M0	M1	M2	M3
0	OFF	OFF	OFF	OFF
1	ON	OFF	OFF	OFF
2	OFF	ON	OFF	OFF
3	ON	ON	OFF	OFF
4	OFF	OFF	ON	OFF
5	ON	OFF	ON	OFF
6	OFF	ON	ON	OFF
7	ON	ON	ON	OFF
8	OFF	OFF	OFF	ON
9	ON	OFF	OFF	ON
10	OFF	ON	OFF	ON
11	ON	ON	OFF	ON
12	OFF	OFF	ON	ON
13	ON	OFF	ON	ON
14	OFF	ON	ON	ON
15	ON	ON	ON	ON

MEMO

4

5

External Communication Control

This chapter explains control method of system by
RS-232C/USB/Ethernet communication.

5

5-1 Communication Control by RS-232C	5-2
5-1-1 Specifications	5-2
5-1-2 Type and Format of Commands	5-5
5-1-3 Command List	5-14
5-2 USB Communication Control	5-24
5-3 Ethernet Communication Control	5-26

5-1 Communication Control by RS-232C

5-1-1 Specifications

■ Communication Specifications

The specifications related to communication are listed in the table below. The configurations can be changed to the requirements of external host device.

Item	Settings	Default
Communication speed	9,600/19,200/38,400/115,200 bps	115,200 bps
Communication system	Full-duplex	-
Synchronization system	Asynchronous	-
Transmission code	ASCII	-
Data length	7 bit/8 bit	8 bit
Parity check	Even/Odd/None	None
Stop bit length	1 bit	-
End code	CR(0DH)	-
BCC	Yes ^{*1}	-

*1 To omit BCC calculation, enter "***" (2AH, 2AH) to BCC.

■ Pin Arrangement

The system uses a D-SUB male connector with 9 pins.

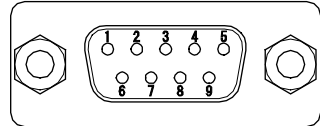

Pin No.	Signal name	Signal direction		Description
		HL-C2	Host	
1	CD(DCD)	Not used		-
2	RD(RxD)	IN	← OUT	Received data signal Usually connected to SD(TXD) of external device.
3	SD(TxD)	OUT	→ IN	Transmitted data signal Usually connected to RD(RXD) of external device.
4	ER(DTR)	Not used		-
5	SG(SG)	← Connected →		Signal ground Usually connected to SG(SG) of external device.
6	DR(DSR)	Not used		-
7	RS(RTS)	Not used		-
8	CS(CTS)	Not used		-
9	CI(RI)	Not used		-

■ Connecting Example with External Device

- Configuration

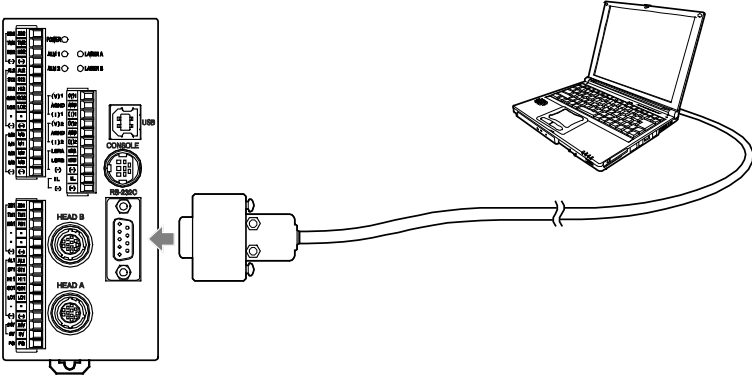

- Connection

HL-C2 and external host device should be connected as below.

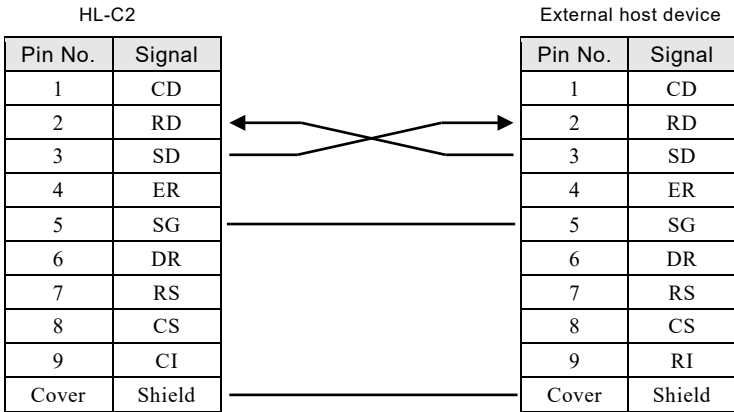

❶ CHECK

Signals other than RD, SD, SG and Shield should be kept unused. Do not connect with HL-C2.

■ Communication Procedures

- Configure communication specifications

1. Configure communication specifications of HL-C2

The communication specifications of RS-232C on HL-C2 are listed in the table in “5-1-1 Communication Specifications”. Set them according to situations.

2. Configure communication specifications of host device

Read the manuals related to the communication specification of external host device before setting them. Change the specifications so they will be the same as the settings of HL-C2, or set the specifications on HL-C2 according to the settings on the external host device.

■ Change of Communication Conditions

After changing the settings of communication conditions on baud rate, data length or parity check, make sure to save the new setting values and then restart the controller to reflect them.

5-1-2 Type and Format of Commands

■ Data Transmission/Reception

● Data transmission/reception

This section explains how to set or change various parameters or to confirm or read measurement values by sending a command from the external host device to HL-C2.

(1) Normal sequence to read setting data

The figure below shows the data transmitting/receiving sequence in case the request communication data instructing setting data read (in this case the head character of the command on the request communication data is “R”), which is transmitted from the external host device to HL-C2, is normal.

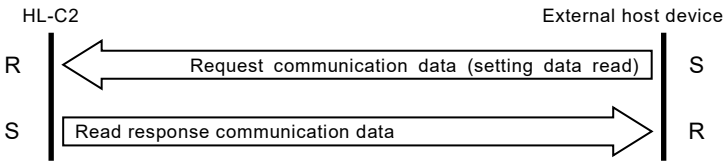

(2) Normal sequence to transmit/receive data on data setting or operation instruction

The figure below shows the data transmitting/receiving sequence in case the request communication data related to data setting or operation instruction (in case the head character of the command on the request communication data is “W”), which is transmitted from the external host device to HL-C2, is normal.

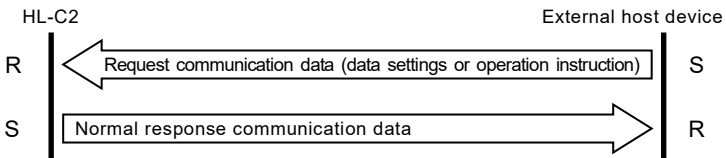

(3) Abnormal sequence to transmit/receive data

The figure below shows the data transmitting/receiving sequence in case the request communication data transmitted from the external host device to HL-C2, is abnormal such as data range error or garbled characters.

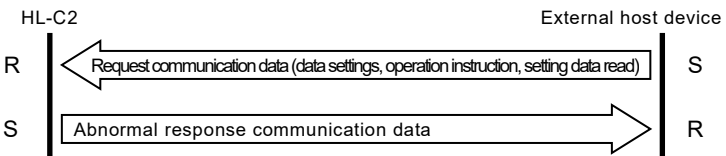

• Error code

Code No.	Code type	Description
01	Format error	The first four characters are not [%E E #].
02	Command error	The command is undefined.
03	Command code error	The forth character from the head is neither [R] nor [W].
04	Code error	The code is other than that specified per the command.
05	Data error	The data length does not correspond to the command.
07	Setting error	The setting for the command is out of the range.
08	BCC error	BCC check was not conformable.
10	Control flow error	<ul style="list-style-type: none"> · Memory Change command was received while “Terminal” was selected on “Priority Setting of Memory Change”. · Timing input was turned to OFF by a command while the timing input terminal is ON. · Timing input was turned to ON by a command while the timing input terminal is OFF.
11	Communication error	<ul style="list-style-type: none"> · A parity error occurred during data reception. · A framing error occurred during data reception. · An overrun error occurred during data reception.
20	Execution error	Calibration or analog scaling is inexecutable.
21	Buffering condition error 1	Setting of buffering was to be changed without stopping buffering operation.
22	Buffering condition error 2	Buffering operation was to be initiated with inadequate buffering setting.
23	Buffering condition error 3	<ul style="list-style-type: none"> · Data was read while buffering operation is “Start”. · Data was read while the status is other than “Accumulation Completed” status. · Data other than the read result of first data point to the final one was specified to be read.

! CHECK

- If an abnormal response is received, check if the transmitted data has errors. Correct them if it does. In case an error occurs on the system even the data has no errors, a temporary abnormal status due to noise or system abnormality on the controller or external host device may occur. Check them by restoring the power

■ Command Classification

● Communication data format

The figure below shows the basic format of request communication data and response communication data.

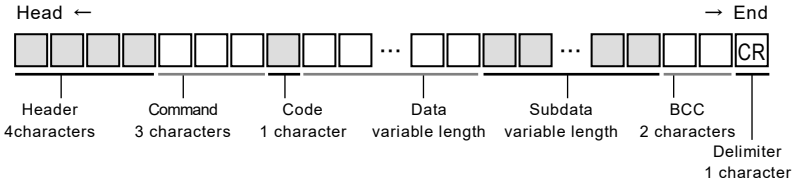

The specifications of respective sections are explained in the table below.

❗ CHECK

For ASCII and alphabetical characters, only capital characters can be used.

Section	Description
Header	This section indicates the type of communication data. % E E # : Request communication data % E E \$: Normal response communication data % E E ! : Abnormal response communication data
Command	This section specifies the command. 3-character command is specified to instruct operation to HL-C2. R * * : Read request (response) communication data W * * : Data setting request (response) → Refer to “5-3 Command List” for types of commands.
Code	This section indicates the identification code. It specifies the function classification and sensor head for the command. 0 : System 2 : Head B 4 : OUT2 1 : Head A 3 : OUT1 5 : Common The selectable code varies depending on the command. → Refer to “HL-C2 Series USER’S MANUAL RS-232C Communication Control” for the details.
Data	This section is used only to read buffering data.
Subdata	This section stores setting values and measurement values. This section is omitted in read request communication data command (R * * *) and write command (W * * *).
BCC	This is the block check code. The exclusive OR is executed from the header to final characters of communication data and 8-bit data is converted to 2-character ASCII code. BCC can be omitted at transmission by storing * * (2AH, 2AH). In this case, the BCC in the response data is * * (2AH, 2AH), too.
Delimiter	This code is used to identify the end of communication data (delimiter). It is fixed to CR (0DH).

■ Request Communication Data Format

This section explains the 6 format patterns of request communication data transmitted from the external host device to HL-C2.

● Read request

The figures below show the format for read request.

There are two types of pattern, depending on whether data section is included or not. The request communication data does not contain subdata section.

<Basic format: data section is not included>

FORMAT 1 Read request of setting data

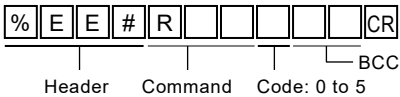

<Special format: data section is included (buffering)>

FORMAT 2 Normal read of buffering data

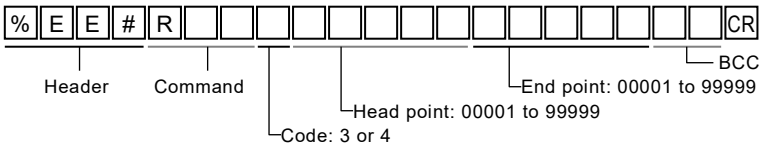

● Data setting request

The figures below show the format for data setting request.

The response communication data does not contain subdata section.

FORMAT 3 Code setting command

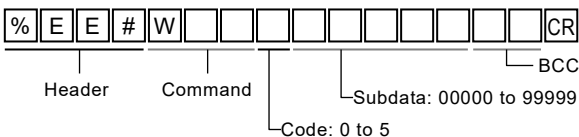

FORMAT 4 Value setting command 1

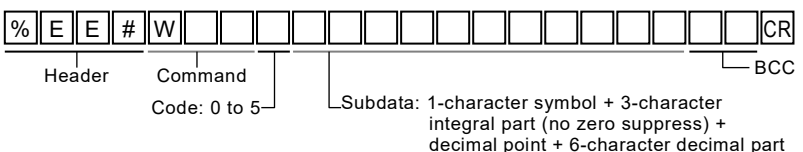

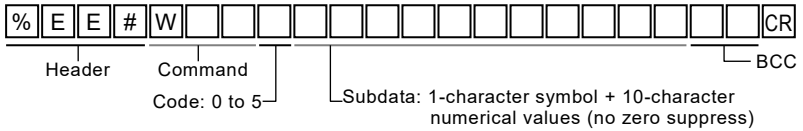
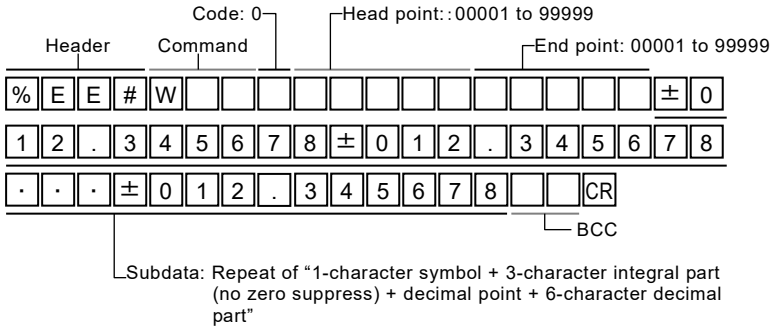
FORMAT 5 Value setting command 2**FORMAT 6** Normal write of buffering data

■ Response Communication Data Format

This section explains the 10 format patterns of response communication data transmitted from HL-C2 to the external host device.

- Read response

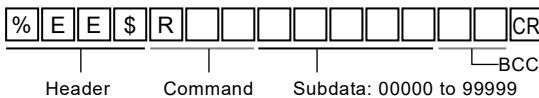
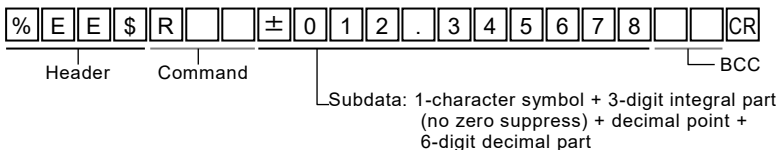
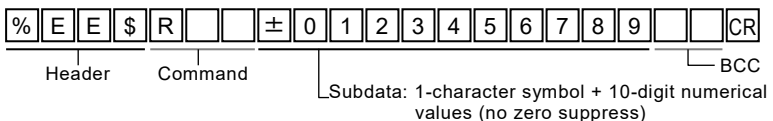
FORMAT 1 Read request of setting data**FORMAT 2** Format 2: Value read 1**FORMAT 3** Format 3: Value read 2

FORMAT 4 Special format 1:2 Output measurement value

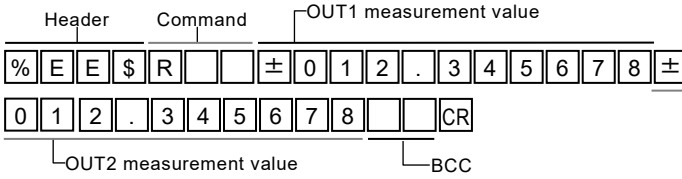

FORMAT 5 Special format 2:2 Output check

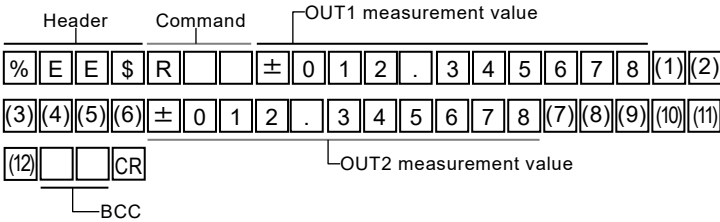

The measurement value consists of 1-character symbol, 3-digit integral part (no zero suppress), decimal point and 6-digit decimal part.

The following outputs are stored in (1) to (12) (OFF: / ON:).

No.	Output	
(1)	Strobe	
(2)	Judgment output	HI
(3)		GO
(4)		LO
(5)	Reserve	
(6)	Alarm	

No.	Output	
(7)	Strobe	
(8)	Judgment output	HI
(9)		GO
(10)		LO
(11)	Reserve	
(12)	Alarm	

CHECK

Response to (5) and (11) above are unfixed (either or .

FORMAT 6 Special format 4: Normal read of buffering data

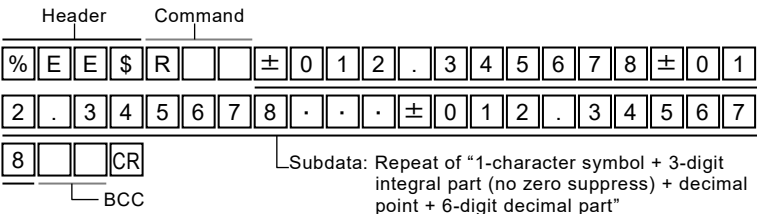

Subdata: Repeat of "1-character symbol + 3-digit integral part (no zero suppress) + decimal point + 6-digit decimal part"

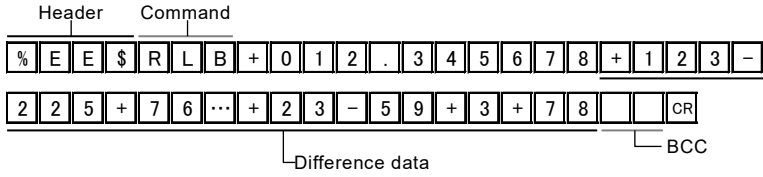
FORMAT 7 Special format 5: Read of differential data in buffering data

The data of specified head point is stored with the head data format shown below. For the data of second point and subsequent points, the differential by the previous data (the data based on the 6 places of decimals) is responded.

Head data format

- 1-character symbol + 3-digit integral part (no zero suppress)
- + decimal point + 6-digit decimal part

〈Example using the reply command shown above〉

+12.345678,	+12.345801,	+12.345576,	+12.345652,...	+12.345599,	+12.34554,	+12.345543,	+12.345621
↑	↑	↑		↑	↑	↑	
(+123)	(-225)	(+76)		(-59)	(+3)	(+78)	

FORMAT 8 Special format 7: Exclusive output format for RS232C output mode

For RS232C output type OUT1 or OUT2

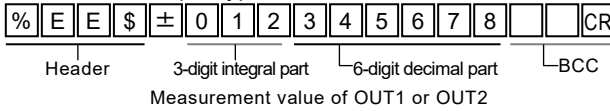

For RS232C output type OUT1&OUT2

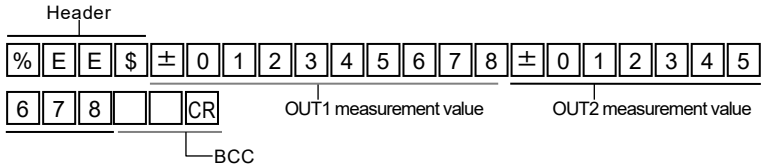

The measurement value consists of 1-character symbol, 3-digit integral part (no zero suppress), and 6-digit decimal part.

• Normal response

FORMAT 9 The normal response communication data for data setting request is common in all formats.

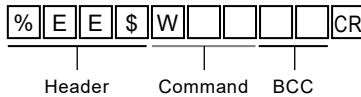

• Abnormal response

FORMAT 10 The abnormal response communication data is common in all formats.

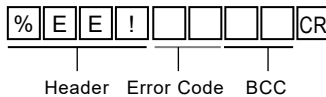

■ BCC

BCC is the code for horizontal parity check to improve the reliability of communication data. The exclusive logical sum from the header (☐%) to the final character of communication data is calculated and resultant 8-bit data is converted to 2-character ASCII code. The controller checks whether the exclusive logical sum of received message (from the header to the final character of communication data) is consistent with the value transmitted by the personal computer. The difference in BCC between at transmission and at receipt indicates that an error occurred in the message during communication. To omit BCC calculation, enter ☐*☐ (2AH, 2AH) to BCC. In this case, the BCC in the response data is ☐*☐ (2AH, 2AH), too.

❗ CHECK

For Special format 7 of FORMAT 8: As for the exclusive output format for RS232C output mode, the controller always delivers the measurement value attaching the BCC calculation result.

BCC creation example

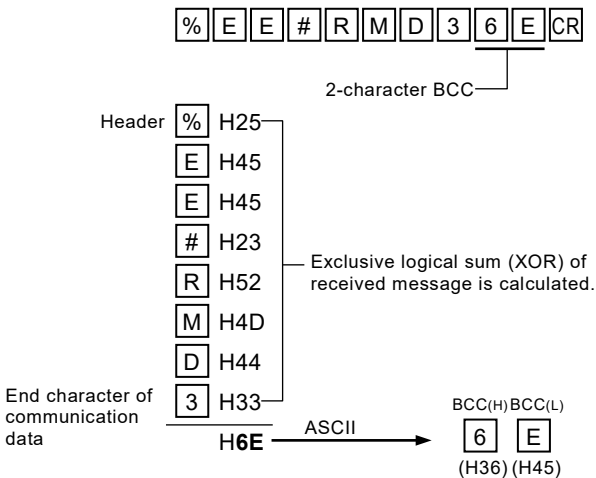

5-1-3 Command List

Refer to "HL-C2 Series USER'S MANUAL RS-232C Communication Control" for the details of respective commands.

Item		Command		Code	Subdata* ¹	Setting value
Head	Installation Mode	RMM	WMM	1/2	00000	Diffuse reflection
					00001	Specular reflection
	Emission Adjustment	RFB	WFB	1/2	00000	Auto
					00001	0.04%
					00002	0.05%
					00003	0.06%
					00004	0.08%
					00005	0.11%
					00006	0.14%
					00007	0.18%
					00008	0.24%
					00009	0.31%
					00010	0.40%
					00011	0.53%
					00012	0.68%
					00013	0.89%
					00014	1.16%
					00015	1.50%
					00016	1.95%
					00017	2.54%
					00018	3.30%
					00019	4.29%
					00020	5.58%
					00021	7.25%
					00022	9.43%
					00023	12.3%
					00024	15.9%
					00025	20.7%
					00026	26.9%
					00027	35.0%
					00028	45.5%
					00029	59.2%
00030	76.9%					
00031	100%					
Emission Adjustment Area	a	REA	WEA	1/2	-	00001 to 00512
	b	REB	WEB		-	00001 to 00512

*1 Subdata section consists of 5 digits (zero suppress is omitted) indicated by decimal.

Item		Command		Code	Subdata* ¹	Setting value	
Head	Emission Search	RFC	WFC	1/2	00000	None	
					00001	Execute	
					00002	Searching	
	Alarm Delay Times	RHC	WHC	1/2	-	00000: OFF to 65535: Hold Previous Normal Value	
	Measurement Mode	RSM	WSM	1/2	00000	Diffuse [Standard]	
					00001	Specular [Standard]	
					00002	Metal 1	
					00003	Metal 2	
					00004	Penetration	
					00005	Glass	
	Meas Surf Ref	RBF	WBF	1/2	00000	Near	
					00001	Far	
	Measuring Range	Point a	RPA	WPA	1/2	-	00003 to 00510
		Point b	RPB	WPB	1/2	-	00003 to 00510
	Calibration Meas. Value	A	RCA	WCA	1/2	-	-950.000000 to +950.000000 [mm]
		B	RCB	WCB	1/2	-	-950.000000 to +950.000000 [mm]
	Calibration Correct. Value	a	RHA	WHA	1/2	-	-950.000000 to +950.000000 [mm]
		b	RHB	WHB	1/2	-	-950.000000 to +950.000000 [mm]
	Calibration	-	WCE	1/2	00000	None	
					00001	Execute	
					00002	Cancel	
	Laser Control	RLR	WLR	1/2	00000	Laser ON	
					00001	Laser OFF	
Read Received Light Intensity	RID	-	1/2	-	00000 to 01023		
Peak Recognition Sensitivity	RTH	WTH	1/2	-	00100 to 00400		
Median Filter	RMF	WMF	1/2	00000	OFF		
				00001	7 point		
				00002	15 point		
				00003	31 point		

*1 Subdata section consists of 5 digits (zero suppress is omitted) indicated by decimal.

Item		Command		Code	Subdata ^{*1}	Setting value
OUT	Output Selection	ROS	WOS	3/4	00000	A
					00001	B
					00002	-A
					00003	-B
					00004	A+B
					00005	-(A+B)
					00006	A-B
					00007	B-A
					00008	[A] [Tr]
					00009	[B] [Tr]
					00010	[-A] [Tr]
					00011	[-B] [Tr]
					00012	A1+B1 [Tr]
					00013	-A1+B1 [Tr]
					00014	A1-B1 [Tr]
00015	B1-A1 [Tr]					
OUT	Transparent Object	RMN	WMN	3/4	00000	1st Surface
					00001	2nd Surface
					00002	3rd Surface
					00003	4th Surface
					00004	Up Lmt Surf
					00005	1st-2nd Surf
					00006	1st-3rd Surf
					00007	1st-4th Surf
					00008	1st-Up Surf
					00009	2nd-3rd Surf
					00010	2nd-4th Surf
					00011	2nd-Up Surf
					00012	3rd-4th Surf
					00013	3rd-Up Surf
00014	4th-Up Surf					
OUT	Refractive Index Calculation	RGK	WGK	3/4	00000	OFF
	00001	ON				
OUT	Refractive Index	RGR	WGR	3/4	-	+000.500000 to +002.000000
	00000	OFF				
OUT	Zero Set	RZS	WZS	3/4	00000	OFF
					00001	ON

*1 Subdata section consists of 5 digits (zero suppress is omitted) indicated by decimal.

Item		Command		Code	Subdata*1	Setting value
OUT	Timing	RTI	WTI	3/4	00000	OFF
					00001	ON
	Reset	RRS	WRS	3/4	00000	OFF
					00001	ON
	Hold	RHD	WHD	3/4	00000	OFF
					00001	ON
	Analysis Mode	RHM	WHM	3/4	00000	Normal
					00001	Peak
					00002	Bottom
					00003	Peak to Peak
	Filter Operation	RFL	WFL	3/4	00000	Moving Average
					00001	Low-pass Filter
					00002	High-pass Filter
	Average Times	RAV	WAV	3/4	00000	1 time
					00001	2 times
					00002	4 times
00003					8 times	
00004					16 times	
00005					32 times	
00006					64 times	
00007					128 times	
00008					256 times	
00009					512 times	
00010					1024 times	
00011					2048 times	
00012					4096 times	
00013	8192 times					
00014	16384 times					
00015	32768 times					
00016	65536 times					

*1 Subdata section consists of 5 digits (zero suppress is omitted) indicated by decimal.

Item	Command		Code	Subdata ^{*1}	Setting value	
Cutoff Frequency	RCO	WCO	3/4	00000	1[Hz]	
				00001	2[Hz]	
				00002	4[Hz]	
				00003	10[Hz]	
				00004	20[Hz]	
				00005	40[Hz]	
				00006	100[Hz]	
				00007	200[Hz]	
				00008	400[Hz]	
				00009	1000[Hz]	
00010	2000[Hz]					
Operation Coefficient	RMK	WMK	3/4	-	+000.100000 to +009.999999	
Offset	RML	WML	3/4	-	-950.000000 to +950.000000 [mm]	
Judgment Output Upper Limit Value	RHL	WHL	3/4	-	-950.000000 to +950.000000 [mm]	
Judgment Output Lower Limit Value	RLL	WLL	3/4	-	-950.000000 to +950.000000 [mm]	
Judgment Output Upper Limit Hysteresis	REH	WEH	3/4	-	+000.000000 to 950.000000 [mm]	
Judgment Output Lower Limit Hysteresis	REL	WEL	3/4	-	+000.000000 to 950.000000 [mm]	
Analog Scaling Measurement Value	A	RAH	WAH	3/4	-	-950.000000 to +950.000000 [mm]
	B	RAL	WAL	3/4	-	-950.000000 to +950.000000 [mm]
Analog Scaling Vol.	a	RVH	WVH	3/4	-	±010.000000[V]
	b	RVL	WVL	3/4	-	±010.000000[V]
Analog Scaling	-	WAS	3/4	00000	None	
				00001	Execute	
				00002	Cancel	
Analog Output at Alarm	RAA	WAA	3/4	00000	Hold Previous Value	
				00001	Fixed Value	
Fixed Value	RFM	WFM	3/4	-	±010.800000 [V]	
Analog O/P at Data Unfixed	RDA	WDA	3/4	-	±010.800000 [V]	
Digital Output at Alarm	RAD	WAD	3/4	00000	Hold Previous Value	
				00001	Fixed Value	
Alarm Output Delay	RAC	WAC	3/4	00000	OFF	
				00001	ON	

*1 Subdata section consists of 5 digits (zero suppress is omitted) indicated by decimal.

Item		Command		Code	Subdata*1	Setting value
OUT	Digit Number of Measurement Value	RKT	WKT	3/4	00000	6 Decimal Places
					00001	5 Decimal Places
					00002	4 Decimal Places
					00003	3 Decimal Places
					00004	2 Decimal Places
					00005	1 Decimal Places
	Measurement Value Read	RMD	-	3/4	-	-999.999999 to +999.999999 [mm]
	Alarm Output Read	ROA	-	3/4	00000	Alarm OFF
					00001	Measurement Alarm
					00005	Sensor head A unconnected
00006					Connection head unadapted	
00007					Head connection check error	
Strobe Output Read	ROB	-	3/4	00000	Strobe OFF	
				00001	Strobe ON	
Judgment Output HI Read	RHI	-	3/4	00000	Judgment Output HI OFF	
				00001	Judgment Output HI ON	
Judgment Output GO Read	RGO	-	3/4	00000	Judgment Output GO OFF	
				00001	Judgment Output GO ON	
Judgment Output LO Read	RLO	-	3/4	00000	Judgment Output LO OFF	
				00001	Judgment Output LO ON	
Common	Sampling Cycle	RSP	WSP	5	00000	10 [μs]
					00001	20 [μs]
					00002	40 [μs]
					00003	100 [μs]
					00004	200 [μs]
					00005	400 [μs]
					00006	1000 [μs]
					00007	2000 [μs]
	Terminal Input Control	RIM	WIM	5	00000	Independent
					00001	All
	Chattering Prevention for Terminal Input	RIC	WIC	5	00000	OFF
					00001	ON1
					00002	ON2

*1 Subdata section consists of 5 digits (zero suppress is omitted) indicated by decimal.

Item		Command		Code	Subdata* ¹	Setting value
Common	Judgment Output Off Delay	ROF	WOF	5	00000	OFF
					00001	2ms
					00002	10ms
					00003	100ms
					00004	Hold
	Interference Prevention	RXT	WXT	5	00000	OFF
					00001	ON
	2 Outputs Measurement Value Read	RMA	-	5	-	-999.999999 to +999.999999 [mm]
	All Outputs Read	RMB	-	5	-	One Time Read Output 1: Measurement value Strobe Output Judgment HI Output Judgment GO Output Judgment LO Output Reserve Output Alarm Output Output 2: Measurement value Strobe Output Judgment HI Output Judgment GO Output Judgment LO Output Reserve Output Alarm Output
	System	Output Setting Copy	-	WOC	0	00000
00001						Copy Output 1 to Output 2.
00002						Copy Output 2 to Output 1.
Priority Setting of Memory Change		RYU	WYU	0	00000	Command
					00001	Terminal
Memory Change		RMC	WMC	0	00000 to 00015	Memory No.
Copy Source No.		-	WSF	0	00000 to 00015	Memory No.
Copy Destination		-	WDF	0	00000 to 00015	Memory No.
Memory Copy		-	WCF	0	00000	None
					00001	Execute
Initialization	-	WIN	0	00000	None	
				00001	Initialize Selected Memory	
				00002	Initialize All Memory	

*1 Subdata section consists of 5 digits (zero suppress is omitted) indicated by decimal.

Item		Command		Code	Subdata* ¹	Setting value
System	Save	-	WWR	0	00000	None
					00001	Save All Memory
	RS-232C Baud Rate	RSA	WSA	0	00000	9600[bps]
					00001	19200[bps]
					00002	38400[bps]
					00003	115200[bps]
					00000	7-bit
	RS-232C Data Length	RSB	WSB	0	00001	8-bit
					00000	Even
	RS-232C Parity Check	RSC	WSC	0	00001	Odd
					00002	None
					00000	Handshake
	RS-232C Output Mode	RSD	WSD	0	00001	Timing
					00002	Continuous
					00000	OUT1&OUT2
	RS-232C Output Type	RSE	WSE	0	00001	OUT1 only
					00002	OUT2 only
					00000	Fast
	Display Update Cycle of Measurement Value	RKS	WKS	0	00001	Standard
					00002	Slow
					00003	Very Slow
					00000	mm Unit
	Change Indication Unit	RUT	WUT	0	00001	μm Unit
					00000	OUT1 Display
	Console Start-up Screen	RKG	WKG	0	00001	OUT1 Operation
					00002	OUT2 Display
					00003	OUT2 Operation
					00004	OUT1&2 Display
					00005	Waveform(A)
					00006	Waveform(B)
					00007	Top
					00008	Setting
00009					Head A Menu	
00010					Head B Menu	
00011					OUT1 Menu	
00012					OUT2 Menu	
00013					Common Menu	
00014					System Menu	
00015					Measurement Value Menu	
Console Panel Lock	RPL	WPL	0	00000	OFF	
				00001	ON	

*1 Subdata section consists of 5 digits (zero suppress is omitted) indicated by decimal.

Item	Command		Code	Subdata* ¹	Setting value	
Buffering	Self-stop	RSS	WSS	0	00000	OFF
					00001	ON
	Buffering Mode	RBD	WBD	5	00000	Continuous
					00001	Trigger
					00002	Timing
					00003	Sample Trigger
	Buffering Type	RTT	WTT	5	00000	OUT1 & 2
					00001	OUT1
					00002	OUT2
	Buffering Rate	RBR	WBR	5	00000	1
					00001	1/2
					00002	1/4
					00003	1/8
					00004	1/16
					00005	1/32
					00006	1/64
					00007	1/128
					00008	1/256
					00009	1/512
					00010	1/1024
					00011	1/2048
					00012	1/4096
					00013	1/8192
00014					1/16384	
00015	1/32768					
Accumulated Amount	RBC	WBC	5	-	1 to Max. Accumulated Amount	
Trigger Conditions	RTR	WTR	3/4	00000	At timing input ON	
				00001	At HI	
				00002	At LO	
				00003	At HI or LO	
				00004	When HI turns to GO	
				00005	When LO turns to GO	
				00006	When HI or LO to GO	
				00007	At an alarm occurred	
00008	At an alarm released					
Trigger Delay	RTL	WTL	5	-	+0000000000 to +0100000000	
Trigger Point	RTP	WTP	5	-	1 to Accumulated amount	
Sample Trigger Accumulation Amount	RSR	WSR	5	-	1 to Accumulated amount	
Buffering Operation	RBS	WBS	0	00000	Stop	
				00001	Start	

*1 Subdata section consists of 5 digits (zero suppress is omitted) indicated by decimal.

Item	Command		Code	Subdata* ¹	Setting value	
Buffering	Status Readout	RTS	-	3/4	00000	Non-buffering
					00001	Wait for Trigger
					00002	Accumulating
					00003	Accumulation Completed
	Final data point	RLD	-	3/4	-	Read One Time
Data Read (Normal)	RLA	-	3/4	-	5-character head point + 5-character end point Data point within the range from the head data point to the end data point is specified.	
Data Read (Rapid)	RLB	-	3/4	-	5-character head point + 5-character end point Data point within the range from the head data point to the end data point is specified.	
Trigger Counter Readout	RLE	-	3/4	-	0 to end data point	

*1 Subdata section consists of 5 digits (zero suppress is omitted) indicated by decimal.

5-2 USB Communication Control

HL-C2 can be controlled through the external host device (personal computer) through USB interface by using the API function. → Refer to “HL-C2 Series USER’S MANUAL USB Communication Control” in “our web site: <https://panasonic.net/id/pidsx/global>” (PDF data) for the details.

USB driver

USB driver should be installed to the external control device (personal computer) in order to control HL-C2 by external control device (personal computer).

You can download the USB driver from our Website.

→ Refer to “1-2 Installation of USB Driver” in “HL-C2 Series USER’S MANUAL USB Communication Control” for the installing method of USB driver.

API file

API (Application Program Interface) is provided to easily control HL-C2 by the external control device. API is provided in DLL format.

Please feel free to ask our salesman how to obtain a DLL file.

Please contact the vendor of development environment for the use of DLL. Refer to “Chapter 2 API Function Specification” in “HL-C2 Series USER’S MANUAL USB Communication Control” for the use of API.

■ Operating Environment

The following operating environments are required to use HL-C2.

Operating environment	
OS	Microsoft Windows® 7 Professional 32bit/64bit Microsoft Windows® 8.1 Pro 32bit/64bit Microsoft Windows® 10 Professional 32bit/64bit (Japanese, English, Chinese, Korean)
CPU	1GHz or more processor* ¹
Memory	2GB or more* ¹
USB Port	USB 2.0 Full Speed (USB 1.1 compatible) compliant

*¹ It depends on the operation environment of OS.

*Windows is a registered trademark of Microsoft Corporation in the United States and other countries.

■ Change RS-232C Communication Conditions

After changing the settings of communication conditions on baud rate, data length or parity check by API, make sure to save the new setting values and then restart the controller to reflect them.

■ Sample program

Sample program for USB control, which was created using API, is provided. We offer Sample program, which are for Visual Basic and Visual C++.

5-3 Ethernet Communication Control

The HL-C21C makes it possible to read a variety of settings and measured values over Ethernet communication. → Refer to “HL-C2 Series USER’S MANUAL Ethernet Communication Control” in “our web site: <https://panasonic.net/id/pidsx/global>” (PDF data) for the details.

■ Specifications of Ethernet Block

Interface		RJ45
Transmission specifications	Baud rate	10BASE-T / 100BASE-TX
	Transmission method	Baseband
	Max. segment length	100m
Support command		MEWTOCOL (Master) iQSS-supporting MC protocol communication (Sensor slave node) MC protocol (Master)
Support tool		Configurator WD (Ver. 1.62 or later)

*MEWTOCOL: Supports MEWTOCOL-COM communication.

*iQSS supporting: An iQ Sensor solution of Mitsubishi Electric Corp.

*MC protocol: Used to write data from the HL-C21C to memories of PLCs manufactured by Mitsubishi Electric Corp. This protocol supports QnA-compatible 3E frame commands.

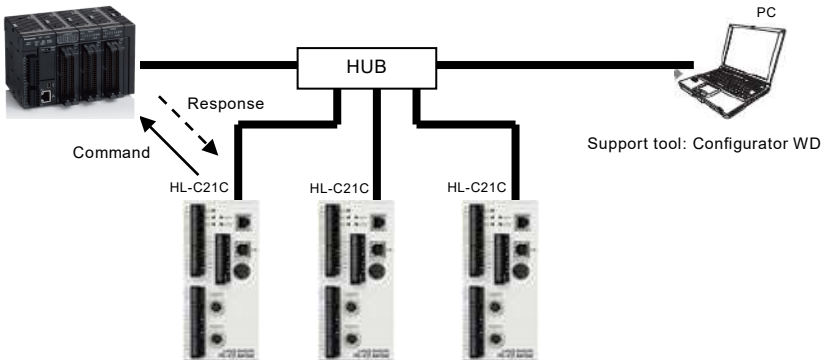

6

Maintenance and Inspection

6-1 Maintenance	6-2
6-2 Inspection	6-2

6-1 Maintenance

■ Maintenance Instructions

- Before cleaning the unit, be sure to turn off the power and stop laser emission.
- Molded resin is used in some parts of the unit. Do not use organic solvents such as thinner or benzene to wipe dirt on it.
- Do not wipe the glass portion of laser aperture too hard. Scratches on the glass may cause measurement errors.

(1) Cleaning of light emitter/receiver on the front surface of sensor head

- Measurement error may occur if oil, fingerprints, or other substances that refract light exists on the light emitting or receiving surface at the sensor head. Inspect the surfaces regularly and always keep them clean.
- To remove large particles of dust, blow them away using a camera lens blower.
- To remove small particles of dust or fingerprints, use soft lens cleaning cloth or lens cleaner paper to lightly wipe them out.
- Use cloth moistened with a small amount of alcohol to wipe out tough dirt carefully.

(2) Cleaning of other components

- To remove dirt on the controller or compact programmable display, lightly wipe it away with clean, soft cloth.

6-2 Inspection

Inspect the sensor unit regularly to ensure performance and to use it under optimum conditions.

■ Major Inspection Items

- Check that I/O terminal connections are not loose or disconnected.
- Check that the glass surface on the laser aperture is free from dust, dirt or fingerprints.
- Check that the power supply voltage is within the rated range (21.6 to 26.4VDC).
- Check that the ambient temperature during use is within the specification (sensor head: 0 to +45°C, controller: 0 to +50°C)
- Check that ambient humidity during use is within the range of 35 to 85%RH.

7

Troubleshooting

This chapter explains corrective actions against abnormal state.
Read this chapter if failures are suspected.

7-1 Corrective Actions	7-2
7-2 Lock	7-7
7-3 Initialization.....	7-7

7-1 Corrective Actions

In case an error or trouble occurs during use of the system or a system failure is suspected, read this chapter carefully first and carry out the corresponding corrective actions.

Trouble type

SET	Troubles in the settings of controller
COM	Troubles in communication control
MEAS	Troubles in measurement method or display of measurement value
LED	Troubles in LED indication of alarms and errors
TERM	Troubles in external terminal I/O
LASER	Troubles in laser emission

! CHECK

- Refer to → “4-1 Data Flow”, too for the problems related to measurement data processing.
- Refer to → “4-4-1 Alarm Setting and Outputs”, too for the problems related to alarms.
- Refer to → “4-4-2 When Output Data become Unfixed”, too for the details of conditions where measurement value is unfixed.
- Refer to → “4-4-3 Memory Save and Terminal Setting”, too for the problems related to storing memory and terminal settings.

Type	Problem	Cause	Corrective action	Ref. page
SET	<ul style="list-style-type: none"> · The display on the compact programmable display does not change. · The touch key on the compact programmable display does not operate. 	Connecting cable is not connected properly.	Check the connection between controller and cable.	1-2
		Connecting cable is disconnected.	Check the wiring between controller and cable.	1-14
	<ul style="list-style-type: none"> · ERFF is displayed at the upper right of the compact programmable display screen. · Sensor head indicator does not light up. · The controller does not operate. 	Power is not supplied to the controller.	Check the connection of controller and external power 24V DC.	1-15
		Controller operation is stopped.	Turn on the power of controller again.	3-6
SET	It takes too long until the controller starts or laser is emitted.	Usually about 25 to 30 seconds are required.	Wait for 40 seconds or more after power-on.	3-6
SET	Update cycle of measurement value is too late.	Update cycle of measurement value is not set correctly.	Set the Display Update Cycle of Measurement Value properly.	4-56

Type	Problem	Cause	Corrective action	Ref. page
LASER	Laser beam is not emitted.	Laser Control setting is saved with OFF.	Save the setting of Laser Control with ON.	4-16 4-65
		Laser control terminal is short-circuited.	Open the laser control terminal (LSRA or LSRB) .	2-2
		Remote interlock is open.	Short circuit the remote interlock .	23
		IL terminal and LSRA/LSRB terminal is disconnected.	Check the wirings of terminal block .	1-16 2-2
		The export controlled sensor head is connected to the export uncontrolled controller.	Connect the export uncontrolled sensor head to the export uncontrolled controller.	24
MEAS	There is a difference between actual distance to the measurement object and measurement value.	Calibration is not set correctly.	Set Calibration correctly.	4-17
		The measurement object is fluctuating or vibrating.	Stop fluctuation or vibration of measurement object.	1-10
		The measurement object is tilted.	Place the measurement object as perpendicularly as possible.	1-13
		Received light waveform is saturated or insufficient.	Adjust the received light intensity using Emission Adjustment .	4-10
		The refractive index is not correct.	Adjust the reflectance using Refractive Index Calculation .	4-24
MEAS	Measurement range is partially output.	Sensor head is not installed correctly.	Install the head correctly. Note that an installation method is different between specular reflection and diffuse reflection .	1-13
		Installation mode is wrong.	Set the correct installation mode (Specular Reflection or Diffuse Reflection).	4-7
		Is the measuring range set appropriately?	Set the measuring range appropriately.	4-16
MEAS	Correct measurement value is not displayed.	Measurement object is out of the measurement range.	Check the measurement range of sensor head used.	8-22
		Operation coefficient or offset is not set correctly.	Set Operation coefficient or offset correctly.	4-36 4-37
		Light emitter/receiver is dirt.	Remove the dirt on the light emitter/receiver .	9 1-7

Type	Problem	Cause	Corrective action	Ref. page
MEAS	Measurement values vary.	Moving Average is small.	Increase the number of Moving Average .	4-34
		Measurement mode is not set correctly.	Set the Measurement Mode according to applications or measurement object. Select the optimum mode.	4-8
		Light emitter/receiver is dirt.	Remove the dirt on the light emitter/receiver on the sensor head.	9 1-7
		Mounting direction of sensor head is wrong.	Check the mounting direction of sensor head .	1-10
		Sensor head or measurement object is tilted.	Check the installation of sensor head and position of measurement object.	1-10
COM	RS-232C communication control can not be done. An error is transmitted in RS-232C.	RS232C cable is disconnected.	Check the cable connection between RS232C cable and connector.	5-2
		RS232 cable type is improper.	Use the proper RS232C cable type , straight type or cross type, depending on the settings of personal computer.	5-3 1-2
		The setting of baud rate or communication specification is improper.	Check the settings of personal computer currently connected and set the correct RS232C communication specifications .	5-2
		Incorrect data format or command is transmitted.	Refer to the error codes and send the data with correct format and command.	5-6 5-8
		Several commands are sent continuously without waiting receiving responses from the controller.	Send the next command after the controller transmits the response to the previous command.	5-5
COM	USB communication control can not be done.	USB cable is disconnected.	Connect the USB cable securely.	1-2
		USB cable type is improper.	Use the USB2.0 full speed-compliant cable at USB2.0 interface .	8-3
		USB driver is not correctly installed.	Correctly install the USB driver . You can download the USB driver from our Website.	1-3
		The personal computer used does not satisfy the operating environment.	Use the personal computer satisfying the operating environment .	5-25

Type	Problem	Cause	Corrective action	Ref. page
<div style="border: 1px solid black; padding: 2px; display: inline-block; margin-bottom: 5px;">MEAS</div> <div style="border: 1px solid black; padding: 2px; display: inline-block; margin-bottom: 5px;">LED</div>	<p>Alarm indicator lights up and measurement can not be done.</p> <p style="text-align: center;">↓</p> <p>In case an alarm occurs, check the alarm code of alarm output read by RS-232C or USB communication.</p>	Head is not connected.	The alarm indicator lights up when the head is not connected.	1-2
		Beam emitting spot is out of the measurement range.	Move the measurement object so beam projection spot come within the measurement range to light up or blink the RANGE indicator on the sensor head.	8-22
		The reflected beam from the beam emitting spot is blocked.	Move the position of beam projection spot or change the mounting direction of sensor head so the reflected beam should not be blocked.	1-10
		The beam emitting spot is applied to the R portion (curved surface) of the measurement object.	Apply the beam projection spot to the top of R portion or adjust the beam diameter so it comes larger by moving the measurement object back and forth within the measurement range.	1-10
		The reflected beam has directionality because the surface of object is hairline-finished.	Check the mounting direction of sensor head.	1-10
		Extraneous light such as sunlight or light having the same wavelength as that of the laser is entering.	Take measures to prevent the entry of extraneous light, and turn the power back on.	4-86
		External noise is entering.	Take noise prevention measures, and turn the power back on.	4-86
		Received light intensity is insufficient because the sampling cycle is too short.	Set longer sampling cycle .	4-50
		Received light intensity is saturated because the sampling cycle is too long at specular reflection.	Set shorter sampling cycle or attach the ND filter .	4-50 1-13
		Diffuse Reflection is selected to measure the mirrored surface or transparent object.	Use the sensor head with Specular Reflection installation.	1-13
The export controlled sensor head is connected to the export uncontrolled controller.	Connect the export uncontrolled sensor head to the export uncontrolled controller.	24		

Type	Problem	Cause	Corrective action	Ref. page
<div style="border: 1px solid black; padding: 2px; display: inline-block;">SET</div> <div style="border: 1px solid black; padding: 2px; display: inline-block;">LED</div>	Measurement range indicator on the sensor head does not light up/blink.	Sensor head is not installed correctly.	Install the head correctly. The installation method is different between specular reflection and diffuse reflection.	1-13
		Installation mode is wrong.	Set the correct installation mode (Specular Reflection or Diffuse Reflection).	4-7
		Output selection is incorrect.	Check the setting in Output Selection. The measurement range indicator that is not selected in Output Selection is turned off.	4-20
		Is the measuring range set appropriately?	Set the measuring range appropriately.	4-16

Type	Problem	Cause	Corrective action	Ref. page
<div style="border: 1px solid black; padding: 2px; display: inline-block;">MEAS</div> <div style="border: 1px solid black; padding: 2px; display: inline-block;">LED</div>	Alarm indicator lights up and measurement can not be done. Measurement range is limited.	Sampling period is too long and this causes excessive received light intensity beyond the adjustable range.	Set shorter sampling period and reduce the emitted light intensity (enter a smaller number to “Emission Adjustment”).	4-50 4-10
		Specular reflection component is received during the measurement at diffuse reflection setting.	Adjust the mounting direction of the sensor head or change the tilt of the object so the beam receiver should not receive specular reflection component.	1-10
<div style="border: 1px solid black; padding: 2px; display: inline-block;">TERM</div>	Memory No. can not be changed from the terminal.	Wiring on terminal is disconnected.	Check the connection to Terminals from M0 to M3.	1-16 2-3
		“Command” is selected in “Priority Setting of Memory Change”.	Change the setting of “Priority Setting of Memory Change” to “Terminal”.	4-60
<div style="border: 1px solid black; padding: 2px; display: inline-block;">MEAS</div>	Others	Sensor head is connected to HEAD B only.	Connect the sensor head to HEAD A when using only one sensor head.	1-2

7-2 Lock

- “Panel Lock” is used for prohibiting the setting change on the compact programmable display to prevent any setting error occurrence due to unintentional operation on the compact programmable display.
- Set or release panel lock referring to “Panel Lock” (→ page 4-72).
- When this function is set to “ON”, any operations except for screen display change and setting off of “Panel Lock” are prohibited. Save function, however, can be executed and the “Panel Lock” is valid at the next system start-up by saving the setting.

7-3 Initialization

- Initialization deletes all settings and returns them to the factory default.
- Refer to “Initialization” (→ page 4-66) to initialize the system.
- After initialization, the default settings are not saved. Save the settings referring to “Save” (→ page 4-68) before turning off the system power in order to keep them valid after the next power-on.

MEMO

7

8

Specifications

This chapter describes the specifications of system components
(controller and sensor head).

8-1 Controller Specifications	8-2
8-2 Sensor Head Specifications	8-8
8-3 ND Filter Specifications	8-36
8-4 Outside Dimension	8-37
8-5 Characteristics	8-49

8-1 Controller Specifications

• RS-232C type

Model No.		HL-C2C(E)	HL-C2C(E)-P
Supply voltage		24VDC \pm 10% Including ripple 0.5V (P-P)	
Current consumption		Approx. 500mA at 2 sensor heads connected Approx. 350mA at 1 sensor head connected (Approx. 100mA is additionally required when the compact programmable display is connected.)	
Sampling cycle		10 μ s, 20 μ s, 40 μ s, 100 μ s, 200 μ s, 400 μ s, 1ms, 2ms	
Analog output	Voltage ^{*1}	Voltage output scale: -5 to +5V/F.S (initial value) Output range during normal status: -10.0 to +10.0V Output at abnormal status: -10.8V or +10.8V Resolution: 2mV, Linearity: \pm 0.05% F.S. Max. 2mA, output impedance 50 Ω , Response delay time: Approx. 1.5 μ s/V	
	Current ^{*2}	Current output scale: 4 to 20mA/F.S (initial value) Output range during normal status: 2 to 24mA Output at abnormal status: 1mA or 25mA Resolution: 3mA, Linearity \pm 0.05% F.S. Load impedance: 250 Ω max., Response delay time: Approx. 10 μ s	
Alarm output		NPN transistor open collector Maximum in-flow current: 100mA Applied voltage: 3 to 30VDC (ALARM output to Common(-)) Residual voltage: 1V or less (at in-flow current of 100mA) Leak current : 0.05mA or less	PNP transistor open collector Maximum out-flow current: 100mA Applied voltage: 3 to 30VDC (ALARM output to +V) Residual voltage: 1V or less (at out-flow current of 100mA) Leak current : 0.05mA or less
	Output operation	Open when the output is ON (Light intensity is insufficient).	
	Short circuit protection	Incorporated (Auto-reset)	
Judgment output (HI, GO, LO)		NPN transistor open collector Maximum in-flow current: 100mA Applied voltage: 3 to 30VDC (Judgment output to Common(-)) Residual voltage: 1V or less (at in-flow current of 100mA) Leak current : 0.05mA or less	PNP transistor open collector Maximum out-flow current: 100mA Applied voltage: 3 to 30VDC (Judgment output to +V) Residual voltage: 1V or less (at out-flow current of 100mA) Leak current : 0.05mA or less
	Output operation	Open when the output is ON (output operates).	
	Short circuit protection	Incorporated (Auto-reset)	
Strobe output		NPN transistor open collector Maximum in-flow current: 100mA Applied voltage: 3 to 30VDC (Strobe output to Common(-)) Residual voltage: 1V or less (at in-flow current of 100mA) Leak current : 0.05mA or less	PNP transistor open collector Maximum out-flow current: 100mA Applied voltage: 3 to 30VDC (Strobe output to +V) Residual voltage: 1V or less (at out-flow current of 100mA) Leak current : 0.05mA or less
	Output operation	Open when the output is ON (data is determined).	
	Short circuit protection	Incorporated (Auto-reset)	

		HL-C2C(E)	HL-C2C(E)-P
Remote interlock input		Laser emission is delayed when connected to Common (-). Laser emission stop at open	Laser emission is delayed when connected to IL (+). Laser emission stop at open
Laser control input		Laser emission is stopped when connected to Common (-). Laser is emitted immediately after opened.	Laser emission is stopped when connected to external power (+). Laser is emitted immediately after opened. Applied voltage: 10.8 to 30VDC (Leak current: 0.1mA or less)
Zero set input		Zero set is ON when connected with Common (-). Zero set turns to OFF after continuously connected to Common (-) for one second.	Zero set is ON when connected with external power (+). Zero set turns to OFF after continuously connected to external power (+) for one second. Applied voltage: 10.8 to 30VDC (Leak current: 0.1mA or less)
Timing input		ON at/during connection to Common (-) (depending on analysis mode)	ON at/during connection to external power (+) (depending on analysis mode) Applied voltage: 10.8 to 30VDC (Leak current: 0.1mA or less)
Reset input		Reset is done when connected to Common (-).	Reset is done when connected to external power (+). Applied voltage: 10.8 to 30VDC (Leak current: 0.1mA or less)
Memory change input		Memory is specified when connected to Common (-).	Memory is specified when connected to external power (+). Applied voltage: 10.8 to 30VDC (Leak current: 0.1mA or less)
RS-232C interface		Baud rate: 9600, 19200, 38400, 115200bit/s	
USB interface		USB 2.0 Full-speed (USB 1.1 compatible) compliant	
Connecting sensor head		Maximum 2 sensor heads with connection compatibility	
Setting/data display		Compact programmable display	
Indicator	Power	Green LED: ON at power on.	
	Sensor head A Laser radiation	Green LED: ON during or immediately before laser emission of sensor head A.	
	Sensor head B Laser radiation	Green LED: ON during or immediately before laser emission of sensor head B.	
	Alarm 1	Red LED: ON when OUT1 can not be measured due to insufficient amount of light	
	Alarm 2	Red LED: ON when OUT2 can not be measured due to insufficient amount of light	
Protective structure		IP30	
Pollution Degree		2	
Insulation Resistance		20M ohms or more by 500V dc megger (between live parts and enclosure or F.G.)	
Dielectric Withstand	Commercial Frequency	AC500V for 1min. (between live parts and enclosure or F.G.)	
	Impulse	+/- 1000V 1.2/50 μ s (between power supply, input/output, and F.G.)	
Vibration resistance		Endurance: 10 to 55Hz (cycle: 1 minute), Resistant amplitude of vibration: 0.75mm, in X, Y, and Z directions for 30 minutes	
Shock resistance		196m/s ² in X, Y, and Z directions for 3 times	
Ambient temperature		0 to +50°C (No dew condensation or icing allowed) At storage: -20 to +70°C	

	HL-C2C(E)	HL-C2C(E)-P
Ambient humidity	35 to 85%RH	
Ambient Height	2000m or less	
Material	Case: polycarbonate	
Weight	Approx. 450g	
Applicable standards	Conformed to EMC Directive, Attained Korea's S-mark certification	

Measurement conditions are as follows unless otherwise specified; power voltage: 24VDC, ambient temperature: 20°C, sampling cycle: 40 μ s, average number of samples: 256 times, measurement center distance, and measurement object: white ceramic.

- *1 The linearity is F.S.=20V to digital measurement value. Response delay time is the period after update of measurement value.
- *2 The linearity is F.S.=16mA to digital measurement value. Response delay time is the period after update of measurement value.

● Ethernet type

Model No.		HL-C21C(E)	HL-C21C(E)-P
Supply voltage		24VDC \pm 10% Including ripple 0.5V (P-P)	
Current consumption		Approx. 500mA at 2 sensor heads connected Approx. 350mA at 1 sensor head connected (Approx. 100mA is additionally required when the compact programmable display is connected.)	
Sampling cycle		10 μ s, 20 μ s, 40 μ s, 100 μ s, 200 μ s, 400 μ s, 1ms, 2ms	
Analog output	Voltage ¹	Voltage output scale: -5 to +5V/F.S (initial value) Output range during normal status: -10.0 to +10.0V Output at abnormal status: -10.8V or +10.8V Resolution: 2mV, Linearity: \pm 0.05% F.S. Max. 2mA, output impedance 50 Ω , Response delay time: Approx. 1.5 μ s/V	
	Current ²	Current output scale: 4 to 20mA/F.S (initial value) Output range during normal status: 2 to 24mA Output at abnormal status: 1mA or 25mA Resolution: 3mA, Linearity \pm 0.05% F.S. Load impedance: 250 Ω max., Response delay time: Approx. 10 μ s	
Alarm output		NPN transistor open collector Maximum in-flow current: 100mA Applied voltage: 3 to 30VDC (ALARM output to Common(-)) Residual voltage: 1V or less (at in-flow current of 100mA) Leak current : 0.05mA or less	PNP transistor open collector Maximum out-flow current: 100mA Applied voltage: 3 to 30VDC (ALARM output to +V) Residual voltage: 1V or less (at out-flow current of 100mA) Leak current : 0.05mA or less
	Output operation	Open when the output is ON (Light intensity is insufficient).	
	Short circuit protection	Incorporated (Auto-reset)	
Judgment output (HI, GO, LO)		NPN transistor open collector Maximum in-flow current: 100mA Applied voltage: 3 to 30VDC (Judgment output to Common(-)) Residual voltage: 1V or less (at in-flow current of 100mA) Leak current : 0.05mA or less	PNP transistor open collector Maximum out-flow current: 100mA Applied voltage: 3 to 30VDC (Judgment output to +V) Residual voltage: 1V or less (at out-flow current of 100mA) Leak current : 0.05mA or less
	Output operation	Open when the output is ON(output operates).	
	Short circuit protection	Incorporated (Auto-reset)	
Strobe output		NPN transistor open collector Maximum in-flow current: 100mA Applied voltage: 3 to 30VDC (Strobe output to Common(-)) Residual voltage: 1V or less (at in-flow current of 100mA) Leak current : 0.05mA or less	PNP transistor open collector Maximum out-flow current: 100mA Applied voltage: 3 to 30VDC (Strobe output to +V) Residual voltage: 1V or less (at out-flow current of 100mA) Leak current : 0.05mA or less
	Output operation	Open when the output is ON(data is determined).	
	Short circuit protection	Incorporated (Auto-reset)	

		HL-C21C(E)	HL-C21C(E)-P
Remote interlock input		Laser emission is delayed when connected to Common (-). Laser emission stop at open	Laser emission is delayed when connected to IL (+). Laser emission stop at open
Laser control input		Laser emission is stopped when connected to Common (-). Laser is emitted immediately after opened.	Laser emission is stopped when connected to external power (+). Laser is emitted immediately after opened. Applied voltage: 10.8 to 30VDC (Leak current: 0.1mA or less)
Zero set input		Zero set is ON when connected with Common (-). Zero set turns to OFF after continuously connected to Common (-) for one second.	Zero set is ON when connected with external power (+). Zero set turns to OFF after continuously connected to external power (+) for one second. Applied voltage: 10.8 to 30VDC (Leak current: 0.1mA or less)
Timing input		ON at/during connection to Common (-) (depending on analysis mode)	ON at/during connection to external power (+) (depending on analysis mode) Applied voltage: 10.8 to 30VDC (Leak current: 0.1mA or less)
Reset input		Reset is done when connected to Common (-).	Reset is done when connected to external power (+). Applied voltage: 10.8 to 30VDC (Leak current: 0.1mA or less)
Memory change input		Memory is specified when connected to Common (-).	Memory is specified when connected to external power (+). Applied voltage: 10.8 to 30VDC (Leak current: 0.1mA or less)
Ethernet interface		IEEE 802.3u,100BASE-TX/10BASE-T Connector shape: RJ45	
USB interface		USB 2.0 Full-speed (USB 1.1 compatible) compliant	
Connecting sensor head		Maximum 2 sensor heads with connection compatibility	
Setting/data display		Compact programmable display	
Indicator	Power	Green LED: ON at power on.	
	Sensor head A Laser radiation	Green LED: ON during or immediately before laser emission of sensor head A.	
	Sensor head B Laser radiation	Green LED: ON during or immediately before laser emission of sensor head B.	
	Alarm 1	Red LED: ON when OUT1 can not be measured due to insufficient amount of light	
	Alarm 2	Red LED: ON when OUT2 can not be measured due to insufficient amount of light	
Protective structure		IP30	
Pollution Degree		2	
Insulation Resistance		20M ohms or more by 500V dc megger (between live parts and enclosure or F.G.)	
Dielectric Withstand	Commercial Frequency	AC500V for 1min. (between live parts and enclosure or F.G.)	
	Impulse	+/- 1000V 1.2/50 μ s (between power supply, input/output, and F.G.)	
Vibration resistance		Endurance: 10 to 55Hz (cycle: 1 minute), Resistant amplitude of vibration: 0.75mm, in X, Y, and Z directions for 30 minutes	
Shock resistance		196m/s ² in X, Y, and Z directions for 3 times	
Ambient temperature		0 to +50°C (No dew condensation or icing allowed) At storage: -20 to +70°C	

	HL-C21C(E)	HL-C21C(E)-P
Ambient humidity	35 to 85%RH	
Ambient Height	2000m or less	
Material	Case: polycarbonate	
Weight	Approx. 450g	
Applicable standards	Conformed to EMC Directive	

Measurement conditions are as follows unless otherwise specified; power voltage: 24VDC, ambient temperature: 20°C, sampling cycle: 40 μ s, average number of samples: 256 times, measurement center distance, and measurement object: white ceramic.

- *1 The linearity is F.S.=20V to digital measurement value. Response delay time is the period after update of measurement value.
- *2 The linearity is F.S.=16mA to digital measurement value. Response delay time is the period after update of measurement value.

8-2 Sensor Head Specifications

■ Sensor Head Model

The model of HL-C2 sensor head is indicated as shown below.

H L - C 2

Measurement center distance

01	8mm type
	10mm type
	15mm type
03	30mm type
05	50mm type
08	85mm type
11	110mm type
35	350mm type

Laser class or FDA

A	Class 1 (JIS/IEC)
B	Class 2 (JIS/IEC)
C	Class 3R (JIS/IEC)
F	FDA-compliant (Class I / II) *
F5	FDA-compliant (Class IIIa)

*: FDA is supported by HL-C205 / 208 / 235CE-W.

Export control

None	Pertinent
E	Non-pertinent (E type)

Spot

None	Spot type
-MK	Line spot type
-SP <input type="checkbox"/>	Spot type
-SP <input type="checkbox"/> M	Line spot type
-W	Wide range spot type
-WMK	Wide range line spot type

In “8-2 Sensor Head Specifications”, “8-5 Outside Dimension”, and “8-6 Characteristics”, the type of sensor head is classified by the kind of measurement center distance unless otherwise specified. The model name is therefore partially omitted.

■CHECK in specifications

Measuring conditions are as follows unless otherwise specified; connection with controller, power voltage: 24VDC, ambient temperature: 20°C, sampling cycle: 40 μ s, average number of samples: 256 times, measurement center distance, measurement object: white ceramic (10mm type is an aluminum vapor deposition surface reflection mirror), and digital measurement value.

■List of products which have attained the Korea's S-mark certification

Type	Model
10mm type	HL-C201A/HL-C201A-MK HL-C201AE/HL-C201AE-MK
30mm type	HL-C203B/HL-C203B-MK HL-C203BE/HL-C203BE-MK
110mm type(Class2)	HL-C211B/HL-C211B-MK HL-C211BE/HL-C211BE-MK
110mm type(Class3R)	HL-C211C/HL-C211C-MK HL-C211CE/HL-C211CE-MK
350mm type(Class2)	HL-C235BE/HL-C235BE-MK
350mm type(Class3R)	HL-C235CE/HL-C235CE-MK

● 10mm type

Model No.	HL-C201A, HL-C201F HL-C201AE, HL-C201FE	HL-C201A-MK, HL-C201F-MK HL-C201AE-MK, HL-C201FE-MK
Measurement method	Specular reflection	
Measurement center distance	10mm	
Measurement range ¹⁾	±1mm	
Beam source	Red semiconductor laser Class 1 (JIS/IEC/GB/KS) ²⁾ Max output: 0.1mW, Emission peak wavelength: 658nm	
Beam diameter ³⁾	Approx. φ20μm	Approx. 20×700μm
Beam receiving element	Linear image sensor	
Resolution	0.04μm/average times: 256, 0.01μm/average times: 4096 (E type ⁴⁾ 0.25μm/average times 256)	
Linearity	±0.02% F.S. (E type ⁴⁾ ±0.025% F.S.)	
Temperature characteristics	0.01% F.S./°C (E type ⁴⁾ 0.013% F.S./°C)	
Indicator	Laser emission	Green LED: ON during laser emission.
	Measurement range	Yellow LED: Near measurement center: ON/within measurement range : Blink/Beyond the range: OFF
Protective structure	IP67 (except connector)	
Pollution Degree	2	
Insulation Resistance	20M ohms or more by 500V dc megger (between all the terminals and enclosure.)	
Dielectric Withstand	Commercial Frequency	AC500V for 1min. (between all the terminals and enclosure.)
	Impulse	+/- 1000V 1.2/50 μs (between all the terminals and enclosure.)
Vibration resistance	Endurance: 10 to 55Hz (cycle: 1minute), Resistant amplitude of vibration: 1.5mm, in X, Y, and Z directions for 2 hours	
Shock resistance	196m/ s ² in X, Y, and Z directions for 3 times	
Ambient illuminance	3,000lx or less ⁵⁾ (illuminance at beam receiving surface using incandescent lamp)	
Ambient temperature	0 to +45°C (No dew condensation or icing allowed), At storage: -20 to +70°C	
Ambient humidity	35 to 85%RH At storage: 35 to 85%RH	
Ambient Height	2000m or less	
Material	Main unit case & cover: aluminum die-cast, Front cover: glass	
Cable length	0.5m	
Cable extension	Extendible to 30m long maximum using the optional extension cable.	
Weight	Approx. 250g including cable weight	
Accessory	Laser warning label: 1 set	
Applicable standards	Conformed to EMC Directive, Attained Korea's S-mark certification ⁶⁾	

For measuring conditions, refer to "8-2 Sensor Head Specifications" - "CHECK in specifications".

- *1 The measurement range is between +0.1 and +1.0mm (in case the sampling cycle is 20 μ s), or between +0.8 and +1.0mm (in case the sampling cycle is 10 μ s).
- *2 FDA-compliant model is classified into Class I Laser Notice No.50, based on FDA PART1040.
- *3 The figure shows the value at measurement center distance. It is determined by $1/e^2$ (approximately 13.5%) of center beam intensity. The reflectance around the detecting point may be higher than at the point due to leak light outside the specified area, and this may affect the measurement value.
- *4 The minimum resolution of 0.25 μ m, linearity of $\pm 0.025\%$ F.S. and temperature characteristics of 0.013%F.S./ $^{\circ}$ C can be achieved if the sensor head is connected to the controller that is not subject to "Foreign Exchange and Foreign Trade Law".
- *5 Variance is $\pm 0.02\%$ F.S. or less depending on the ambient illuminance.
- *6 For models compliant with standards, refer to "8-2 Sensor Head Specifications" - "List of models attained Korea's S-mark certification".

● 30mm type

Model No.	HL-C203B, HL-203F HL-C203BE, HL-C203FE		HL-C203B-MK, HL-203F-MK HL-C203BE-MK, HL-C203FE-MK	
	Diffuse Reflection	Specular Reflection	Diffuse Reflection	Specular Reflection
Measurement method ¹	Diffuse reflection/Specular reflection			
Measurement center distance	30mm	26.4mm	30mm	26.4mm
Measurement range ²	±5mm	±4.6mm	±5mm	±4.6mm
Beam source	Red semiconductor laser Class 2 (JIS/IEC/GB/KS) ³ Max output: 1mW, Emission peak wavelength: 658nm			
Beam diameter ⁴	Approx. φ30μm		Approx. 30 x 1200μm	
Beam receiving element	Linear image sensor			
Resolution	0.1μm/ average times: 256, 0.025μm/average times: 4096 (E type ⁵ 0.25μm/average times 256)			
Linearity	±0.03% F.S.			
Temperature characteristics	0.01% F.S./°C			
Indicator	Laser emission			
	Green LED: ON during laser emission.			
Measurement range	Yellow LED:			
	Near measurement center: ON/within measurement range : Blink/Beyond the range: OFF			
Protective structure	IP67 (except connector)			
Pollution Degree	2			
Insulation Resistance	20M ohms or more by 500V dc megger (between all the terminals and enclosure.)			
Dielectric Withstand	Commercial Frequency	AC500V for 1min. (between all the terminals and enclosure.)		
	Impulse	+/- 1000V 1.2/50 μs (between all the terminals and enclosure.)		
Vibration resistance	Endurance: 10 to 55Hz (cycle: 1 minute), Resistant amplitude of vibration: 1.5mm, in X, Y, and Z directions for 2 hours			
Shock resistance	196m/ s ² in X, Y, and Z directions for 3 times			
Ambient illuminance	3,000lx or less ⁶ (illuminance at beam receiving surface using incandescent lamp)			
Ambient temperature	0 to +45°C (No dew condensation or icing allowed), At storage: -20 to +70°C			
Ambient humidity	35 to 85%RH At storage: 35 to 85%RH			
Ambient Height	2000m or less			
Material	Main unit case & cover: aluminum die-cast, Front cover: glass			
Cable length	0.5m			
Cable extension	Extendible to 30m long maximum using the optional extension cable.			
Weight	Approx. 250g including cable weight			
Accessory	Laser warning label: 1 set			
Applicable standards	Conformed to EMC Directive, Attained Korea's S-mark certification ⁷			

For measuring conditions, refer to "8-2 Sensor Head Specifications" - "CHECK in specifications".

- *1 Use the external ND filter (optional) in case the amount of reflected beam is too large on Specular Reflection installation.
- *2 The measurement range is limited between 0 and +5.0mm (in case the sampling cycle is 20 μ s at diffuse reflection), between 0 and +4.6mm (in case the sampling cycle is 20 μ s at specular reflection), between +3.8 and +5.0mm (in case the sampling cycle is 10 μ s at diffuse reflection), or between +3.6 and +4.6mm(in case the sampling cycle is 10 μ s at specular reflection).
- *3 FDA-compliant model is classified into Class II, based on FDA PART1040.
- *4 The figure shows the value at measurement center distance. It is determined by $1/e^2$ (approximately 13.5%) of center beam intensity. The reflectance around the detecting point may be higher than at the point due to leak light outside the specified area, and this may affect the measurement value.
- *5 The minimum resolution is 0.25 μ m while the sensor head is connected to the controller that is not subject to "Foreign Exchange and Foreign Trade Law".
- *6 Variance is $\pm 0.03\%$ F.S. or less depending on the ambient illuminance.
- *7 For models compliant with standards, refer to "8-2 Sensor Head Specifications" - "List of models attained Korea's S-mark certification".

● 50mm type (Class2)

Model No.	HL-C205B, HL-C205BE		HL-C205B-MK, HL-C205BE-MK	
	Diffuse Reflection	Specular Reflection	Diffuse Reflection	Specular Reflection
Measurement method ¹	Diffuse reflection/Specular reflection			
Measurement center distance	50mm	46mm	50mm	46mm
Measurement range ²	±5mm			
Beam source	Red semiconductor laser Class 2 (JIS/IEC/GB/KS/FDA) Max output: 1mW, Emission peak wavelength: 658nm			
Beam diameter ³	Approx. ϕ 70 μ m		Approx. 70 x 1000 μ m	
Beam receiving element	Linear image sensor			
Resolution	0.2 μ m/ average times: 256, 0.05 μ m/average times: 4096 (E type ³ 0.25 μ m/average times 256)			
Linearity	±0.03% F.S.			
Temperature characteristics	0.01% F.S./°C			
Indicator	Laser emission	Green LED: ON during laser emission.		
	Measurement range	Yellow LED: Near measurement center: ON/within measurement range : Blink/Beyond the range: OFF		
Protective structure	IP67 (except connector)			
Pollution Degree	2			
Insulation Resistance	20M ohms or more by 500V dc megger (between all the terminals and enclosure.)			
Dielectric Withstand	Commercial Frequency	AC500V for 1min. (between all the terminals and enclosure.)		
	Impulse	+/- 1000V 1.2/50 μ s (between all the terminals and enclosure.)		
Vibration resistance	Endurance: 10 to 55Hz (cycle: 1 minute), Resistant amplitude of vibration: 1.5mm, in X, Y, and Z directions for 2 hours			
Shock resistance	196m/ s ² in X, Y, and Z directions for 3 times			
Ambient illuminance	3,000lx or less ⁵ (illuminance at beam receiving surface using incandescent lamp)			
Ambient temperature	0 to +45°C (No dew condensation or icing allowed), At storage: -20 to +70°C			
Ambient humidity	35 to 85%RH At storage: 35 to 85%RH			
Ambient Height	2000m or less			
Material	Main unit case & cover: aluminum die-cast, Front cover: glass			
Cable length	0.5m			
Cable extension	Extendible to 30m long maximum using the optional extension cable.			
Weight	Approx. 300g including cable weight			
Accessory	Laser warning label: 1 set			
Applicable standards	Conformed to EMC Directive			

For measuring conditions, refer to "8-2 Sensor Head Specifications" - "CHECK in specifications".

- *1 Use the external ND filter (optional) in case the amount of reflected beam is too large on Specular Reflection installation.
- *2 The measurement range is limited between +0.5 and +5.0mm (in case the sampling cycle is 20 μ s at diffuse reflection), between +0.5 and +5.0mm (in case the sampling cycle is 20 μ s at specular reflection), between +4.7 and +5.0mm (in case the sampling cycle is 10 μ s at diffuse reflection), or between +4.6 and +5.0mm(in case the sampling cycle is 10 μ s at specular reflection).
- *3 The figure shows the value at measurement center distance. It is determined by $1/e^2$ (approximately 13.5%) of center beam intensity. The reflectance around the detecting point may be higher than at the point due to leak light outside the specified area, and this may affect the measurement value.
- *4 The minimum resolution is 0.25 μ m while the sensor head is connected to the controller that is not subject to "Foreign Exchange and Foreign Trade Law".
- *5 Variance is $\pm 0.03\%$ F.S. or less depending on the ambient illuminance.

● 50mm type (Class3R)

Model No.	HL-C205C, HL-C205CE		HL-C205C-MK, HL-C205CE-MK	
	Diffuse Reflection	Specular Reflection	Diffuse Reflection	Specular Reflection
Measurement method ¹	Diffuse reflection/Specular reflection			
Measurement center distance	50mm	46mm	50mm	46mm
Measurement range ²	±5mm			
Beam source	Red semiconductor laser Class 3R (JIS/IEC/GB/KS/FDA) Max output: 5mW, Emission peak wavelength: 658nm			
Beam diameter ³	Approx. $\phi 70\mu\text{m}$		Approx. 70 x 1000 μm	
Beam receiving element	Linear image sensor			
Resolution	0.2 μm / average times: 256, 0.05 μm /average times: 4096 (E type ³ 0.25 μm /average times 256)			
Linearity	±0.03% F.S.			
Temperature characteristics	0.01% F.S./°C			
Indicator	Laser emission	Green LED: ON during laser emission.		
	Measurement range	Yellow LED: Near measurement center: ON/within measurement range : Blink/Beyond the range: OFF		
Protective structure	IP67 (except connector)			
Pollution Degree	2			
Insulation Resistance	20M ohms or more by 500V dc megger (between all the terminals and enclosure.)			
Dielectric Withstand	Commercial Frequency	AC500V for 1min. (between all the terminals and enclosure.)		
	Impulse	+/- 1000V 1.2/50 μs (between all the terminals and enclosure.)		
Vibration resistance	Endurance: 10 to 55Hz (cycle: 1 minute), Resistant amplitude of vibration: 1.5mm, in X, Y, and Z directions for 2 hours			
Shock resistance	196m/ s ² in X, Y, and Z directions for 3 times			
Ambient illuminance	3,000lx or less ⁵ (illuminance at beam receiving surface using incandescent lamp)			
Ambient temperature	0 to +45°C (No dew condensation or icing allowed), At storage: -20 to +70°C			
Ambient humidity	35 to 85%RH At storage: 35 to 85%RH			
Ambient Height	2000m or less			
Material	Main unit case & cover: aluminum die-cast, Front cover: glass			
Cable length	0.5m			
Cable extension	Extendible to 30m long maximum using the optional extension cable.			
Weight	Approx. 300g including cable weight			
Accessory	Laser warning label: 1 set			
Applicable standards	Conformed to EMC Directive			

- For measuring conditions, refer to "8-2 Sensor Head Specifications" - "CHECK in specifications"..
- *1 Use the external ND filter (optional) in case the amount of reflected beam is too large on Specular Reflection installation.
 - *2 The measurement range is limited between +0.5 and +5.0mm (in case the sampling cycle is 20 μ s at diffuse reflection), between +0.5 and +5.0mm (in case the sampling cycle is 20 μ s at specular reflection), between +4.7 and +5.0mm (in case the sampling cycle is 10 μ s at diffuse reflection), or between +4.6 and +5.0mm(in case the sampling cycle is 10 μ s at specular reflection).
 - *3 The figure shows the value at measurement center distance. It is determined by $1/e^2$ (approximately 13.5%) of center beam intensity. The reflectance around the detecting point may be higher than at the point due to leak light outside the specified area, and this may affect the measurement value.
 - *4 The minimum resolution is 0.25 μ m while the sensor head is connected to the controller that is not subject to "Foreign Exchange and Foreign Trade Law".
 - *5 Variance is $\pm 0.03\%$ F.S. or less depending on the ambient illuminance.

● 85mm type (Class2)

Model No.	HL-C208B, HL-C208BE		HL-C208B-MK, HL-C208BE-MK	
	Diffuse Reflection	Specular Reflection	Diffuse Reflection	Specular Reflection
Measurement method ¹	Diffuse reflection/Specular reflection			
Measurement center distance	85mm	81.4mm	85mm	81.4mm
Measurement range ²	±20mm	±6mm	±20mm	±6mm
Beam source	Red semiconductor laser Class 2 (JIS/IEC/GB/KS/FDA) Max output: 1mW, Emission peak wavelength: 658nm			
Beam diameter ³	Approx. φ100μm		Approx. 100 x 1200μm	
Beam receiving element	Linear image sensor			
Resolution	0.6μm/ average times: 256, 0.15μm/average times: 4096 (E type 0.6μm/average times 256, 0.25μm ⁴ /average times 4096)			
Linearity	±0.03% F.S.	±0.1% F.S.	±0.03% F.S.	±0.1% F.S.
Temperature characteristics	0.01% F.S./°C			
Indicator	Laser emission			
	Green LED: ON during laser emission.			
Measurement range	Yellow LED:			
	Near measurement center: ON/within measurement range : Blink/Beyond the range: OFF			
Protective structure	IP67 (except connector)			
Pollution Degree	2			
Insulation Resistance	20M ohms or more by 500V dc megger (between all the terminals and enclosure.)			
Dielectric Withstand	Commercial Frequency	AC500V for 1min. (between all the terminals and enclosure.)		
	Impulse	+/- 1000V 1.2/50 μs (between all the terminals and enclosure.)		
Vibration resistance	Endurance: 10 to 55Hz (cycle: 1 minute), Resistant amplitude of vibration: 1.5mm, in X, Y, and Z directions for 2 hours			
Shock resistance	196m/ s ² in X, Y, and Z directions for 3 times			
Ambient illuminance	3,000lx or less ⁵ (illuminance at beam receiving surface using incandescent lamp)			
Ambient temperature	0 to +45°C (No dew condensation or icing allowed), At storage: -20 to +70°C			
Ambient humidity	35 to 85%RH At storage: 35 to 85%RH			
Ambient Height	2000m or less			
Material	Main unit case & cover: aluminum die-cast, Front cover: glass			
Cable length	0.5m			
Cable extension	Extendible to 30m long maximum using the optional extension cable.			
Weight	Approx. 300g including cable weight			
Accessory	Laser warning label: 1 set			
Applicable standards	Conformed to EMC Directive			

For measuring conditions, refer to "8-2 Sensor Head Specifications" - "CHECK in specifications".

- *1 Use the external ND filter (optional) in case the amount of reflected beam is too large on Specular Reflection installation.
- *2 The measurement range is limited between 0 and +20mm (in case the sampling cycle is 20 μ s at diffuse reflection), between 0 and +6mm (in case the sampling cycle is 20 μ s at specular reflection), between +18 and +20mm (in case the sampling cycle is 10 μ s at diffuse reflection), or unmeasurable (in case the sampling cycle is 10 μ s at specular reflection).
- *3 The figure shows the value at measurement center distance. It is determined by $1/e^2$ (approximately 13.5%) of center beam intensity. The reflectance around the detecting point may be higher than at the point due to leak light outside the specified area, and this may affect the measurement value.
- *4 The minimum resolution is 0.25 μ m while the sensor head is connected to the controller that is not subject to "Foreign Exchange and Foreign Trade Law".
- *5 Variance is $\pm 0.03\%$ F.S. or less depending on the ambient illuminance.

● 85mm type (Class3R)

Model No.	HL-C208C, HL-C208CE		HL-C208C-MK, HL-C208CE-MK	
	Diffuse Reflection	Specular Reflection	Diffuse Reflection	Specular Reflection
Measurement method ¹	Diffuse reflection/Specular reflection			
Measurement center distance	85mm	81.4mm	85mm	81.4mm
Measurement range ²	±20mm	±6mm	±20mm	±6mm
Beam source	Red semiconductor laser Class 3R (JIS/IEC/GB/KS/FDA) Max output: 5mW, Emission peak wavelength: 658nm			
Beam diameter ³	Approx. φ100μm		Approx. 100 x 1200μm	
Beam receiving element	Linear image sensor			
Resolution	0.6μm/ average times: 256, 0.15μm/average times: 4096 (E type 0.6μm/average times 256, 0.25μm ⁴ /average times 4096)			
Linearity	±0.03% F.S.	±0.1% F.S.	±0.03% F.S.	±0.1% F.S.
Temperature characteristics	0.01% F.S./°C			
Indicator	Laser emission	Green LED: ON during laser emission.		
	Measurement range	Yellow LED: Near measurement center: ON/within measurement range : Blink/Beyond the range: OFF		
Protective structure	IP67 (except connector)			
Pollution Degree	2			
Insulation Resistance	20M ohms or more by 500V dc megger (between all the terminals and enclosure.)			
Dielectric Withstand	Commercial Frequency	AC500V for 1min. (between all the terminals and enclosure.)		
	Impulse	+/- 1000V 1.2/50 μs (between all the terminals and enclosure.)		
Vibration resistance	Endurance: 10 to 55Hz (cycle: 1 minute), Resistant amplitude of vibration: 1.5mm, in X, Y, and Z directions for 2 hours			
Shock resistance	196m/ s ² in X, Y, and Z directions for 3 times			
Ambient illuminance	3,000lx or less ⁵ (illuminance at beam receiving surface using incandescent lamp)			
Ambient temperature	0 to +45°C (No dew condensation or icing allowed), At storage: -20 to +70°C			
Ambient humidity	35 to 85%RH At storage: 35 to 85%RH			
Ambient Height	2000m or less			
Material	Main unit case & cover: aluminum die-cast, Front cover: glass			
Cable length	0.5m			
Cable extension	Extendible to 30m long maximum using the optional extension cable.			
Weight	Approx. 300g including cable weight			
Accessory	Laser warning label: 1 set			
Applicable standards	Conformed to EMC Directive			

For measuring conditions, refer to "8-2 Sensor Head Specifications" - "CHECK in specifications"..

- *1 Use the external ND filter (optional) in case the amount of reflected beam is too large on Specular Reflection installation.
- *2 The measurement range is limited between 0 and +20mm (in case the sampling cycle is 20 μ s at diffuse reflection), between 0 and +6mm (in case the sampling cycle is 20 μ s at specular reflection), between +18 and +20mm (in case the sampling cycle is 10 μ s at diffuse reflection), or unmeasurable (in case the sampling cycle is 10 μ s at specular reflection).
- *3 The figure shows the value at measurement center distance. It is determined by $1/e^2$ (approximately 13.5%) of center beam intensity. The reflectance around the detecting point may be higher than at the point due to leak light outside the specified area, and this may affect the measurement value.
- *4 The minimum resolution is 0.25 μ m while the sensor head is connected to the controller that is not subject to "Foreign Exchange and Foreign Trade Law".
- *5 Variance is $\pm 0.03\%$ F.S. or less depending on the ambient illuminance.

● 110mm type (Class2³)

Model No.	HL-C211B, HL-211F HL-C211BE, HL-C211FE		HL-C211B-MK, HL-211F-MK HL-C211BE-MK, HL-C211FE-MK	
	Diffuse Reflection	Specular Reflection	Diffuse Reflection	Specular Reflection
Measurement method ¹	Diffuse reflection/Specular reflection			
Measurement center distance	110mm	106.7mm	110mm	106.7mm
Measurement range ²	±15mm	±14.5mm	±15mm	±14.5mm
Beam source	Red semiconductor laser Class 2 (JIS/IEC/GB/KS) ³ Max output: 1mW, Emission peak wavelength: 658nm			
Beam diameter ⁴	Approx. φ80μm		Approx. 80 x 1700μm	
Beam receiving element	Linear image sensor			
Resolution	0.4μm/ average times: 256, 0.1μm/average times: 4096 (E type ⁵ 0.25μm/average times 4096)			
Linearity	±0.03% F.S.			
Temperature characteristics	0.01% F.S./°C			
Indicator	Laser emission	Green LED: ON during laser emission.		
	Measurement range	Yellow LED: Near measurement center: ON/within measurement range : Blink/Beyond the range: OFF		
Protective structure	IP67 (except connector)			
Pollution Degree	2			
Insulation Resistance	20M ohms or more by 500V dc megger (between all the terminals and enclosure.)			
Dielectric Withstand	Commercial Frequency	AC500V for 1min. (between all the terminals and enclosure.)		
	Impulse	+/- 1000V 1.2/50 μs (between all the terminals and enclosure.)		
Vibration resistance	Endurance: 10 to 55Hz (cycle: 1 minute), Resistant amplitude of vibration: 1.5mm, in X, Y, and Z directions for 2 hours			
Shock resistance	196m/ s ² in X, Y, and Z directions for 3 times			
Ambient illuminance	3,000lx or less ⁶ (illuminance at beam receiving surface using incandescent lamp)			
Ambient temperature	0 to +45°C (No dew condensation or icing allowed), At storage: -20 to +70°C			
Ambient humidity	35 to 85%RH At storage: 35 to 85%RH			
Ambient Height	2000m or less			
Material	Main unit case & cover: aluminum die-cast, Front cover: glass			
Cable length	0.5m			
Cable extension	Extendible to 30m long maximum using the optional extension cable.			
Weight	Approx. 300g including cable weight			
Accessory	Laser warning label: 1 set			
Applicable standards	Conformed to EMC Directive, Attained Korea's S-mark certification ⁷			

For measuring conditions, refer to "8-2 Sensor Head Specifications" - "CHECK in specifications".

- *1 Use the external ND filter (optional) in case the amount of reflected beam is too large on Specular Reflection installation.
- *2 The measurement range is limited between +0.5 and +15.0mm (in case the sampling cycle is 20 μ s at diffuse reflection), between +0.5 and +14.5mm (in case the sampling cycle is 20 μ s at specular reflection), between +12.5 and +15.0mm (in case the sampling cycle is 10 μ s at diffuse reflection), or between +12.5 and +14.5mm(in case the sampling cycle is 10 μ s at specular reflection).
- *3 FDA-compliant model is classified into Class II, based on FDA PART1040.
- *4 The figure shows the value at measurement center distance. It is determined by $1/e^2$ (approximately 13.5%) of center beam intensity. The reflectance around the detecting point may be higher than at the point due to leak light outside the specified area, and this may affect the measurement value.
- *5 The minimum resolution is 0.25 μ m while the sensor head is connected to the controller that is not subject to "Foreign Exchange and Foreign Trade Law".
- *6 Variance is $\pm 0.03\%$ F.S. or less depending on the ambient illuminance.
- *7 For models compliant with standards, refer to "8-2 Sensor Head Specifications" - "List of models attained Korea's S-mark certification".

● 110mm type (Class3R³)

Model No.	HL-C211C, HL-211F5 HL-C211CE, HL-C211F5E		HL-C211C-MK, HL-211F5-MK HL-C211CE-MK, HL-C211F5E-MK	
	Diffuse Reflection	Specular Reflection	Diffuse Reflection	Specular Reflection
Measurement method ¹	Diffuse reflection/Specular reflection			
Measurement center distance	110mm	106.7mm	110mm	106.7mm
Measurement range ²	±15mm	±14.5mm	±15mm	±14.5mm
Beam source	Red semiconductor laser Class 3R (JIS/IEC/GB/KS) ³ Max output: 5mW, Emission peak wavelength: 658nm			
Beam diameter ⁴	Approx. φ80μm		Approx. 80 x 1700μm	
Beam receiving element	Linear image sensor			
Resolution	0.4μm/ average times: 256, 0.1μm/average times: 4096 (E type ⁵ 0.25μm/average times 4096)			
Linearity	±0.03% F.S.			
Temperature characteristics	0.01% F.S./°C			
Indicator	Laser emission	Green LED: ON during laser emission.		
	Measurement range	Yellow LED: Near measurement center: ON/within measurement range : Blink/Beyond the range: OFF		
Protective structure	IP67 (except connector)			
Pollution Degree	2			
Insulation Resistance	20M ohms or more by 500V dc megger (between all the terminals and enclosure.)			
Dielectric Withstand	Commercial Frequency	AC500V for 1min. (between all the terminals and enclosure.)		
	Impulse	+/- 1000V 1.2/50 μs (between all the terminals and enclosure.)		
Vibration resistance	Endurance: 10 to 55Hz (cycle: 1 minute), Resistant amplitude of vibration: 1.5mm, in X, Y, and Z directions for 2 hours			
Shock resistance	196m/ s ² in X, Y, and Z directions for 3 times			
Ambient illuminance	3,000lx or less ⁶ (illuminance at beam receiving surface using incandescent lamp)			
Ambient temperature	0 to +45°C (No dew condensation or icing allowed), At storage: -20 to +70°C			
Ambient humidity	35 to 85%RH At storage: 35 to 85%RH			
Ambient Height	2000m or less			
Material	Main unit case & cover: aluminum die-cast, Front cover: glass			
Cable length	0.5m			
Cable extension	Extendible to 30m long maximum using the optional extension cable.			
Weight	Approx. 300g including cable weight			
Accessory	Laser warning label: 1 set			
Applicable standards	Conformed to EMC Directive, Attained Korea's S-mark certification ⁷			

- For measuring conditions, refer to "8-2 Sensor Head Specifications" - "CHECK in specifications"..
- *1 Use the external ND filter (optional) in case the amount of reflected beam is too large on Specular Reflection installation.
 - *2 The measurement range is limited between +0.5 and +15.0mm (in case the sampling cycle is 20 μ s at diffuse reflection), between +0.5 and +14.5mm (in case the sampling cycle is 20 μ s at specular reflection), between +12.5 and +15.0mm (in case the sampling cycle is 10 μ s at diffuse reflection), or between +12.5 and +14.5mm(in case the sampling cycle is 10 μ s at specular reflection).
 - *3 FDA-compliant model is classified into Class IIIa, based on FDA PART1040.
 - *4 The figure shows the value at measurement center distance. It is determined by $1/e^2$ (approximately 13.5%) of center beam intensity. The reflectance around the detecting point may be higher than at the point due to leak light outside the specified area, and this may affect the measurement value.
 - *5 The minimum resolution is 0.25 μ m while the sensor head is connected to the controller that is not subject to "Foreign Exchange and Foreign Trade Law".
 - *6 Variance is $\pm 0.03\%$ F.S. or less depending on the ambient illuminance.
 - *7 For models compliant with standards, refer to "8-2 Sensor Head Specifications" - "List of models attained Korea's S-mark certification".

● 350mm type (Class2)

Model No.		HL-C235BE		HL-C235BE-MK	
		Diffuse Reflection	Specular Reflection	Diffuse Reflection	Specular Reflection
Measurement method ¹		Diffuse reflection/Specular reflection			
Measurement center distance		350mm	348mm	350mm	348mm
Measurement range ²		±50mm	±42mm	±50mm	±42mm
Beam source		Red semiconductor laser Class 2 (JIS/IEC/GB/KS) Max output: 1mW, Emission peak wavelength: 658nm			
Beam diameter ³		Approx. φ250μm		Approx. 250 x 3500μm	
Beam receiving element		Linear image sensor			
Resolution		2.0μm/ average times: 256, 0.5μm/average times: 4096			
Linearity		±0.03% F.S.			
Temperature characteristics		0.01% F.S./°C			
Indicator	Laser emission	Green LED: ON during laser emission.			
	Measurement range	Yellow LED: Near measurement center: ON/within measurement range : Blink/Beyond the range: OFF			
Protective structure		IP67 (except connector)			
Pollution Degree		2			
Insulation Resistance		20M ohms or more by 500V dc megger (between all the terminals and enclosure.)			
Dielectric Withstand	Commercial Frequency	AC500V for 1min. (between all the terminals and enclosure.)			
	Impulse	+/- 1000V 1.2/50 μs (between all the terminals and enclosure.)			
Vibration resistance		Endurance: 10 to 55Hz (cycle: 1 minute), Resistant amplitude of vibration: 1.5mm, in X, Y, and Z directions for 2 hours			
Shock resistance		196m/ s ² in X, Y, and Z directions for 3 times			
Ambient illuminance		3,000lx or less ⁴ (illuminance at beam receiving surface using incandescent lamp)			
Ambient temperature		0 to +45°C (No dew condensation or icing allowed), At storage: -20 to +70°C			
Ambient humidity		35 to 85%RH At storage: 35 to 85%RH			
Ambient Height		2000m or less			
Material		Main unit case & cover: aluminum die-cast, Front cover: glass			
Cable length		0.5m			
Cable extension		Extendible to 30m long maximum using the optional extension cable.			
Weight		Approx. 450g including cable weight			
Suited controller ^{*5}		Controller ver.2.00 or later			
Accessory		Laser warning label: 1 set			
Applicable standards		Conformed to EMC Directive, Attained Korea's S-mark certification			

For measuring conditions, refer to "8-2 Sensor Head Specifications" - "CHECK in specifications".

- *1 Use the external ND filter (optional) in case the amount of reflected beam is too large on Specular Reflection installation.
- *2 The measurement range is limited between +0.0 and +50.0mm (in case the sampling cycle is 20 μ s at diffuse reflection), between +0.0 and +42mm (in case the sampling cycle is 20 μ s at specular reflection), between +36 and +50mm (in case the sampling cycle is 10 μ s at diffuse reflection), or between +36 and +42mm (in case the sampling cycle is 10 μ s at specular reflection).
- *3 The figure shows the value at measurement center distance. It is determined by $1/e^2$ (approximately 13.5%) of center beam intensity. The reflectance around the detecting point may be higher than at the point due to leak light outside the specified area, and this may affect the measurement value.
- *4 Variance is $\pm 0.03\%$ F.S. or less depending on the ambient illuminance.
- *5 It does not work properly in case connected to the controller ver.1**.

● 350mm type (Class3R)

Model No.	HL-C235CE		HL-C235CE-MK	
	Diffuse Reflection	Specular Reflection	Diffuse Reflection	Specular Reflection
Measurement method ¹	Diffuse reflection/Specular reflection			
Measurement center distance	350mm	348mm	350mm	348mm
Measurement range ²	±50mm	±42mm	±50mm	±42mm
Beam source	Red semiconductor laser Class 3R (JIS/IEC/GB/KS) Max output: 5mW, Emission peak wavelength: 658nm			
Beam diameter ³	Approx. φ250μm		Approx. 250 x 3500μm	
Beam receiving element	Linear image sensor			
Resolution	2.0μm/ average times: 256, 0.5μm/average times: 4096			
Linearity	±0.03% F.S.			
Temperature characteristics	0.01% F.S./°C			
Indicator	Laser emission	Green LED: ON during laser emission.		
	Measurement range	Yellow LED: Near measurement center: ON/within measurement range : Blink/Beyond the range: OFF		
Protective structure	IP67 (except connector)			
Pollution Degree	2			
Insulation Resistance	20M ohms or more by 500V dc megger (between all the terminals and enclosure.)			
Dielectric Withstand	Commercial Frequency	AC500V for 1min. (between all the terminals and enclosure.)		
	Impulse	+/- 1000V 1.2/50 μs (between all the terminals and enclosure.)		
Vibration resistance	Endurance: 10 to 55Hz (cycle: 1 minute), Resistant amplitude of vibration: 1.5mm, in X, Y, and Z directions for 2 hours			
Shock resistance	196m/ s ² in X, Y, and Z directions for 3 times			
Ambient illuminance	3,000lx or less*4 (illuminance at beam receiving surface using incandescent lamp)			
Ambient temperature	0 to +45°C (No dew condensation or icing allowed), At storage: -20 to +70°C			
Ambient humidity	35 to 85%RH At storage: 35 to 85%RH			
Ambient Height	2000m or less			
Material	Main unit case & cover: aluminum die-cast, Front cover: glass			
Cable length	0.5m			
Cable extension	Extendible to 30m long maximum using the optional extension cable.			
Weight	Approx. 450g including cable weight			
Suited controller *5	Controller ver.2.00 or later			
Accessory	Laser warning label: 1 set			
Applicable standards	Conformed to EMC Directive, Attained Korea's S-mark certification			

For measuring conditions, refer to "8-2 Sensor Head Specifications" - "CHECK in specifications".

- *1 Use the external ND filter (optional) in case the amount of reflected beam is too large on Specular Reflection installation.
- *2 The measurement range is limited between +0.0 and +50mm (in case the sampling cycle is 20 μ s at diffuse reflection), between +0.0 and +42mm (in case the sampling cycle is 20 μ s at specular reflection), between +36 and +50mm (in case the sampling cycle is 10 μ s at diffuse reflection), or between +36 and +42mm (in case the sampling cycle is 10 μ s at specular reflection).
- *3 The figure shows the value at measurement center distance. It is determined by $1/e^2$ (approximately 13.5%) of center beam intensity. The reflectance around the detecting point may be higher than at the point due to leak light outside the specified area, and this may affect the measurement value.
- *4 Variance is $\pm 0.03\%$ F.S. or less depending on the ambient illuminance.
- *5 It does not work properly in case connected to the controller ver.1**.

● 350mm type (Class3R)

Model No.		HL-C235CE-W	HL-C235CE-WMK
Measurement method ¹		Diffuse reflection	
Measurement center distance		350mm	350mm
Measurement range ²		±200mm	±200mm
Beam source		Red semiconductor laser Class 3R (JIS/IEC/GB/KS/FDA) Max output: 5mW, Emission peak wavelength: 658nm	
Beam diameter ³		Approx. φ400μm	Approx. 400 x 6500μm
Beam receiving element		Linear image sensor	
Resolution		8μm/ average times: 256, 2μm/average times: 4096	
Linearity		±0.04%F.S. (-200 to 0mm), ±0.08%F.S. (0 to +200mm) (F.S. = ±200mm)	
Temperature characteristics		0.01% F.S./°C	
Indicator	Laser emission	Green LED: ON during laser emission.	
	Measurement range	Yellow LED: Near measurement center: ON/within measurement range : Blink/Beyond the range: OFF	
Protective structure		IP67 (except connector)	
Pollution Degree		2	
Insulation Resistance		20M ohms or more by 500V dc megger (between all the terminals and enclosure.)	
Dielectric Withstand	Commercial Frequency	AC500V for 1min. (between all the terminals and enclosure.)	
	Impulse	+/- 1000V 1.2/50 μs (between all the terminals and enclosure.)	
Vibration resistance		Endurance: 10 to 55Hz (cycle: 1 minute), Resistant amplitude of vibration: 1.5mm, in X, Y, and Z directions for 2 hours	
Shock resistance		196m/ s ² in X, Y, and Z directions for 3 times	
Ambient illuminance		3,000lx or less*4 (illuminance at beam receiving surface using incandescent lamp)	
Ambient temperature		0 to +45°C (No dew condensation or icing allowed), At storage: -20 to +70°C	
Ambient humidity		35 to 85%RH At storage: 35 to 85%RH	
Ambient Height		2000m or less	
Material		Main unit case & cover: aluminum die-cast, Front cover: glass	
Cable length		0.5m	
Cable extension		Extendible to 30m long maximum using the optional extension cable.	
Weight		Approx. 300g including cable weight	
Accessory		Laser warning label: 1 set	
Applicable standards		Conformed to EMC Directive	

For measuring conditions, refer to "8-2 Sensor Head Specifications" - "CHECK in specifications".

- *1 Use the external ND filter (optional) in case the amount of reflected beam is too large on Specular Reflection installation.
- *2 The measurement range is limited between -70 and +200mm (in case the sampling cycle is 20 μ s), or between +100 and +200mm (in case the sampling cycle is 10 μ s).
- *3 The figure shows the value at measurement center distance. It is determined by $1/e^2$ (approximately 13.5%) of center beam intensity. The reflectance around the detecting point may be higher than at the point due to leak light outside the specified area, and this may affect the measurement value.
- *4 Variance is $\pm 0.08\%$ F.S. or less depending on the ambient illuminance.

● 8mm type (Class1)

Model No.		HL-C201A(E)-SP2	HL-C201A(E)-SP2M
Measurement method		Specular reflection	
Measurement center distance		8mm	
Measurement range ¹		±0.8mm	
Beam source		Red semiconductor laser Class 1 (JIS/IEC/GB/KS) Max output: 0.1mW, Emission peak wavelength: 658nm	
Beam diameter ²		Approx. φ20μm	Approx. 20 x 700μm
Beam receiving element		Linear image sensor	
Resolution		0.04μm/ average times: 256, 0.01μm/average times: 4096 [E type ⁽³⁾ : 0.25μm/ average times: 256]	
Linearity		±0.02% F.S. [E type ⁽⁴⁾ : ±0.032% F.S.]	
Temperature characteristics		0.02% F.S./°C	
Indicator	Laser emission	Green LED: ON during laser emission.	
	Measurement range	Yellow LED: Near measurement center: ON/within measurement range : Blink/Beyond the range: OFF	
Protective structure		IP67 (except connector)	
Pollution Degree		2	
Insulation Resistance		20M ohms or more by 500V dc megger (between all the terminals and enclosure.)	
Dielectric Withstand	Commercial Frequency	AC500V for 1min. (between all the terminals and enclosure.)	
	Impulse	+/- 1000V 1.2/50 μs (between all the terminals and enclosure.)	
Vibration resistance		Endurance: 10 to 55Hz (cycle: 1 minute), Resistant amplitude of vibration: 1.5mm, in X, Y, and Z directions for 2 hours	
Shock resistance		196m/ s ² in X, Y, and Z directions for 3 times	
Ambient illuminance		3,000lx or less ⁽⁵⁾ (illuminance at beam receiving surface using incandescent lamp)	
Ambient temperature		0 to +45°C (No dew condensation or icing allowed), At storage: -20 to +70°C	
Ambient humidity		35 to 85%RH At storage: 35 to 85%RH	
Ambient Height		2000m or less	
Material		Main unit case & cover: aluminum, Front cover: glass	
Cable length		0.08m	
Cable extension		Extendible to 30m long maximum using the optional extension cable.	
Weight		Approx. 300g including cable weight	
Accessory		Laser warning label: 1 set	
Applicable standards		Conformed to EMC Directive	

For measuring conditions, refer to "8-2 Sensor Head Specifications" - "CHECK in specifications".

- *1 The measurement range is between +0.1 and +0.8mm (in case the sampling cycle is 20 μ s), or between +0.7 and +0.8mm (in case the sampling cycle is 10 μ s).
- *2 The figure shows the value at measurement center distance. It is determined by $1/e^2$ (approximately 13.5%) of center beam intensity. The reflectance around the detecting point may be higher than at the point due to leak light outside the specified area, and this may affect the measurement value.
- *3 The minimum resolution of 0.25 μ m can be achieved if the sensor head is connected to the controller that is not subject to "Foreign Exchange and Foreign Trade Law".
- *4 The linearity of $\pm 0.032\%$ F.S. can be achieved if the sensor head is connected to the controller that is not subject to "Foreign Exchange and Foreign Trade Law".
- *5 Variance is $\pm 0.02\%$ F.S. or less depending on the ambient illuminance.

● 15mm type (Class1)

Model No.	HL-C201A(E)-SP3	HL-C201A(E)-SP3M
Measurement method	Specular reflection	
Measurement center distance	15mm	
Measurement range ¹	±1mm	
Beam source	Red semiconductor laser Class 1 (JIS/IEC/GB/KS) Max output: 0.3mW, Emission peak wavelength: 658nm	
Beam diameter ²	Approx. φ30μm	Approx. 30 x 1400μm
Beam receiving element	Linear image sensor	
Resolution	0.04μm/ average times: 256, 0.01μm/average times: 4096 [E type ^{(*)3}): 0.25μm/ average times: 256]	
Linearity	±0.02% F.S. [E type ^{(*)4}): ±0.025% F.S.]	
Temperature characteristics	0.02% F.S./°C	
Indicator	Laser emission	Green LED: ON during laser emission.
	Measurement range	Yellow LED: Near measurement center: ON/within measurement range : Blink/Beyond the range: OFF
Protective structure	IP67 (except connector)	
Pollution Degree	2	
Insulation Resistance	20M ohms or more by 500V dc megger (between all the terminals and enclosure.)	
Dielectric Withstand	Commercial Frequency	AC500V for 1min. (between all the terminals and enclosure.)
	Impulse	+/- 1000V 1.2/50 μs (between all the terminals and enclosure.)
Vibration resistance	Endurance: 10 to 55Hz (cycle: 1 minute), Resistant amplitude of vibration: 1.5mm, in X, Y, and Z directions for 2 hours	
Shock resistance	196m/ s ² in X, Y, and Z directions for 3 times	
Ambient illuminance	3,000lx or less ^{(*)5} (illuminance at beam receiving surface using incandescent lamp)	
Ambient temperature	0 to +45°C (No dew condensation or icing allowed), At storage: -20 to +70°C	
Ambient humidity	35 to 85%RH At storage: 35 to 85%RH	
Ambient Height	2000m or less	
Material	Main unit case & cover: aluminum, Front cover: glass	
Cable length	0.5m	
Cable extension	Extendible to 30m long maximum using the optional extension cable.	
Weight	Approx. 400g including cable weight	
Accessory	Laser warning label: 1 set	
Applicable standards	Conformed to EMC Directive	

For measuring conditions, refer to "8-2 Sensor Head Specifications" - "CHECK in specifications".

- *1 The measurement range is between +0.1 and +1.0mm (in case the sampling cycle is 20 μ s), or between +0.8 and +1.0mm (in case the sampling cycle is 10 μ s).
- *2 The figure shows the value at measurement center distance. It is determined by $1/e^2$ (approximately 13.5%) of center beam intensity. The reflectance around the detecting point may be higher than at the point due to leak light outside the specified area, and this may affect the measurement value.
- *3 The minimum resolution of 0.25 μ m can be achieved if the sensor head is connected to the controller that is not subject to "Foreign Exchange and Foreign Trade Law".
- *4 The linearity of $\pm 0.025\%$ F.S. can be achieved if the sensor head is connected to the controller that is not subject to "Foreign Exchange and Foreign Trade Law".
- *5 Variance is $\pm 0.02\%$ F.S. or less depending on the ambient illuminance.

8-3 ND Filter Specifications

Model No.	HL-C2F01
Applicable head	HL-C203□/HL-C203□-MK HL-C205□/HL-C205□-MK HL-C208□/HL-C208□-MK HL-C211□/HL-C211□-MK HL-C235□E/HL-C235□E-MK
Fading rate	98% *1
Shock resistance	196m/s ² or more in X, Y, and Z directions for 3 times
Ambient temperature	0 to +45°C (No dew condensation or icing allowed), At storage: -20 to +70°C
Ambient humidity	35 to 85%RH At Storage: 35 to 85%RH
Material	Retentive portion: aluminum, ND area: glass
Weight	Approx. 20g
Accessory	Mounting screw:2

*1 Mount the ND filter and use it if reflected light intensity from the measurement object is large.

8-4 Outside Dimension

■ Controller

- RS-232C type [HL-C2C(E)/HL-C2C(E)-P]

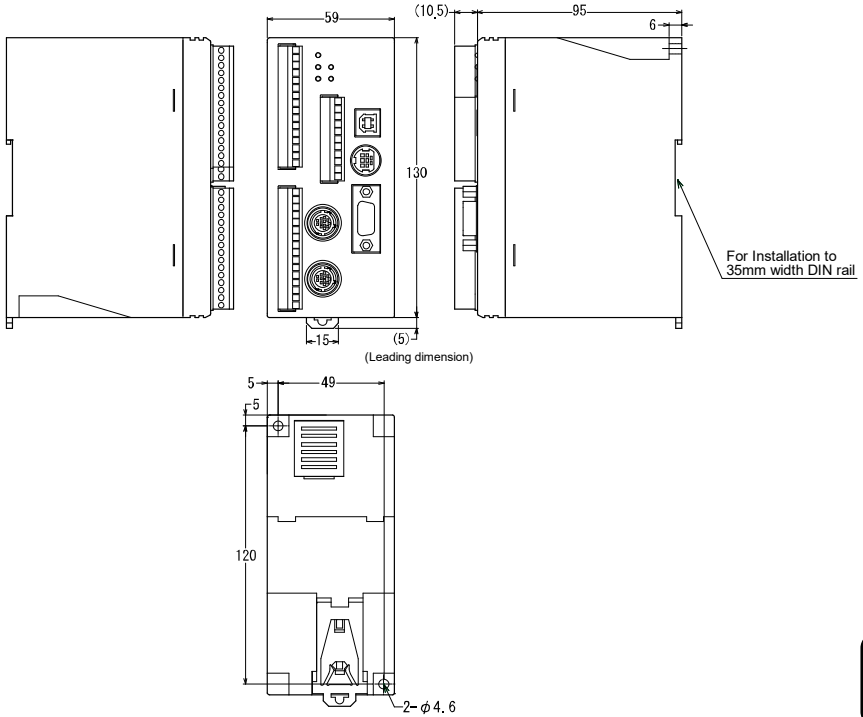

● Ethernet type [HL-C21C(E)/HL-C21C(E)-P]

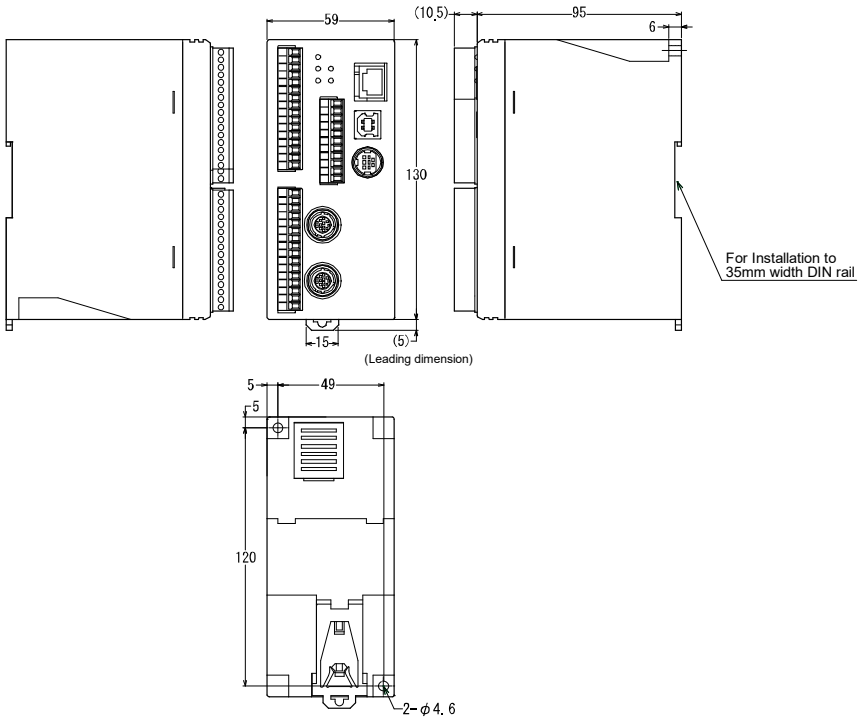

Unit: mm

■ Sensor Head

- 10mm type (HL-C201□□/HL-C201□□-MK)

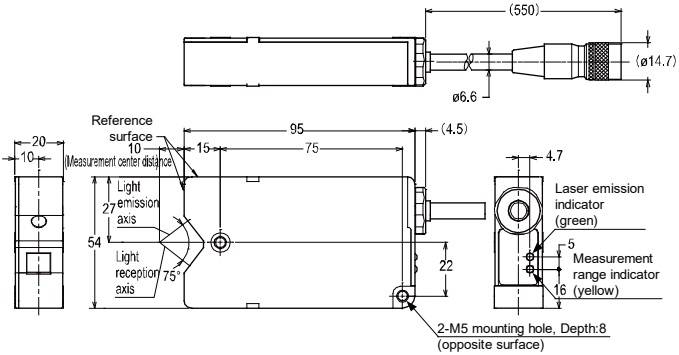

Unit: mm

- 30mm type (HL-C203B□/HL-C203B□-MK)

Diffuse reflection

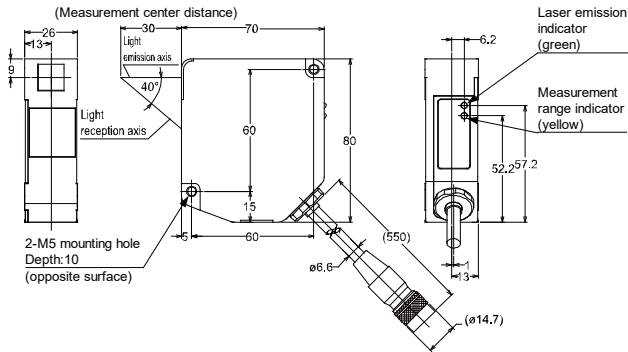

Unit: mm

Specular reflection

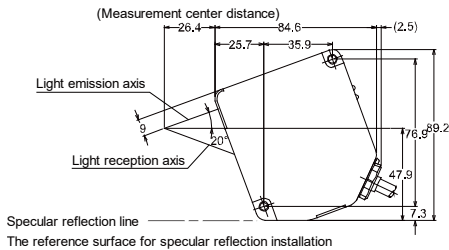

Unit: mm

- 50mm type(HL-C205B□/HL-C205B□-MK/HL-C205C□/HL-C205C□-MK)

Diffuse reflection

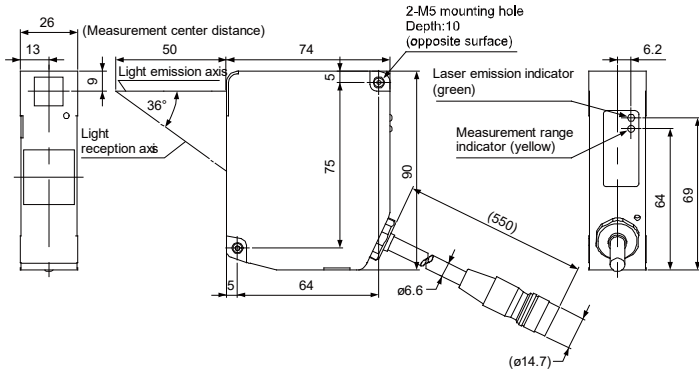

Unit: mm

Specular reflection

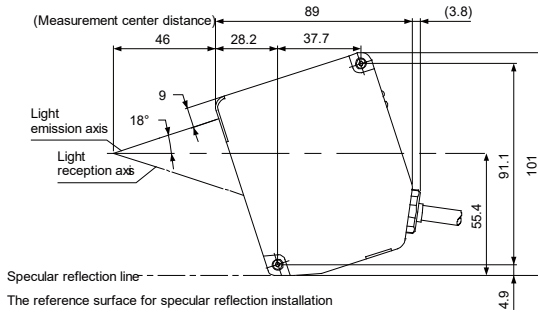

Unit: mm

- 85mm type(HL-C208B□/HL-C208B□-MK/HL-C208C□/HL-C208C□-MK)

Diffuse reflection

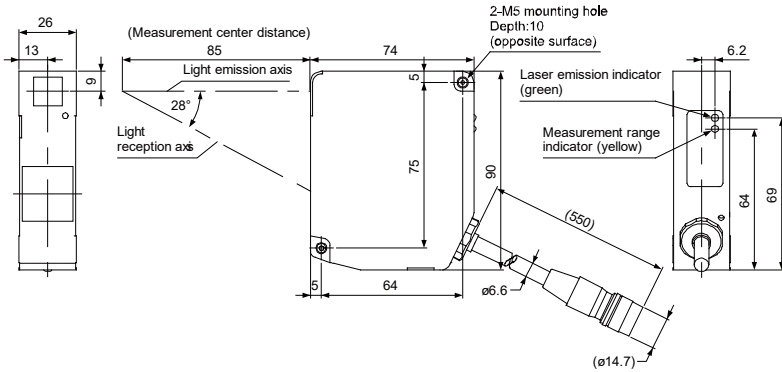

Unit: mm

Specular reflection

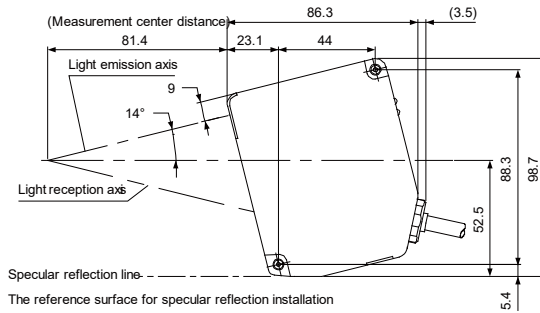

Unit: mm

- 110mm type(HL-C211B□/HL-C211B□-MK/HL-C211C□/HL-C211C□-MK)

Diffuse reflection

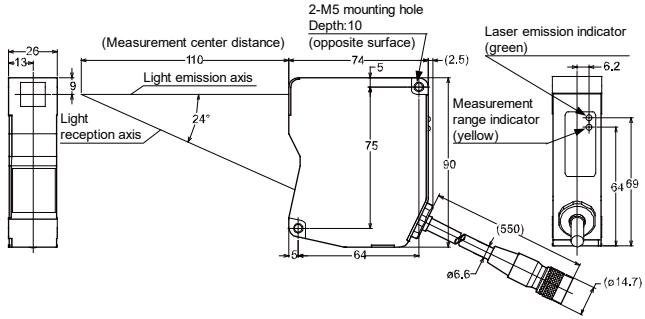

Unit: mm

Specular reflection

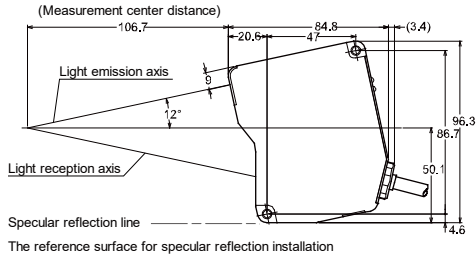

Unit: mm

● 350mm type(HL-C235BE/HL-C235BE-MK/HL-C235CE/HL-C235CE-MK)

Diffuse reflection

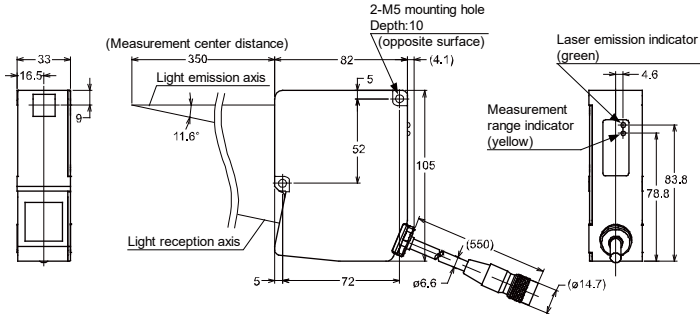

Unit: mm

Specular reflection

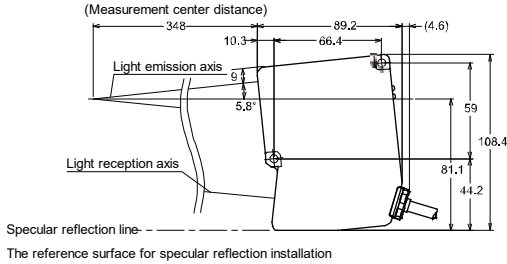

Unit: mm

●350mm type(HL-C235CE-W/HL-C235CE-WMK)

Diffuse reflection

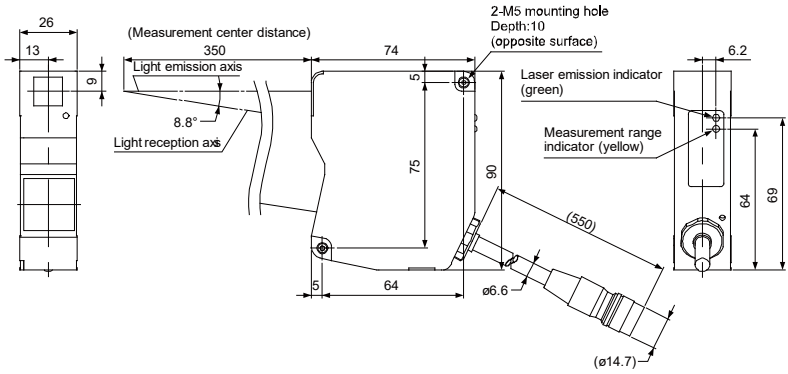

Unit: mm

● 8mm type [HL-C201A(E)-SP2/HL-C201A(E)-SP2M]

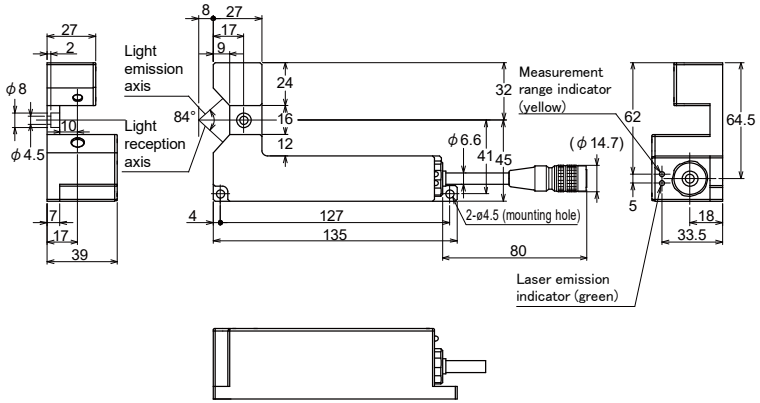

Unit: mm

● 15mm type [HL-C201A(E)-SP3/HL-C201A(E)-SP3M]

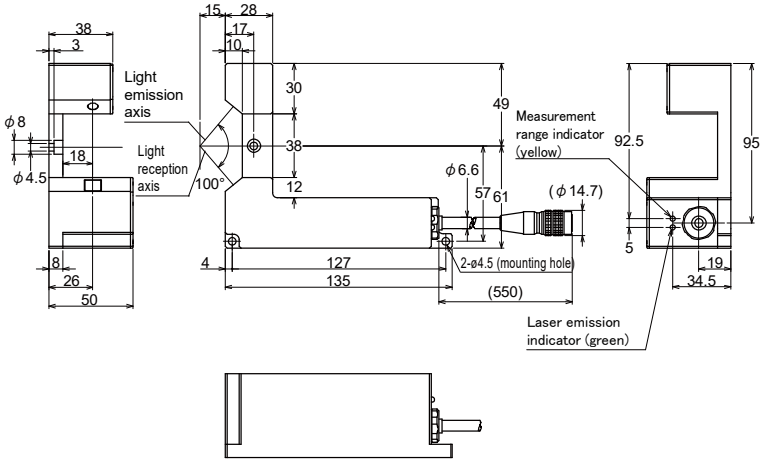

Unit: mm

<FDA-compliant sensor head>

- 30mm type (HL-C203F□/HL-C203F□-MK)

Diffuse reflection

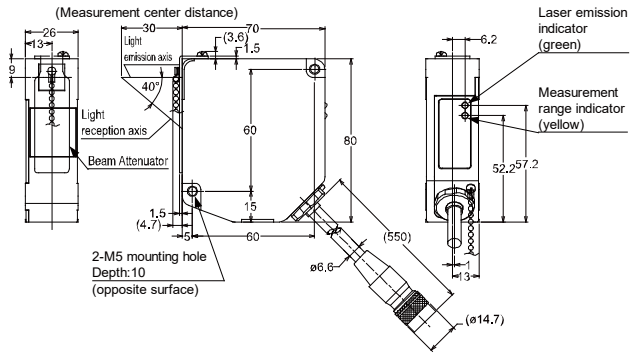

Specular reflection

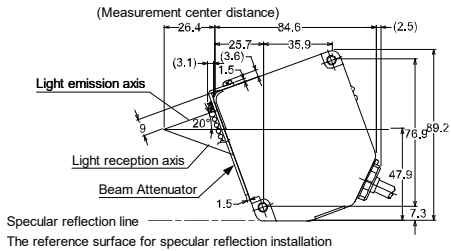

• 110mm type (HL-C211F□/HL-C211F□-MK/HL-C211F5□/HL-C211F5□-MK)

Diffuse reflection

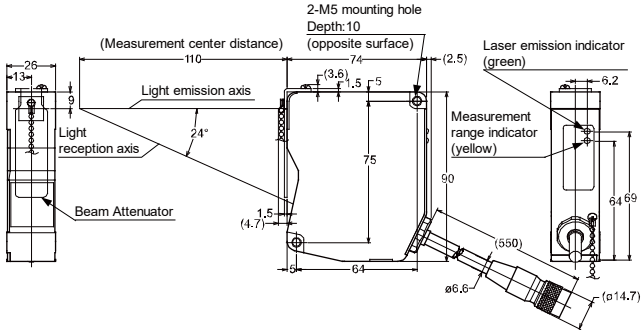

Unit: mm

Specular reflection

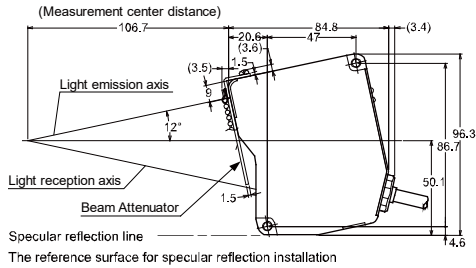

Unit: mm

■ ND Filter (HL-C2F01)

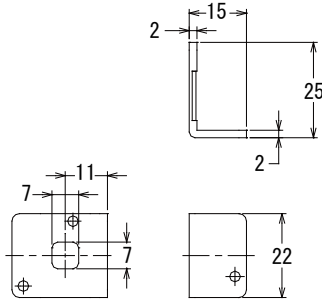

Unit: mm

Diffuse reflection (ND filter attached) (HL-203□□/HL-C203□□-MK)

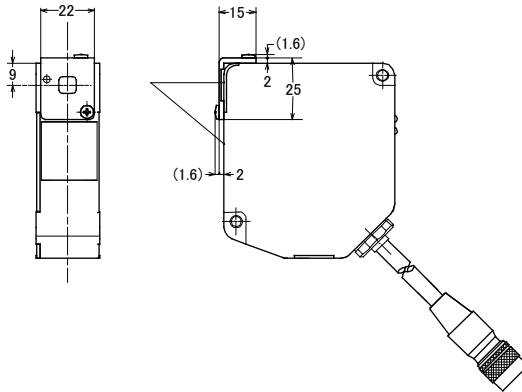

Unit: mm

Specular reflection (ND filter attached) (HL-203□□/HL-C203□□-MK)

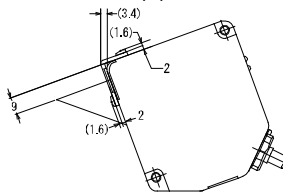

Unit: mm

* The measurement in installation is also the same in HL-C211□□/ HL-C211□□-MK.

* For FDA-compliant models, please remove the ND filter when mounting with a beam attenuator.

8-5 Characteristics

■ Beam Diameter

● 10mm type

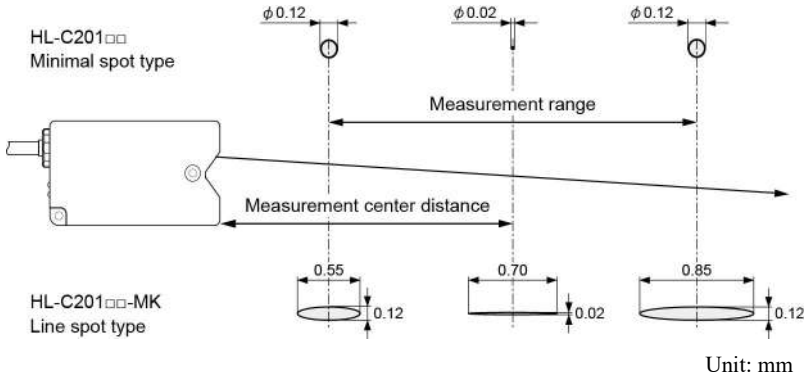

● 30mm type

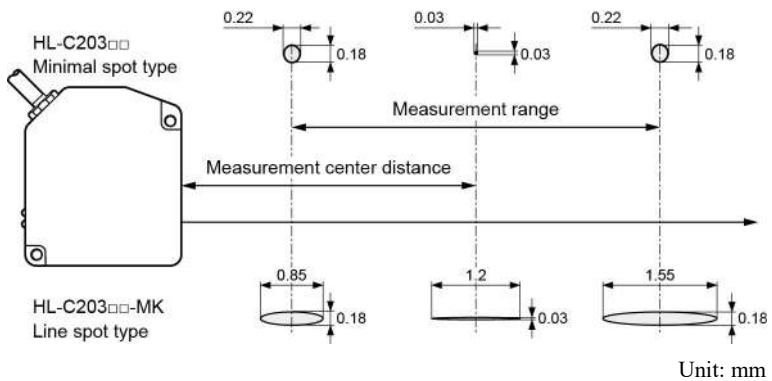

- 50mm type

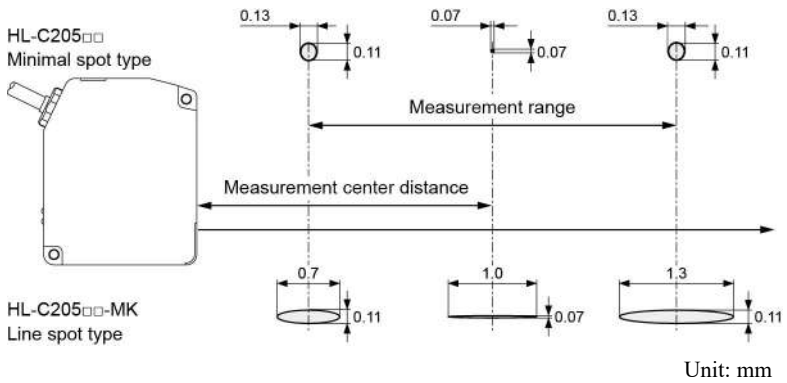

- 85mm type

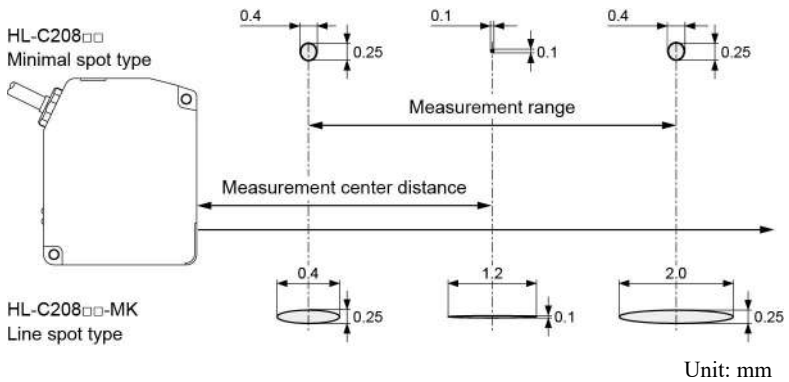

- 110mm type

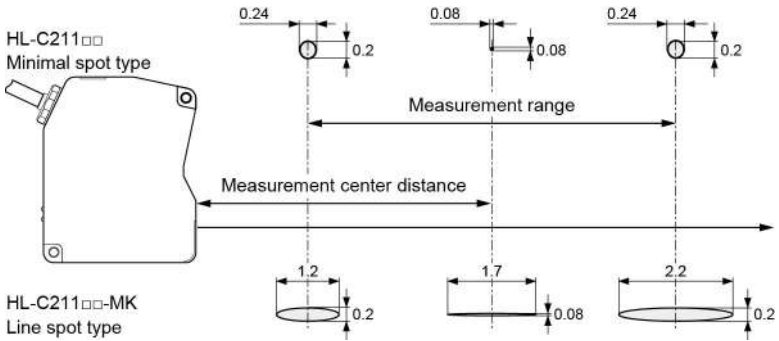

- 350mm type (HL-C235□E/HL-C235□E-MK)

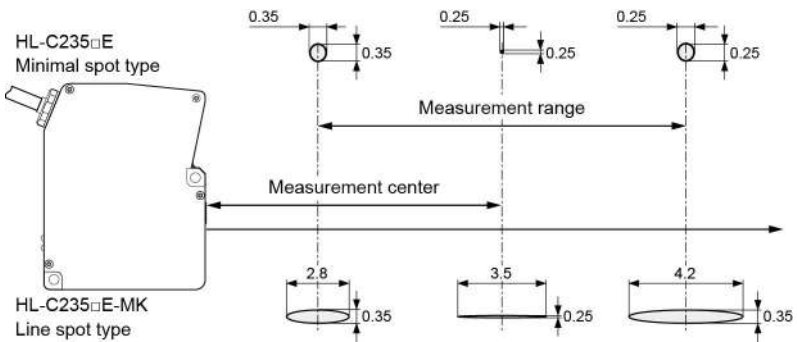

- 350mm type (HL-C235CE-W/HL-C235CE-WMK)

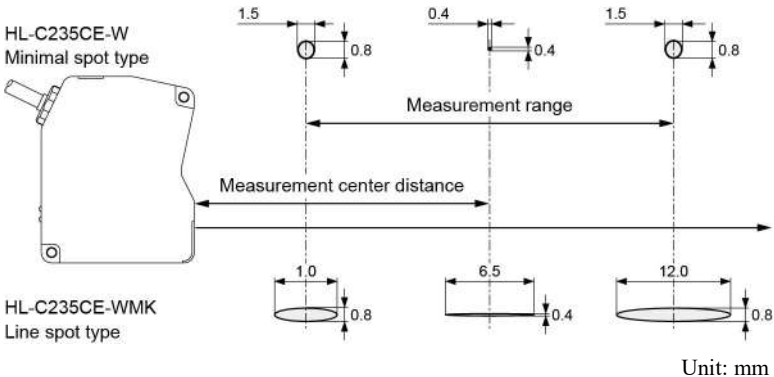

● 8mm type

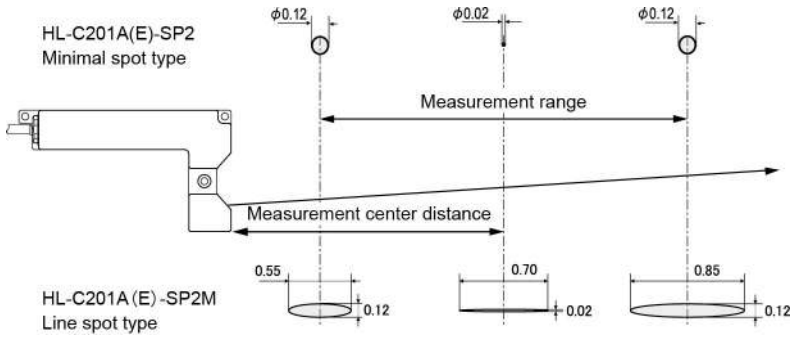

● 15mm type

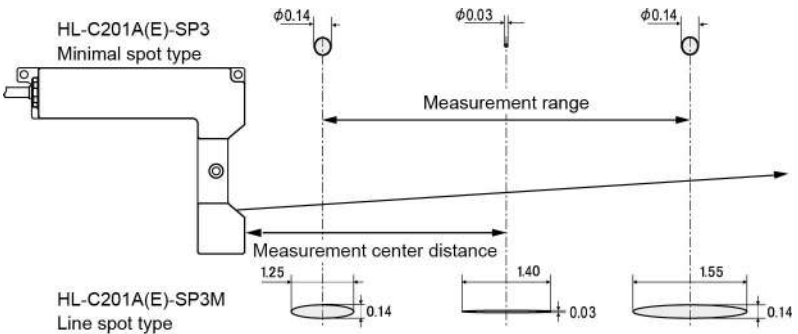

■ Mutual Interference Area

When installing 2 or more sensor heads side by side, mutual interference occurs if the laser spots from other sensor heads fall within the shaded areas in the figure below. Install sensor heads as the laser spots from other sensor heads fall outside the shaded areas.

- 30mm type (HL-C203□/HL-C203□-MK)

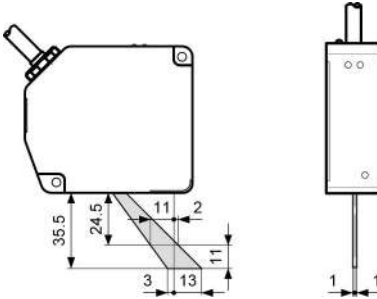

Unit: mm

- 50mm type (HL-C205□/HL-C205□-MK)

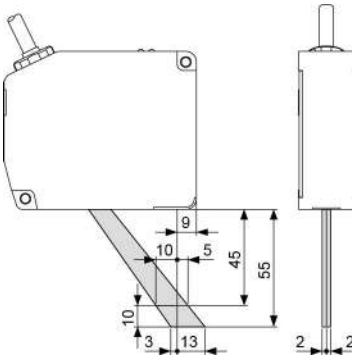

Unit: mm

- 85mm type (HL-C208□/HL-C208□-MK)

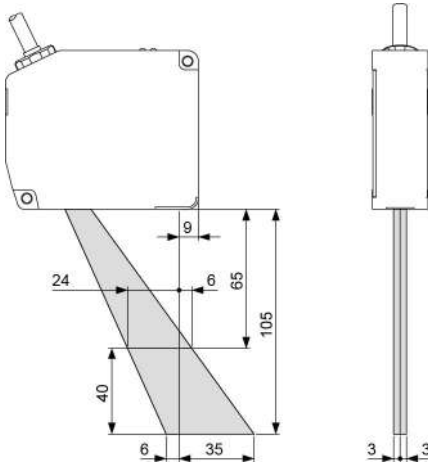

Unit: mm

- 110mm type (HL-C211□/HL-C211□-MK)

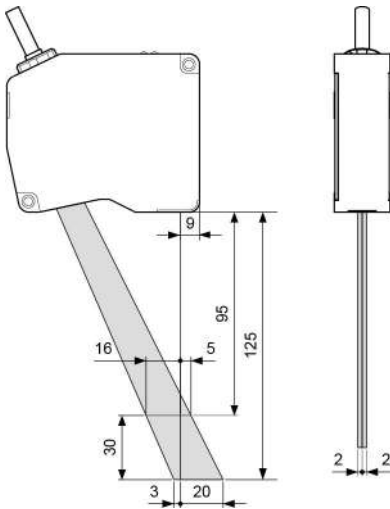

Unit: mm

- 350mm type (HL-C235□E/HL-C235□E-MK)

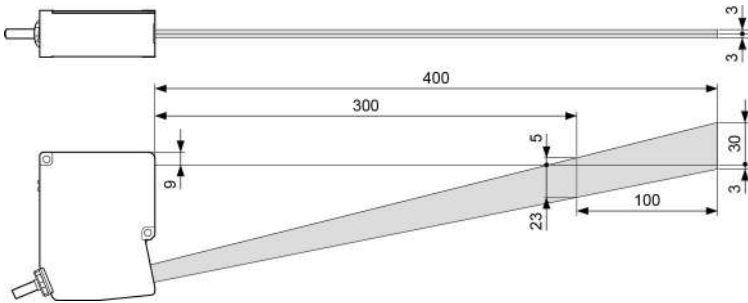

Unit: mm

- 350mm type (HL-C235CE-W/HL-C235CE-WMK)

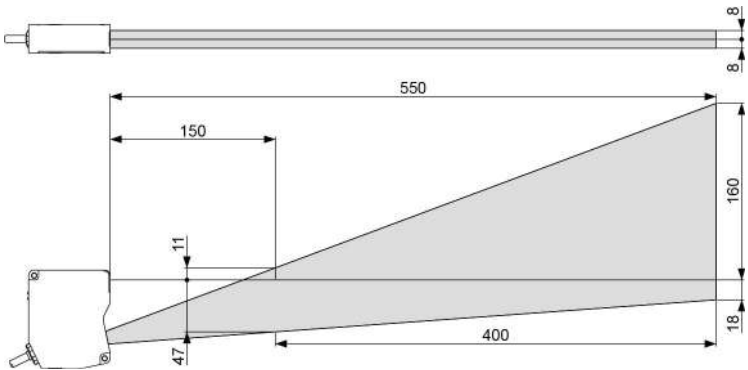

Unit: mm

❗ CHECK

If beam from the other sensor head enters into the mutual interference area when two sensor heads are connected, set the “Interference Prevention” function to ON.

→ “4-3-3 Common Setting” – “Interference Prevention”

■ Output Characteristics and Measurement Range Indicator

- 10mm type (HL-C201□/HL-C201□-MK)

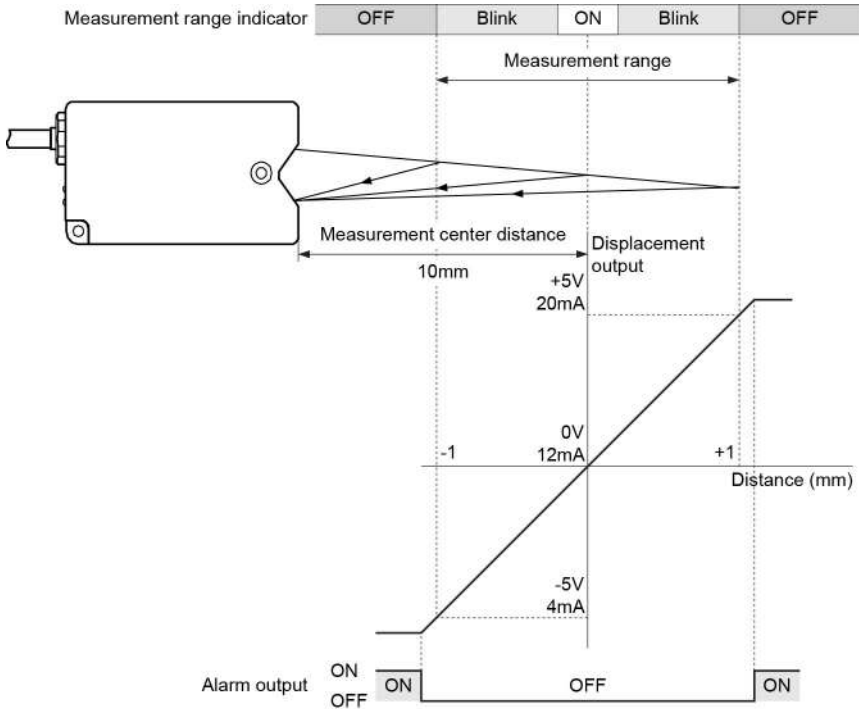

*1 In the figure above, analog output setting is used as the initial setting.

*2 The measurement range is limited between +0.1 and +1.0mm (in case the sampling cycle is 20 μ s) or between +0.8 and +1.0mm (in case the sampling cycle is 10 μ s).

*3 The measurement range indicator at sampling cycle of 20 μ s or 10 μ s lights up at the center of limited measurement range.

- 30mm type (HL-C203□/HL-C203□-MK)

Diffuse reflection

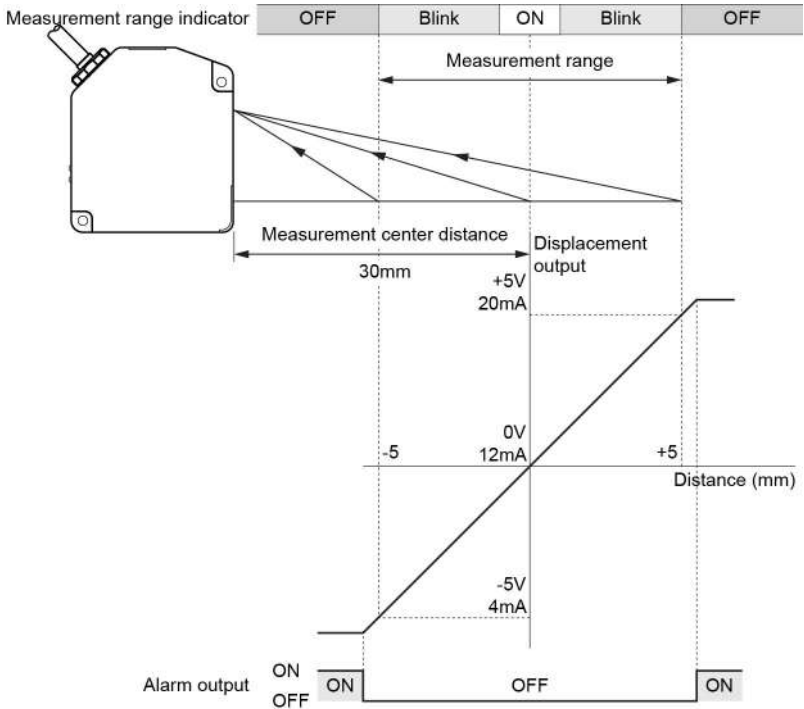

- *1 In the figure above, analog output setting is used as the initial setting.
- *2 The measurement range is limited between 0 and +5.0mm (in case the sampling cycle is 20 μ s) or between +3.8 and +5.0mm (in case the sampling cycle is 10 μ s).
- *3 The measurement range indicator at sampling cycle of 20 μ s or 10 μ s lights up at the center of limited measurement range.

Specular reflection

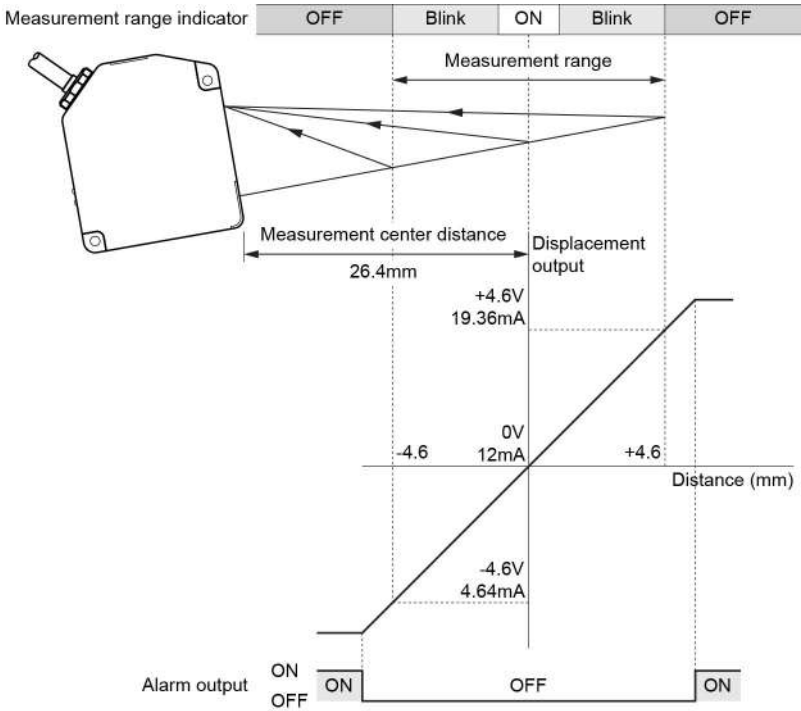

*1 In the figure above, analog output setting is used as the initial setting.

*2 The measurement range is limited between 0 and +4.6mm (in case the sampling cycle is 20μs) or between +3.6 and +4.6mm (in case the sampling cycle is 10μs).

*3 The measurement range indicator at sampling cycle of 20μs or 10μs lights up at the center of limited measurement range.

- 50mm type (HL-C205□/HL-C205□-MK)

Diffuse reflection

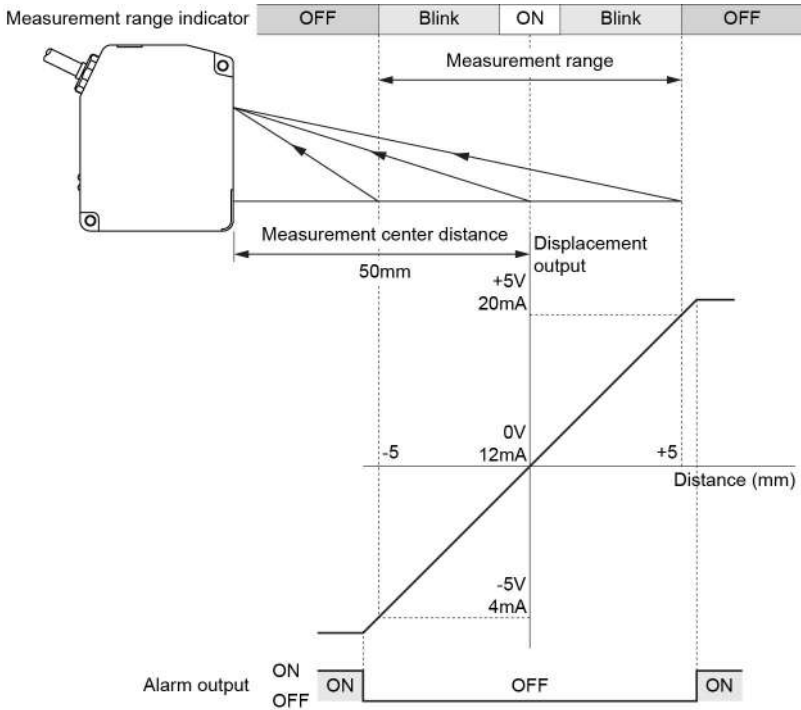

- *1 In the figure above, analog output setting is used as the initial setting.
- *2 The measurement range is limited between +0.5 and +5.0mm (in case the sampling cycle is 20 μ s) or between +4.7 and +5.0mm (in case the sampling cycle is 10 μ s).
- *3 The measurement range indicator at sampling cycle of 20 μ s or 10 μ s lights up at the center of limited measurement range.

Specular reflection

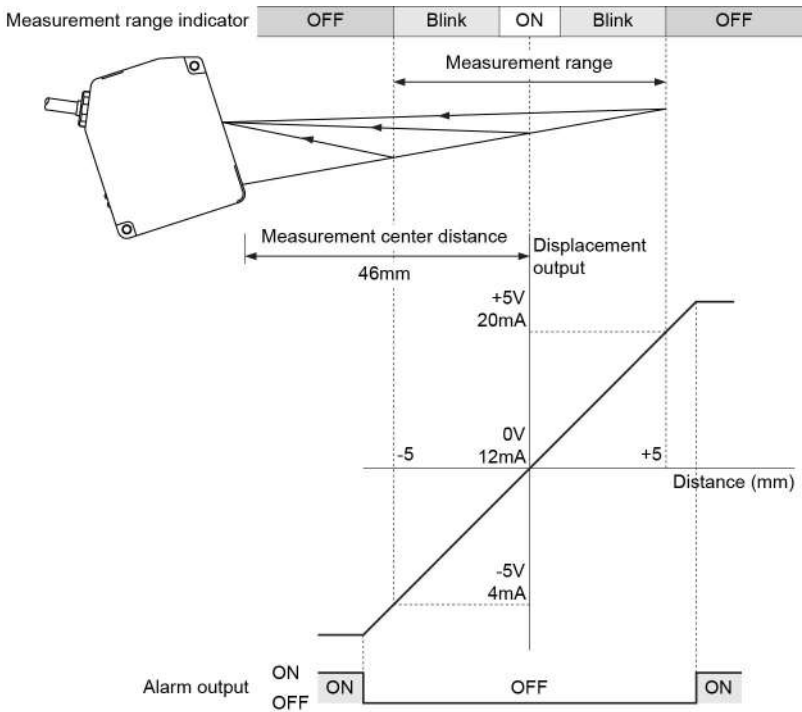

*1 In the figure above, analog output setting is used as the initial setting.

*2 The measurement range is limited between +0.5 and +5.0mm (in case the sampling cycle is 20 μ s) or between +4.6 and +5.0mm (in case the sampling cycle is 10 μ s).

*3 The measurement range indicator at sampling cycle of 20 μ s or 10 μ s lights up at the center of limited measurement range.

- 85mm type (HL-C208□/HL-C208□-MK)

Diffuse reflection

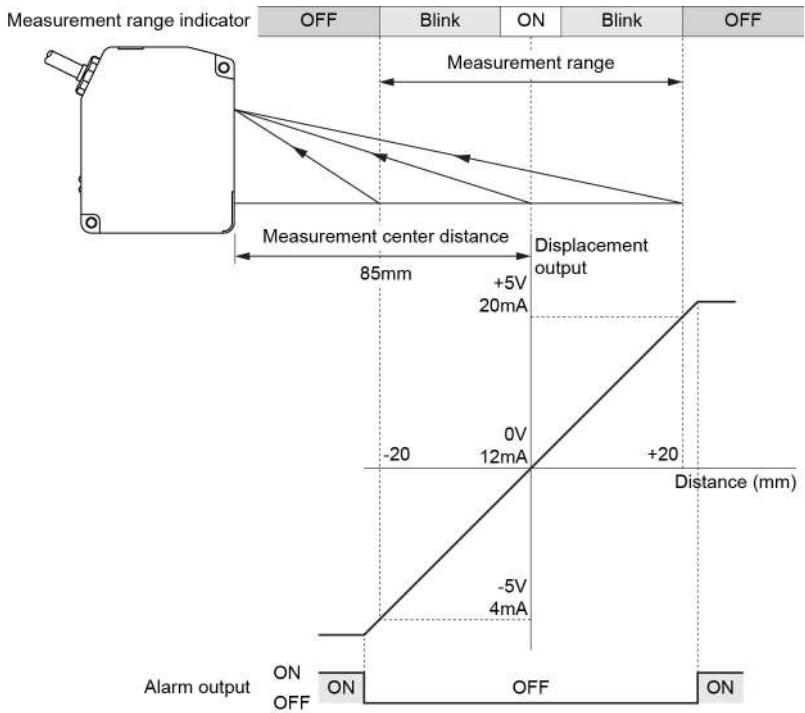

*1 In the figure above, analog output setting is used as the initial setting.

*2 The measurement range is limited between 0 and +20mm (in case the sampling cycle is 20 μ s) or between +18 and +20mm (in case the sampling cycle is 10 μ s).

*3 The measurement range indicator at sampling cycle of 20 μ s or 10 μ s lights up at the center of limited measurement range.

Specular reflection

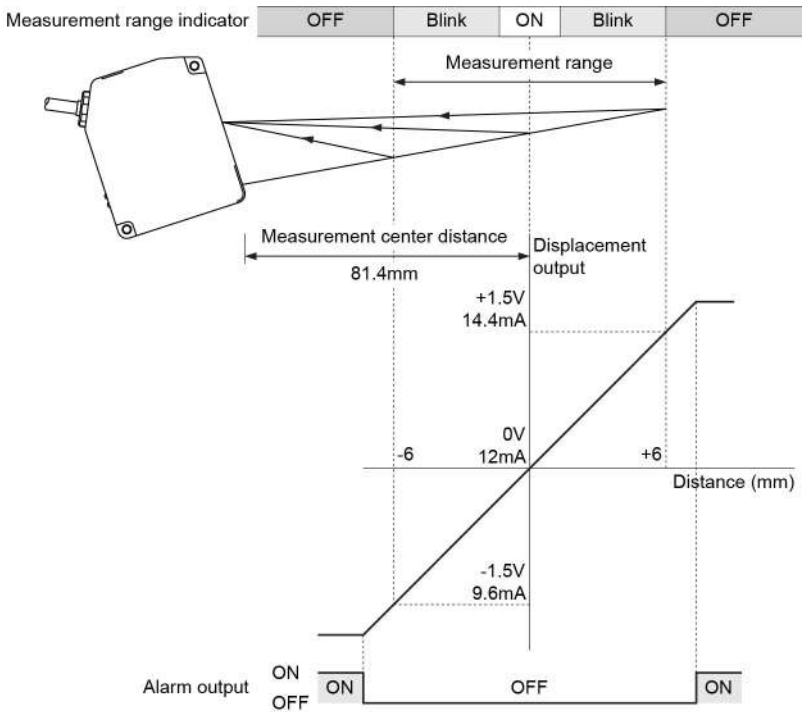

*1 In the figure above, analog output setting is used as the initial setting.

*2 The measurement range is limited between 0 and +6mm (in case the sampling cycle is 20 μ s) or unmeasurable (in case the sampling cycle is 10 μ s).

*3 The measurement range indicator at sampling cycle of 20 μ s or 10 μ s lights up at the center of limited measurement range.

- 110mm type (HL-C211□/HL-C211□-MK)

Diffuse reflection

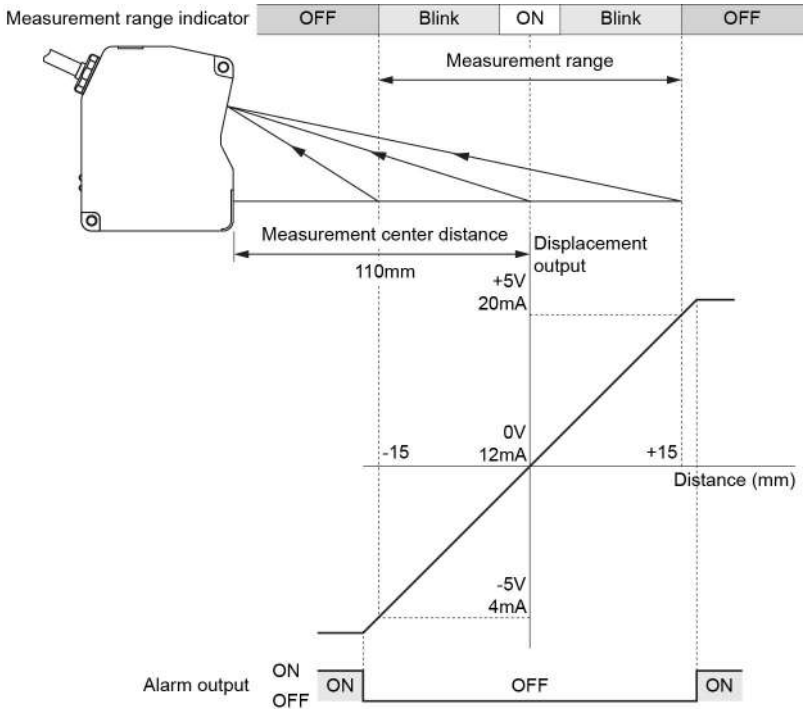

*1 In the figure above, analog output setting is used as the initial setting.

*2 The measurement range is limited between +0.5 and +15.0mm (in case the sampling cycle is 20 μ s) or between +12.5 and +15.0mm (in case the sampling cycle is 10 μ s).

*3 The measurement range indicator at sampling cycle of 20 μ s or 10 μ s lights up at the center of limited measurement range.

Specular reflection

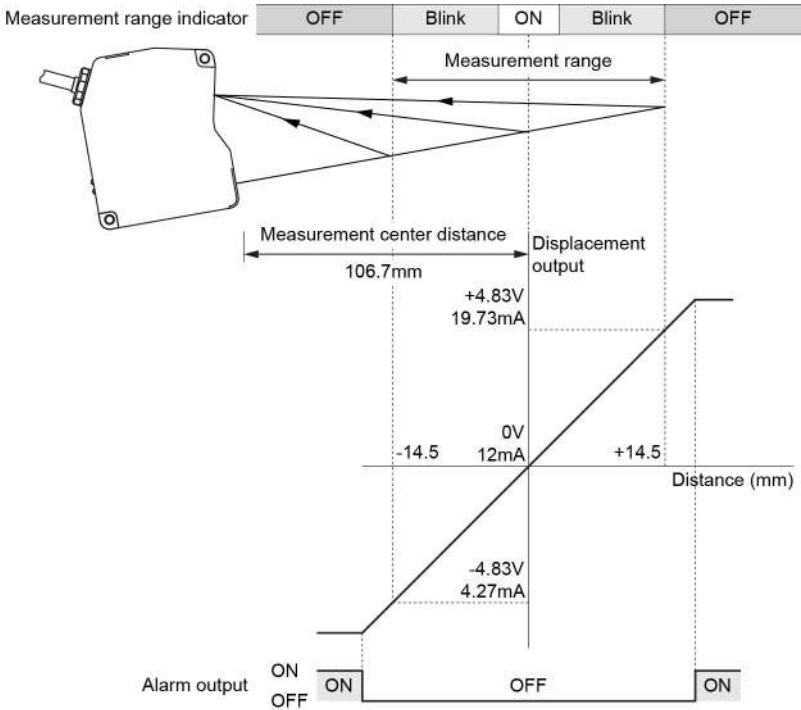

*1 In the figure above, analog output setting is used as the initial setting.

*2 The measurement range is limited between +0.5 and +14.5mm (in case the sampling cycle is 20 μ s) or between +12.5 and +14.5mm (in case the sampling cycle is 10 μ s).

*3 The measurement range indicator at sampling cycle of 20 μ s or 10 μ s lights up at the center of limited measurement range.

- 350mm type (HL-C235□E/HL-C235□E-MK)

Diffuse reflection

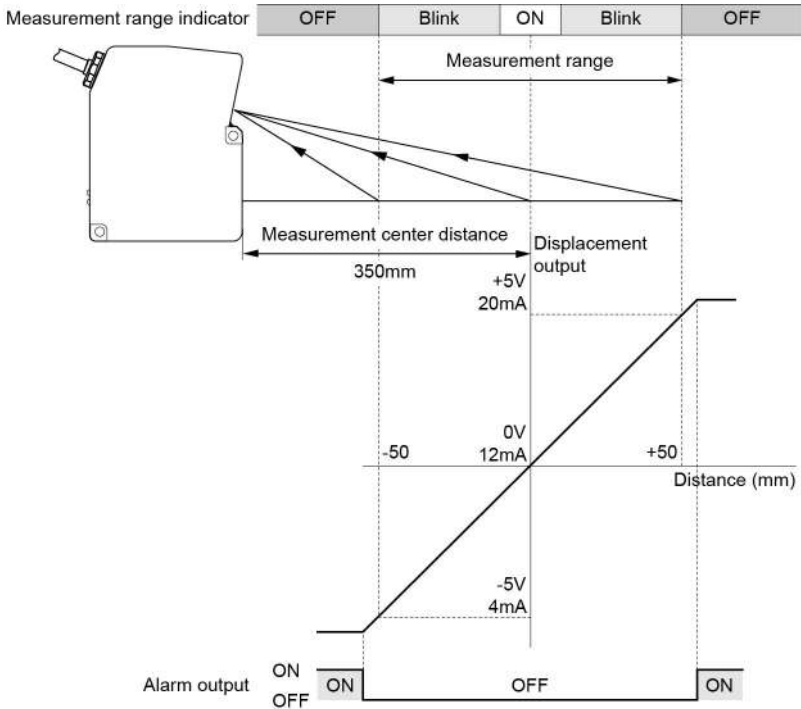

*1 In the figure above, analog output setting is used as the initial setting.

*2 The measurement range is limited between +0.0 and +50mm (in case the sampling cycle is 20 μ s) or between +36 and +50mm (in case the sampling cycle is 10 μ s).

*3 The measurement range indicator at sampling cycle of 20 μ s or 10 μ s lights up at the center of limited measurement range.

Specular reflection

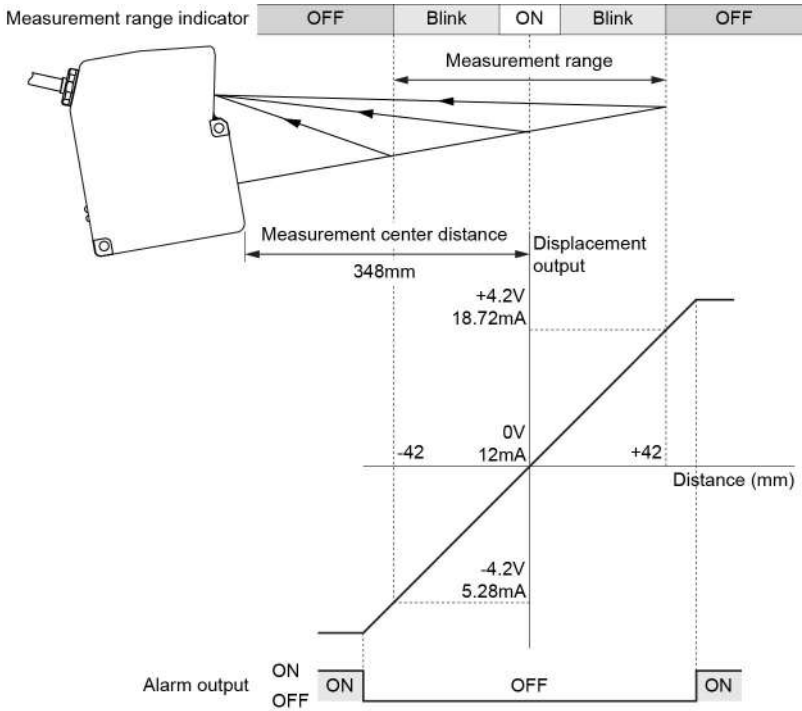

*1 In the figure above, analog output setting is used as the initial setting.

*2 The measurement range is limited between +0.0 and +42mm (in case the sampling cycle is 20 μ s) or between +36 and +42mm (in case the sampling cycle is 10 μ s).

*3 The measurement range indicator at sampling cycle of 20 μ s or 10 μ s lights up at the center of limited measurement range.

- 350mm type (HL-C235CE-W/HL-C235CE-WMK)

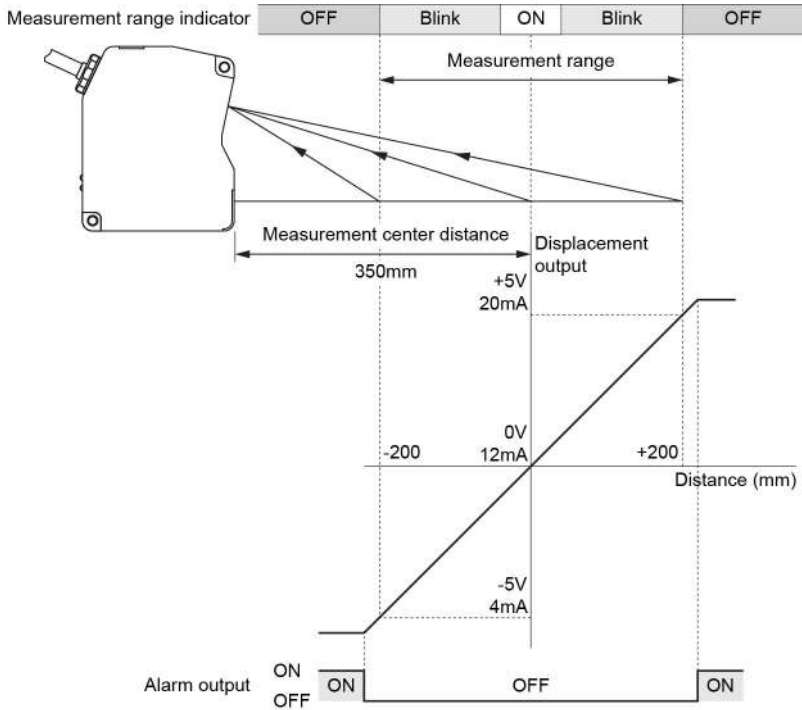

*1 In the figure above, analog output setting is used as the initial setting.

*2 The measurement range is limited between -70 and +200mm (in case the sampling cycle is 20 μ s) or between +100 and +200mm (in case the sampling cycle is 10 μ s).

*3 The measurement range indicator at sampling cycle of 20 μ s or 10 μ s lights up at the center of limited measurement range.

● 8mm type [HL-C201A(E)-SP2/HL-C201A(E)-SP2M]

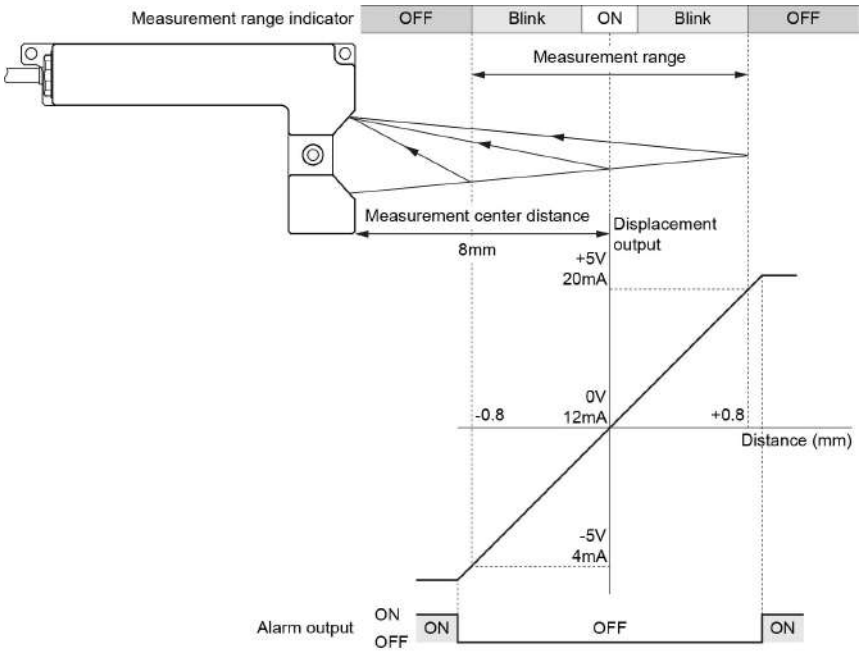

*1 In the figure above, analog output setting is used as the initial setting.

*2 The measurement range is limited between +0.1 and +0.8mm (in case the sampling cycle is 20 μ s) or between +0.7 and +0.8mm (in case the sampling cycle is 10 μ s).

*3 The measurement range indicator at sampling cycle of 20 μ s or 10 μ s lights up at the center of limited measurement range.

- 15mm type [HL-C201A(E)-SP3/HL-C201A(E)-SP3M]

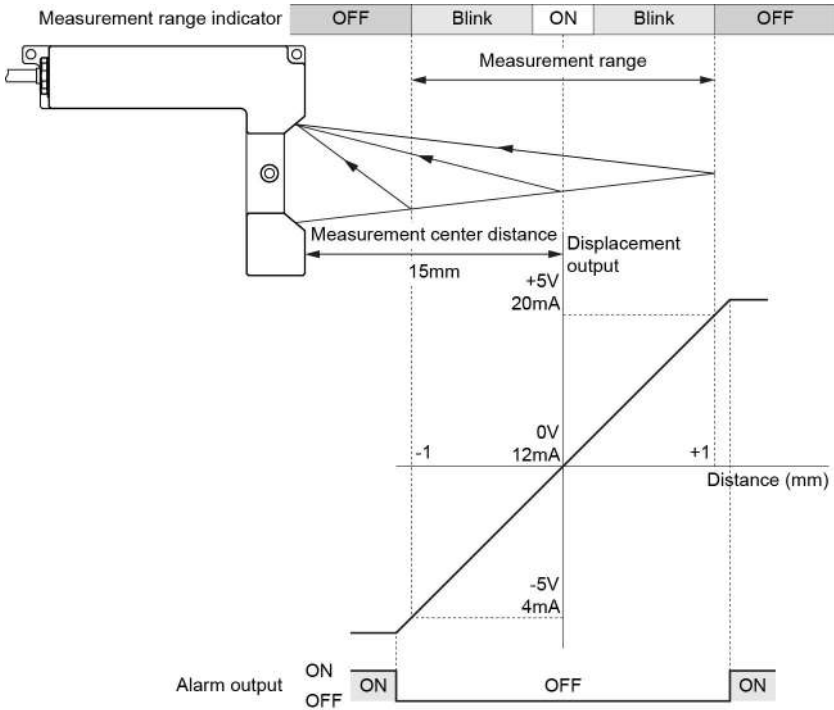

*1 In the figure above, analog output setting is used as the initial setting.

*2 The measurement range is limited between +0.1 and +1.0mm (in case the sampling cycle is 20 μ s) or between +0.8 and +1.0mm (in case the sampling cycle is 10 μ s).

*3 The measurement range indicator at sampling cycle of 20 μ s or 10 μ s lights up at the center of limited measurement range.

MEMO



Appendix



1 Index2

Apx



1 Index

–A–

Accessories list 1-3
 Accumulation amount 4-79
 Adjust the analog output 4-45
 Alarm delay times 4-14
 Alarm output delay 4-51
 Alarm setting and outputs 4-84
 Analog output at alarm 4-48
 Analog output at data unfixed 4-49
 Analog output circuit 2-7
 Analog scaling 4-45
 Analysis mode 4-36

–B–

Basic operation 3-6
 BCC 5-13
 Beam diameter 8-30
 Buffering mode 4-77
 Buffering operation 4-77
 Buffering procedure 4-76
 Buffering rate 4-79
 Buffering setting 4-75
 Buffering type 4-79

–C–

Calculation 4-23
 Calibration 4-19
 Cautions on handling laser light 14
 CE 18
 Change Indication Unit 4-61
 Characteristics 8-30
 Chattering prevention of terminal
 input 4-56
 Classification of function 4-3
 Command classification 5-7
 Command list 5-14
 Common setting 4-53
 Communication COM port 4-69

Communication specifications 5-2
 Compact programmable display 1-8
 Conditions when output data
 become unfixed 4-85
 Connection method of power supply 1-15
 Connection method of terminal
 block 1-15
 Connection of Intelligent Monitor
 AiM (PC) 1-17
 Programmable display operation 3-1
 Console setting 4-72
 Controller 1-6
 Controller specifications 8-2
 Correct handling 8
 Correct the deviation of the
 measurement value 4-19
 Corrective actions 7-2

–D–

Data flow 4-2
 Data read 4-83
 Data transmission/reception 5-5
 Data unfixed status 4-85
 Digit number of measurement value 4-52
 Digital output at alarm 4-50
 Display update cycle of
 measurement value 4-59
 Display waveform of received light
 intensity 3-14

–E–

Emission adjustment 4-10
 Emitted light intensity search 4-13
 Explanation of function details 4-84
 Explanation of functions 4-1
 Export control 24
 External Communication Control 5-1

-F-

FDA	19
Filter operation	4-37
Final data point	4-82
First measurement	3-6
Function list & initial values	4-3
Functions and arrangements of I/O terminal block	2-2

-G-

Grounding	12
-----------	----

-H-

Head setting	4-7
Hold	4-35
Hold the maximum value	4-36

-I-

I/O circuit	2-4
I/O terminal block	2-1, 2-2, 2-3
Initialization	4-66, 7-7
Inspection	6-2
Installation	13
Installation direction of sensor head	1-10
Installation environment	8
Installation method	1-9
Installation mode	4-7, 4-16, 4-18
Instantaneous power failure	11
Insulation Resistance	10
Interference Prevention	4-58
Interlock circuit	2-6

-J-

JIS/IEC	14
Judgment Output Off Delay	4-57

-L-

Laser control terminal block	2-2
Lock	7-7

-M-

Maintenance	6-2
Maintenance and Inspection	6-1
Maintenance instructions	6-2
Major inspection items	6-2
Measurement mode	4-8
Measurement of glass	4-8
Measurement of metal	4-8
Measurement of pattern glass	4-8
Measurement surface reference	4-15
Measures to noise	10
Memory change	4-64
Memory copy	4-65
Memory save and terminal setting	4-88
Mounting ND filter	1-13
Mutual interference area	8-32

-N-

ND filter	8-28
ND filter specifications	8-20

-O-

Offset	4-40
Operation Coefficient	4-39
Operation screens	3-2
OUT setting	4-23
Output characteristics and measurement range	8-34
Output selection	4-23
Output setting copy	4-62
Outside dimension	8-22

-P-

Part names and functions	1-6
Peak Recognition Sensitivity	4-21
Power supply	11
Priority setting of memory change	4-63
Protective structure	9

-R-

Received light intensity at peak	3-14
----------------------------------	------

Refractive index	4-29
Refractive index calculation	4-27
Remote interlock	23
Request communication data format	5-8
Reset	4-34
Response communication data format	5-9
RS-232C Output	4-70

–S–

Safety precautions	7
Sample trigger accumulation amount	4-81
Sampling period	4-53
Save	4-68
Screen transition diagram	3-10
Self-stop	4-77
Sensor head	1-7
Sensor head model	8-6, 8-7
Sensor head specifications	8-6
Specifications	8-1
Status readout	4-82
Supplemental explanation	4-84
System components	1-3
System configuration	1-2
System setting	4-59

–T–

Terminal input control	4-55
------------------------	------

Timing	4-33
Timing chart	2-8
Transparent object	4-25
Trigger conditions	4-80
Trigger counter readout	4-82
Trigger delay	4-81
Trigger point	4-81
Troubleshooting	7-1
Type and format of commands	5-5

–U–

Upper/lower Hysteresis of judgment output	4-43
Upper/lower limit value of judgment output	4-41
USB communication control	5-24
Use environment	8

–V–

Voltage Resistance	10
--------------------	----

–W–

Warming up time	10
Wiring method	1-16

–Z–

Zero set	4-31
----------	------

MEMO

Apx

Revision history

Released date	Revision No.
October 2007	First release
May 2008	Second release
July 2008	Third release
October 2008	Fourth release
September 2009	Fifth release
June 2010	Sixth release
February 2011	Seventh release
December 2011	Eighth release
June 2013	Ninth release
November 2013	Tenth release
July 2014	Eleventh release
May 2017	Twelfth release
January 2019	Thirteenth release
-	Fourteenth release
-	Fifteenth release
-	Sixteenth release
-	Seventeenth release
December 2020	Eighteenth release
April 2021	Nineteenth release
October 2021	Twentyth release

Please contact

Panasonic Corporation
Panasonic Industrial Devices SUNX Co., Ltd.
<https://panasonic.net/id/pidsx/global>

Please visit our website for inquiries and about our sales network.

October, 2021

© Panasonic Industrial Devices SUNX Co., Ltd. 2021
WUME-HLC2-20