

# NA40 SERIES

Related Information

- General terms and conditions ..... F-3
- Selection guide ..... P.419~
- Glossary of terms / General precautions ..... P.1549~ / P.1552~
- Korea's S-mark ..... P.1602



**!** Make sure to use safety light curtains when using a sensing device for personnel protection. Refer to p.455~ for details of safety light curtains.



[panasonic.net/id/pidsx/global](http://panasonic.net/id/pidsx/global)

## Slim and smart

### ORDER GUIDE

**Sensors** Mating cable is not supplied with the sensor. Please order it separately.

Type	Appearance	Sensing range	Model No.	Number of beam channels	Sensing height (mm in)	Output			
Area sensor		5 m 16.404 ft	NA40-4	4	120 4.724	NPN open-collector transistor			
			NA40-6	6	200 7.874				
			NA40-8	8	280 11.024				
			NA40-10	10	360 14.173				
			NA40-12	12	440 17.323				
			NA40-14	14	520 20.472				
			NA40-16	16	600 23.622				
			NA40-20	20	760 29.921				
			NA40-24	24	920 36.221				
			With spatter protection hood		5 m 16.404 ft		NA40-4-H	4	120 4.724
							NA40-6-H	6	200 7.874
							NA40-8-H	8	280 11.024
	NA40-10-H	10					360 14.173		
	NA40-12-H	12					440 17.323		
	NA40-14-H	14					520 20.472		
	NA40-16-H	16					600 23.622		
	NA40-20-H	20					760 29.921		
	NA40-24-H	24					920 36.221		

Note: The model No. with "P" shown on the label affixed to the product is the emitter, "D" shown on the label is the receiver.

- FIBER SENSORS
- LASER SENSORS
- PHOTOELECTRIC SENSORS
- MICRO PHOTOELECTRIC SENSORS
- AREA SENSORS**
- SAFETY LIGHT CURTAINS / SAFETY COMPONENTS
- PRESSURE / FLOW SENSORS
- INDUCTIVE PROXIMITY SENSORS
- PARTICULAR USE SENSORS
- SENSOR OPTIONS
- SIMPLE WIRE-SAVING UNITS
- WIRE-SAVING SYSTEMS
- MEASUREMENT SENSORS
- STATIC CONTROL DEVICES
- LASER MARKERS
- PLC
- HUMAN MACHINE INTERFACES
- ENERGY MANAGEMENT SOLUTIONS
- FA COMPONENTS
- MACHINE VISION SYSTEMS
- UV CURING SYSTEMS
- Selection Guide
- Slim Body
- Picking
- Other Products
- NA40**

## ORDER GUIDE

### Products that obtained Korea's S-mark certification

We offer products that have obtained Korea's S-mark certification (excluding the sensors with spatter protection hood). When ordering this type, suffix "-K" to the model No. (e.g.) **NA40-4** with Korea's S-mark certification is "**NA40-4-K**".

**Mating cables** Mating cable is not supplied with the sensor. Please order it separately.

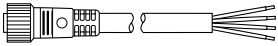
Appearance	Model No.	Description
	<b>NA40-CC3</b>	Length: 3 m <b>9.843 ft</b> Net weight: 600 g approx. (two cables)
	<b>NA40-CC7</b>	Length: 7 m <b>22.966 ft</b> Net weight: 950 g approx. (two cables)
		0.5 mm <sup>2</sup> 3-core (for receiver: 4-core) cabtyre cable with connector on one end, two cables per set. Cable outer diameter: ø6.7 mm <b>ø0.264 in</b> Connector outer diameter: ø14 mm <b>ø0.551 in</b> max. Cable color: Gray (for emitter) Black (for receiver)

### Accessory

- **MS-NA40-1** (Sensor mounting bracket)

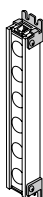

Four bracket set  
Four M5 (length 40 mm **1.575 in**)  
truss head screws, four nuts and  
four spring washers are attached.

### Individual units and associated components can be purchased separately

Designation	Number of beam channels	Model No.	
		Emitter	Receiver
Main unit	4	<b>NA40-MUP</b>	<b>NA40-MUD</b>
Sub-unit	4	<b>NA40-4SUP</b>	<b>NA40-4SUD</b>
End unit	2	<b>NA40-2EUP</b>	<b>NA40-2EUD</b>
	4	<b>NA40-4EUP</b>	<b>NA40-4EUD</b>
End cap (Note)	—	<b>NA40-ECP</b>	<b>NA40-ECD</b>

Note: It is required only for **NA40-4** or **NA40-4-H**.

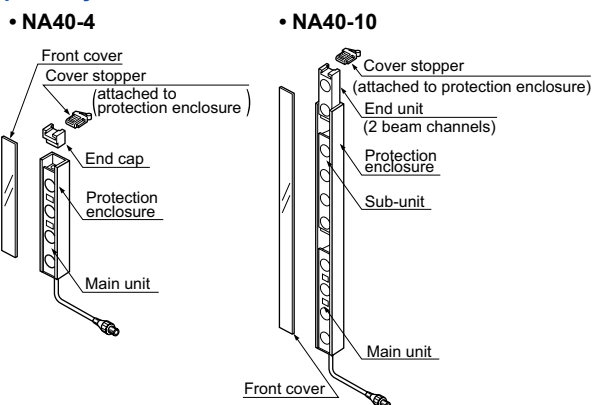

Applicable beam channels		4 beam channels	6 beam channels	8 beam channels	10 beam channels	12 beam channels	14 beam channels	16 beam channels	20 beam channels	24 beam channels
		Model No.	Model No.	Model No.	Model No.	Model No.	Model No.	Model No.	Model No.	Model No.
Protection enclosure	Model No.	<b>MC-NA40-4</b>	<b>MC-NA40-6</b>	<b>MC-NA40-8</b>	<b>MC-NA40-10</b>	<b>MC-NA40-12</b>	<b>MC-NA40-14</b>	<b>MC-NA40-16</b>	<b>MC-NA40-20</b>	<b>MC-NA40-24</b>
	With spatter protection hood	<b>MC-NA40-4H</b>	<b>MC-NA40-6H</b>	<b>MC-NA40-8H</b>	<b>MC-NA40-10H</b>	<b>MC-NA40-12H</b>	<b>MC-NA40-14H</b>	<b>MC-NA40-16H</b>	<b>MC-NA40-20H</b>	<b>MC-NA40-24H</b>
Front cover	Model No.	<b>FC-NA40-4</b>	<b>FC-NA40-6</b>	<b>FC-NA40-8</b>	<b>FC-NA40-10</b>	<b>FC-NA40-12</b>	<b>FC-NA40-14</b>	<b>FC-NA40-16</b>	<b>FC-NA40-20</b>	<b>FC-NA40-24</b>

Note: The model Nos. given above denote a single unit, not a pair of units.

## OPTIONS

Applicable beam channels		4 beam channels	6 beam channels	8 beam channels	10 beam channels	12 beam channels	14 beam channels	16 beam channels	20 beam channels	24 beam channels
		Model No.	Model No.	Model No.	Model No.	Model No.	Model No.	Model No.	Model No.	Model No.
Slit mask	Model No.	<b>OS-NA40-4</b>	<b>OS-NA40-6</b>	<b>OS-NA40-8</b>	<b>OS-NA40-10</b>	<b>OS-NA40-12</b>	<b>OS-NA40-14</b>	<b>OS-NA40-16</b>	<b>OS-NA40-20</b>	<b>OS-NA40-24</b>

Note: The model Nos. given above denote a single unit, not a pair of units.

### Slit mask

- **OS-NA40-□**

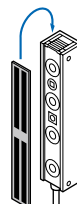

### Sensing range

- Slit on emitter side: 1.3 m **4.265 ft**
- Slit on receiver side: 3 m **9.843 ft**
- Slit on both sides: 0.8 m **2.625 ft**

FIBER SENSORS

LASER SENSORS

PHOTO-ELECTRIC SENSORS

MICRO PHOTO-ELECTRIC SENSORS

AREA SENSORS

SAFETY LIGHT CURTAINS / SAFETY COMPONENTS

PRESSURE / FLOW SENSORS

INDUCTIVE PROXIMITY SENSORS

PARTICULAR USE SENSORS

SENSOR OPTIONS

SIMPLE WIRE-SAVING UNITS

WIRE-SAVING SYSTEMS

MEASUREMENT SENSORS

STATIC CONTROL DEVICES

LASER MARKERS

PLC

HUMAN MACHINE INTERFACES

ENERGY MANAGEMENT SOLUTIONS

FA COMPONENTS

MACHINE VISION SYSTEMS

UV CURING SYSTEMS

Selection Guide

Slim Body

Picking

Other Products

**NA40**

## OPTIONS

### Large indicator for area sensor

#### • SF-IND

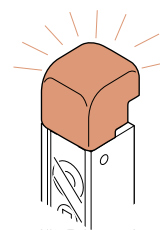

The large indicator can be easily mounted on the sensor head at the top. It also can be mounted on an area sensor already being used.

Designation	Model No.	Description
Large indicator for area sensor	<b>SF-IND</b>	With the large indicators put on the sensors, the operation is easily observable from various directions. Orange.

Note: Two **SF-INDs** are required if they are to be mounted on, both, the emitter and the receiver.

## SPECIFICATIONS

Item	Number of beam channels	4	6	8	10	12	14	16	20	24
	Model No.	<b>NA40-4</b>	<b>NA40-6</b>	<b>NA40-8</b>	<b>NA40-10</b>	<b>NA40-12</b>	<b>NA40-14</b>	<b>NA40-16</b>	<b>NA40-20</b>	<b>NA40-24</b>
	With spatter protection hood	<b>NA40-4-H</b>	<b>NA40-6-H</b>	<b>NA40-8-H</b>	<b>NA40-10-H</b>	<b>NA40-12-H</b>	<b>NA40-14-H</b>	<b>NA40-16-H</b>	<b>NA40-20-H</b>	<b>NA40-24-H</b>
Sensing height		120 mm <b>4.724 in</b>	200 mm <b>7.874 in</b>	280 mm <b>11.024 in</b>	360 mm <b>14.173 in</b>	440 mm <b>17.323 in</b>	520 mm <b>20.472 in</b>	600 mm <b>23.622 in</b>	760 mm <b>29.921 in</b>	920 mm <b>36.220 in</b>
Sensing range		5 m <b>16.404 ft</b>								
Beam pitch		40 mm <b>1.575 in</b>								
Sensing object		ø60 mm <b>ø2.362 in</b> or more opaque object								
Supply voltage		12 to 24 V DC ±10 % Ripple P-P 10 % or less								
Current consumption		Emitter: 30 mA or less Receiver: 60 mA or less			Emitter: 35 mA or less, Receiver: 90 mA or less				Emitter: 35 mA or less Receiver: 115 mA or less	
Sensing output		NPN open-collector transistor • Maximum sink current: 100 mA • Applied voltage: 30 V DC or less (between sensing output and 0 V) • Residual voltage: 1.6 V or less (at 100 mA sink current)								
Output operation		ON when all beam channels are received / OFF when one or more beam channels are interrupted								
Short-circuit protection		Incorporated								
Self-diagnosis output		NPN open-collector transistor • Maximum sink current: 50 mA • Applied voltage: 30 V DC or less (between self-diagnosis output and 0 V) • Residual voltage: 1.6 V or less (at 50 mA sink current)								
Output operation		OFF when unstable light received condition continues for 5 sec. or more, or the output transistor fails								
Short-circuit protection		Incorporated								
Response time		12 ms or less								
Indicator		Incorporated with the three color indicators on the receiver • Sensing output operation indicator: Red LED (lights up when one or more beam channels are interrupted) • Stable incident beam indicator: Green LED (lights up when all beam channels are received stably) • Unstable incident beam indicator: Yellow LED (lights up when one or more beam channels are received unstably) * When the output transistor fails, the three color indicators blink simultaneously.								
Interference prevention function		Incorporated (Two units of sensors can be mounted close together.)								
Protection		IP65 (IEC)								
Ambient temperature		-10 to +50 °C <b>+14 to +122 °F</b> (No dew condensation or icing allowed), Storage: -10 to +60 °C <b>+14 to +140 °F</b>								
Ambient humidity		35 to 85 % RH, Storage: 35 to 85 % RH								
Ambient illuminance		Incandescent light: 3,500 lx or less at the light-receiving face								
Voltage withstandability		1,000 V AC for one min. between all supply terminals connected together and enclosure								
Insulation resistance		20 MΩ, or more, with 500 V DC megger between all supply terminals connected together and enclosure								
Vibration resistance		10 to 55 Hz frequency, 1.5 mm <b>0.059 in</b> double amplitude in X, Y and Z directions for two hours each								
Shock resistance		100 m/s <sup>2</sup> acceleration (10 G approx.) in X, Y and Z directions three times each								
Emitting element		Infrared LED (synchronized scanning system)								
Material		Protection enclosure: Aluminum, Unit case: ABS, Front cover: Acrylic, Lens: Acrylic								
Cable		0.5 mm <sup>2</sup> 4-core (emitter: 3-core) cable, 0.5 m <b>1.640 ft</b> long, with a round connector at the end * Use together with the optional mating cable								
Cable extension		Extension up to total 100 m <b>328.084 ft</b> is possible, for both emitter and receiver, with 0.5 mm <sup>2</sup> , or more, cable. (However, the interference prevention wire can extend up to 20 m <b>65.617 ft</b> between two emitters.)								
Net weight (Total of emitter and receiver)		400 g approx.	500 g approx.	630 g approx.	770 g approx.	890 g approx.	1,020 g approx.	1,150 g approx.	1,400 g approx.	1,660 g approx.
With spatter protection hood		500 g approx.	630 g approx.	800 g approx.	990 g approx.	1,150 g approx.	1,330 g approx.	1,500 g approx.	1,840 g approx.	2,190 g approx.
Accessories		<b>MS-NA40-1</b> (Sensor mounting bracket): 1 set for emitter and receiver, Adjusting screwdriver: 1 pc.								

Note: Where measurement conditions have not been specified precisely, the conditions used were an ambient temperature of +23 °C **+73.4 °F**.

**I/O CIRCUIT DIAGRAMS**

**I/O circuit diagrams**

**Emitter**

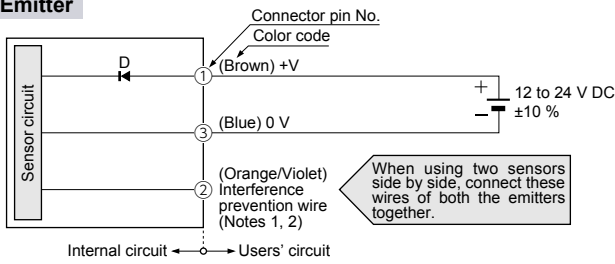

Symbols ... D: Reverse supply polarity protection diode

- Notes: 1) If the interference prevention wires (orange/violet) are not used, please insulate them.  
 2) Never connect the emitter's interference prevention wire (orange/violet) to the receiver's self-diagnosis output (orange). This can cause damage.

**Connector pin position**

**Emitter**

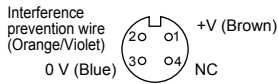

**Receiver**

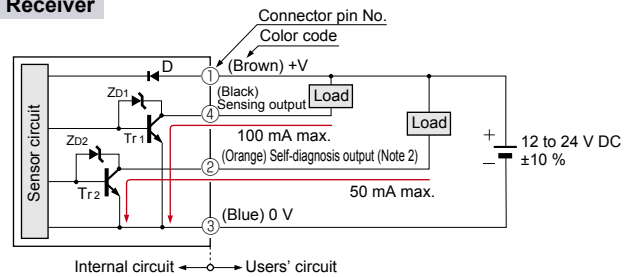

Symbols ... D: Reverse supply polarity protection diode  
 Zd1, Zd2: Surge absorption zener diode  
 Tr1, Tr2 : NPN output transistor

**Receiver**

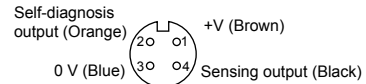

**PRECAUTIONS FOR PROPER USE**

Refer to p.1552~ for general precautions.

- Never use this product as a sensing device for personnel protection.
- For sensing devices to be used as safety devices for press machines or for personnel protection, use products which meet standards, such as OSHA, ANSI or IEC etc., for personnel protection applicable in each region or country.
- If this product is used as a sensing device for personnel protection, death or serious body injury could result.
- For a product which meets safety standards, use the safety light curtains. (p.455~)

**Setting of interference prevention function**

- Make sure that the power supply is off while operating the frequency selection switch. If the switch is operated while the power is on, the sensor may go into the operation stopped state. However, to restart the sensor, turn the power off and on again.
- The frequency selection switch should not be set to the positions other than those specified below.
- When the sensor A breaks down due to any reason, the sensor B goes into the operation stopped state. In order to check the operation of the sensor B, set the frequency selection switch to '1'. Note that when only the sensor B breaks down, the sensor A keeps operation correctly.

- When the interference prevention function is not used (when one set of sensor is used) make sure that the frequency selection switch in both the emitter and receiver is set to '1'. If the switch is set to other than that, the sensor may not operate properly.

**When using one set of sensor**

Frequency selection switches	
Emitter	Receiver

Set the switches of both the emitter and the receiver at '1'. The sensor does not function normally at other settings.

**When using two sets of sensor**

- Up to two sets of sensors can be mounted close together by using the interference prevention function in the following procedure.

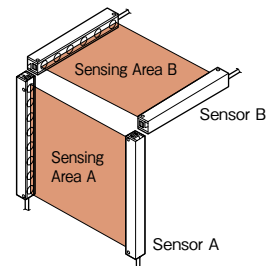

- ① Set the frequency selection switch. Firstly, push up the front cover while pressing the cover stopper towards the arrow shown in the right figure.
- ② Turn the frequency selection switch with the accessory adjusting screwdriver to select the frequency.

	Frequency selection switches	
	Emitter	Receiver
Sensor A		
Sensor B		

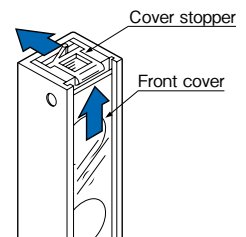

Set the switches of both the emitter and the receiver of Sensor A at '1', and both switches of Sensor B at '2'. The sensors do not function normally at other settings.

- ③ Connect the interference prevention wire (INTER LOCK) of Sensor A and B.

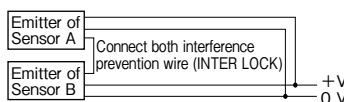

- Connect both the 0 V wires in common.
- +V wires need not be connected in common.

Note: Total of wire length between Sensor A and B is 20 m **65.617 ft** max. (Total of wire length of interference prevention wire and 0 V is 20 m **65.617 ft** max.)

FIBER SENSORS

LASER SENSORS

PHOTO-ELECTRIC SENSORS

MICRO PHOTO-ELECTRIC SENSORS

AREA SENSORS

SAFETY LIGHT CURTAINS / SAFETY COMPONENTS

PRESSURE / FLOW SENSORS

INDUCTIVE PROXIMITY SENSORS

PARTICULAR USE SENSORS

SENSOR OPTIONS

SIMPLE WIRE-SAVING UNITS

WIRE-SAVING SYSTEMS

MEASUREMENT SENSORS

STATIC CONTROL DEVICES

LASER MARKERS

PLC

HUMAN MACHINE INTERFACES

ENERGY MANAGEMENT SOLUTIONS

FA COMPONENTS

MACHINE VISION SYSTEMS

UV CURING SYSTEMS

Selection Guide

Slim Body

Picking

Other Products

**NA40**

**DIMENSIONS (Unit: mm in)**

The CAD data can be downloaded from our website.

**NA40-□**

Sensor

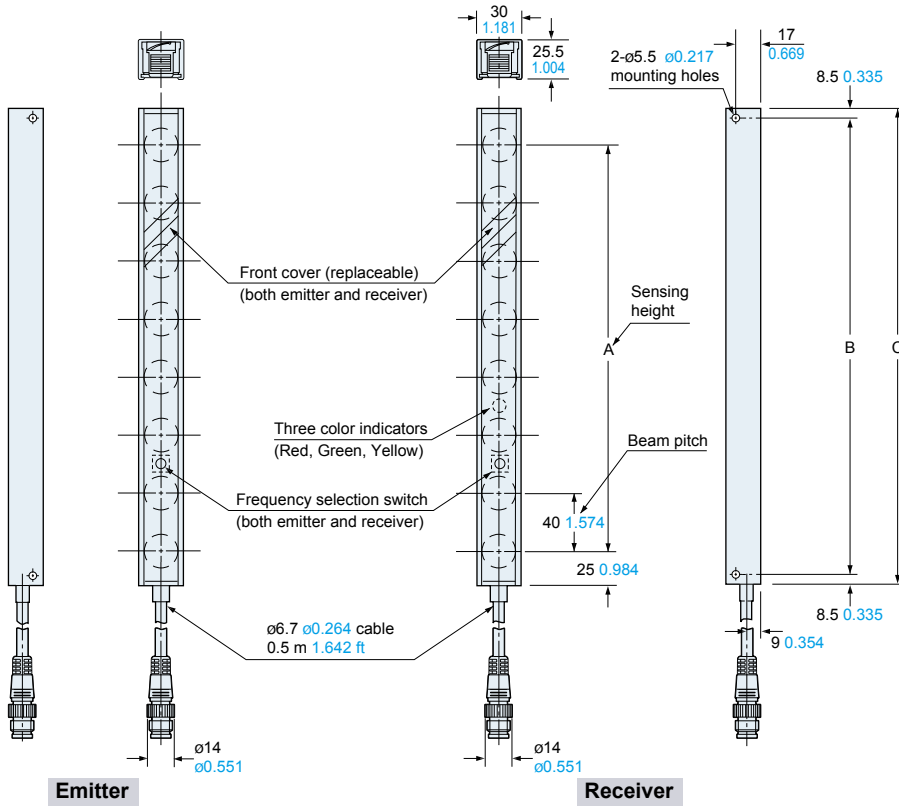

Model No.	A	B	C
<b>NA40-4</b>	120 4.724	163 6.417	180 7.087
<b>NA40-6</b>	200 7.874	233 9.173	250 9.843
<b>NA40-8</b>	280 11.024	313 12.323	330 12.992
<b>NA40-10</b>	360 14.173	393 15.472	410 16.142
<b>NA40-12</b>	440 17.323	473 18.622	490 19.291
<b>NA40-14</b>	520 20.472	553 21.772	570 22.441
<b>NA40-16</b>	600 23.622	633 24.921	650 25.591
<b>NA40-20</b>	760 29.921	793 31.220	810 31.890
<b>NA40-24</b>	920 36.220	953 37.520	970 38.189

**NA40-□-H**

Sensor

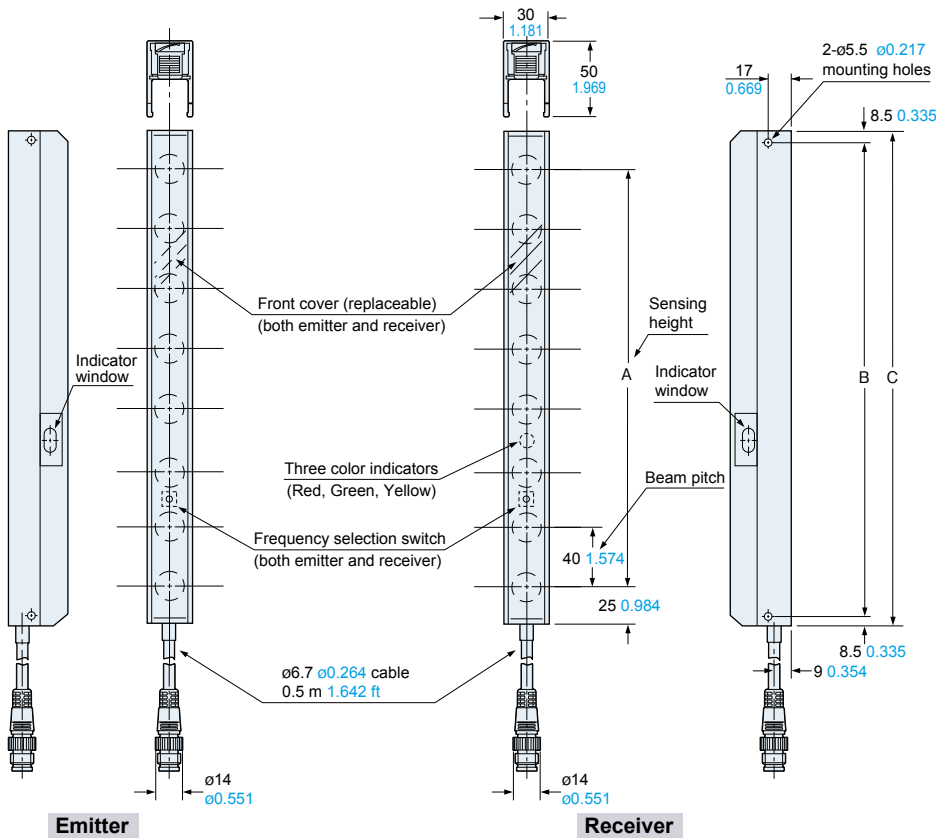

Model No.	A	B	C
<b>NA40-4-H</b>	120 4.724	163 6.417	180 7.087
<b>NA40-6-H</b>	200 7.874	233 9.173	250 9.843
<b>NA40-8-H</b>	280 11.024	313 12.323	330 12.992
<b>NA40-10-H</b>	360 14.173	393 15.472	410 16.142
<b>NA40-12-H</b>	440 17.323	473 18.622	490 19.291
<b>NA40-14-H</b>	520 20.472	553 21.772	570 22.441
<b>NA40-16-H</b>	600 23.622	633 24.921	650 25.591
<b>NA40-20-H</b>	760 29.921	793 31.220	810 31.890
<b>NA40-24-H</b>	920 36.220	953 37.520	970 38.189

- FIBER SENSORS
- LASER SENSORS
- PHOTO-ELECTRIC SENSORS
- MICRO PHOTO-ELECTRIC SENSORS
- AREA SENSORS
- SAFETY LIGHT CURTAINS / SAFETY COMPONENTS
- PRESSURE / FLOW SENSORS
- INDUCTIVE PROXIMITY SENSORS
- PARTICULAR USE SENSORS
- SENSOR OPTIONS
- SIMPLE WIRE-SAVING UNITS
- WIRE-SAVING SYSTEMS
- MEASUREMENT SENSORS
- STATIC CONTROL DEVICES
- LASER MARKERS
- PLC
- HUMAN MACHINE INTERFACES
- ENERGY MANAGEMENT SOLUTIONS
- FA COMPONENTS
- MACHINE VISION SYSTEMS
- UV CURING SYSTEMS

- Selection Guide
- Slim Body
- Picking
- Other Products
- NA40**

**DIMENSIONS (Unit: mm in)**

The CAD data can be downloaded from our website.

**MS-NA40-1**

Sensor mounting bracket (Accessory)

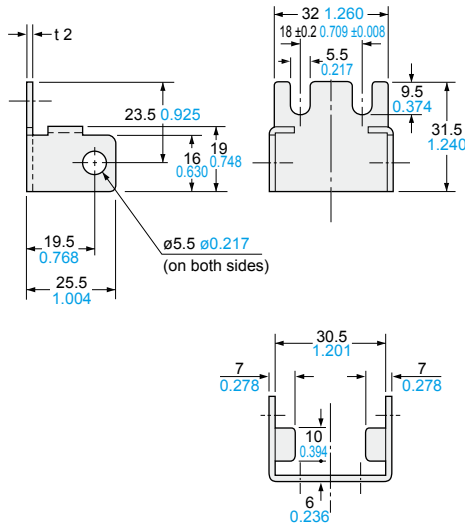

Material: Cold rolled carbon steel (SPCC)  
(Uni-chrome plated)

Four bracket set  
(4 pcs. each of M5 (length 40 mm 1.575 in)  
truss head screws, nuts and spring  
washers are attached.)

**Assembly dimensions**

Mounting drawing with NA40-□.  
The assembly for the spatter protection hood type  
(NA40-□-H) is similar.

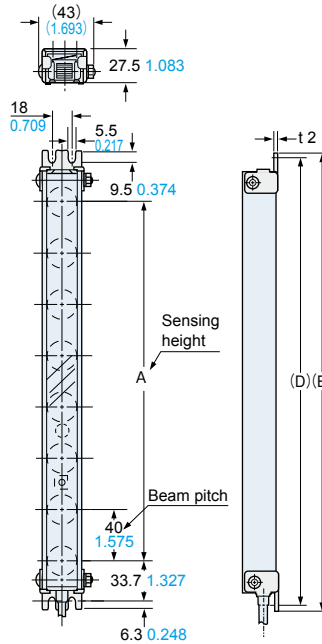

Model No.	A	D	E
NA40-4(-H)	120 4.724	200 7.874	210 8.268
NA40-6(-H)	200 7.874	270 10.630	280 11.024
NA40-8(-H)	280 11.024	350 13.780	360 14.173
NA40-10(-H)	360 14.173	430 16.929	440 17.323
NA40-12(-H)	440 17.323	510 20.079	520 20.472
NA40-14(-H)	520 20.472	590 23.228	600 23.622
NA40-16(-H)	600 23.622	670 26.378	680 26.772
NA40-20(-H)	760 29.921	830 32.677	840 33.071
NA40-24(-H)	920 36.220	990 38.976	1,000 39.370

**SF-IND**

Large indicator for area sensor (Optional)

**Assembly dimensions**

Mounting drawing with NA40-□ on which a sensor  
mounting bracket is attached.  
The assembly for the spatter protection hood type  
(NA40-□-H) is similar.

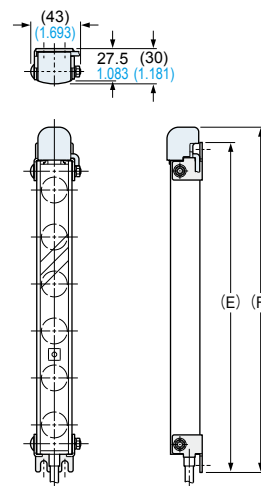
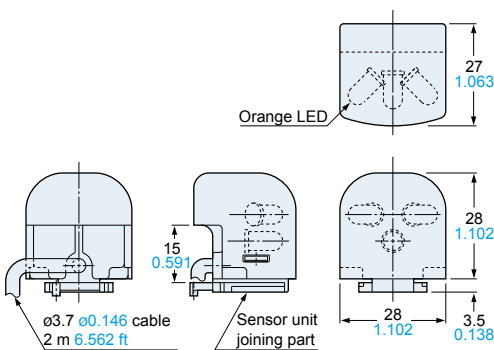

Model No.	E	F
NA40-4(-H)	210 8.268	223 8.780
NA40-6(-H)	280 11.024	293 11.535
NA40-8(-H)	360 14.173	373 14.685
NA40-10(-H)	440 17.323	453 17.835
NA40-12(-H)	520 20.472	533 20.984
NA40-14(-H)	600 23.622	613 24.134
NA40-16(-H)	680 26.772	693 27.283
NA40-20(-H)	840 33.071	853 33.583
NA40-24(-H)	1,000 39.370	1,013 39.882

FIBER SENSORS  
LASER SENSORS  
PHOTO-ELECTRIC SENSORS  
MICRO PHOTO-ELECTRIC SENSORS  
AREA SENSORS  
SAFETY LIGHT CURTAINS / SAFETY COMPONENTS  
PRESSURE / FLOW SENSORS  
INDUCTIVE PROXIMITY SENSORS  
PARTICULAR USE SENSORS  
SENSOR OPTIONS  
SIMPLE WIRE-SAVING UNITS  
WIRE-SAVING SYSTEMS  
MEASURE-MENT SENSORS  
STATIC CONTROL DEVICES  
LASER MARKERS  
PLC  
HUMAN MACHINE INTERFACES  
ENERGY MANAGEMENT SOLUTIONS  
FA COMPONENTS  
MACHINE VISION SYSTEMS  
UV CURING SYSTEMS

Selection Guide  
Slim Body  
Picking  
Other Products

**NA40**