Inductive proximity sensors

XS range

Catalogue



Simply easy!™

Inductive proximity sensors

XS range

Selection guide *page 2*

- General *page 12*
- Flush mountability using teach mode:
Simplicity through innovation *page 70*

XS range, general purpose

- Cylindrical type
 - Standard range, flush mountable *page 22*
 - Increased range, flush mountable *page 32*
 - Increased range, non flush mountable *page 40*
- Block type
 - Standard range, flush mountable *page 46*
- Cubic type
 - 40 x 40 x 70 mm format, flush or non flush mountable *page 50*
 - 40 x 40 x 117 mm format, flush or non flush mountable *page 52*
- Multivoltage sensors with short-circuit protection *page 54*
- Sensors with 2 complementary outputs
 - Solid-state PNP or NPN, NO + NC outputs *page 56*
 - Solid-state PNP + NPN, NO or NC programmable outputs *page 62*
- Plastic case sensors *page 64*
(for chemical processing, marine applications)
- Quasi flush mountable sensors, increased range *page 66*
- Miniature sensors *page 68*

XS range, Application

- Adjustable range sensors *page 72*
- Sensors for rotation monitoring *page 77*
- Sensors with analogue output *page 81*
- Sensors for food/beverage and pharmaceutical applications
 - Cubic, plastic *page 88*
 - Cylindrical, stainless steel *pages 92 and 94*
 - Cylindrical, plastic *pages 96 and 98*
 - Cylindrical, stainless steel, for harsh industrial environments *page 100*
- Sensors for assembly, packaging and light material handling applications
 - 12 x 26 x 40 mm format *page 102*
 - 80 x 80 x 40 mm format *page 106*
- Sensors for welding machine applications *pages 108 to 110*
- Selective detection of ferrous and non ferrous materials *page 112*
- Accessories *page 118*
- Detection curves *page 122*
- Substitution table *page 126*
- **Product reference index** *page 132*

Inductive proximity sensors

XS range
General purpose

Cylindrical type

Standard range

Flush mountable

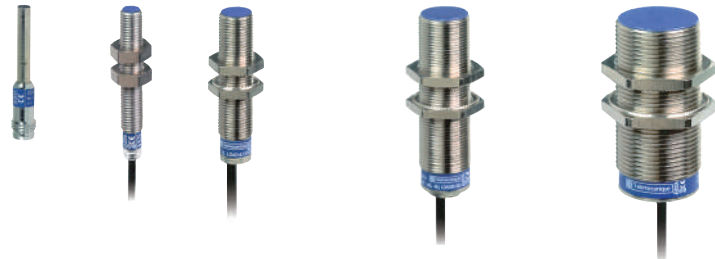

Sensing distance Sn (mm)		1.5	2	5	10	
Diameter		Ø 6.5 plain and M8	M12	M18	M30	
Short case	Supply	Page 22				
	3-wire --- (PNP/NPN)	Page 26				
	2-wire ---					
Long case	Supply	Page 23				
	3-wire --- (PNP/NPN)	Page 27				
	2-wire ---	-				
	2-wire ~	Page 30				
Function	NO	•	•	•	•	
	NC	•	•	•	•	
Connection	Pre-cabled (L = 2 m) (1)	•	•	•	•	
	M8 connector, 3-pin (3-wire ---)	•	-	-	-	
	M12 connector	•	•	•	•	
	1/2"-20UNF connector	-	•	•	•	
	Remote connector	Remote connectors available: M8, M12, M18, screw terminal, 7/8", DIN: please consult our Customer Care Centre				
Degree of protection		IP 65 and IP 67, IP 68 for pre-cabled version, IP 69K for diameters 12 to 30				
Special temperatures	-40 °C, +70 °C	Add the suffix TF to the end of the reference (2)				
	-25 °C, +85 °C	Add the suffix TT to the end of the reference (2)				
Type reference		XS506	XS508	XS512	XS518	XS530
Pages		22 to 31				

(1) Also available in lengths of 5 and 10 m, depending on model
(2) Product availability depending on model: please consult our Customer Care Centre.

Increased range

Flush mountable Non flush mountable



Sensing distance Sn (mm)		2.5	4	8	15	4	7	8	12	16	22	30	
Diameter		Ø 6.5 plain and M8	M12	M18	M30	M8	M12		M18		M30		
Pages 32 and 33		-				-	-	Page 42	-	Page 42	-	-	
Page 36		-				-	-	-	-	-	-	-	
Page 34		-				Page 40	Page 40	-	Page 40	-	-	Page 40	
Page 36		-				-	-	-	-	-	-	-	
-		Page 38				-	-	-	Page 44	-	Page 44	-	
Function	NO	•	•	•	•	•	•	•	•	•	•	•	
	NC	•	•	•	•	•	•	•	•	•	•	•	
Connection	Pre-cabled (L = 2 m) (1)	•	•	•	•	•	•	•	•	•	•	•	
	M8 connector, 3-pin (3-wire ---)	•	-	-	-	•	-	-	-	-	-	-	
	M12 connector	•	•	•	•	•	•	•	•	•	•	•	
	1/2"-20UNF connector	-	•	•	•	-	•	•	•	•	•	•	
	Remote connector	Remote connectors available: M8, M12, M18, screw terminal, 7/8", DIN: please consult our Customer Care Centre											
Degree of protection		IP 65 and IP 67, IP 68 for pre-cabled version, IP 69K for diameters 12 to 30					IP 65 and IP 67, IP 68 for pre-cabled version, IP 69K for diameters 12 to 30						
Special temperatures	-40 °C, +70 °C	Add the suffix TF to the end of the reference (2)											
	-25 °C, +85 °C	Add the suffix TT to the end of the reference (2)											
Type reference		XS106	XS112	XS118	XS130	XS608	XS612	XS212	XS618	XS218	XS630		
		XS606	XS612	XS618	XS630								
		XS108											
		XS608											
Pages		32 to 39					40 to 45						

Inductive proximity sensors

XS range
General purpose

Block type

Standard range

Flush mountable



Sensing distance Sn (mm)	2.5	5	10	15	40
Dimensions (W x H x D)	8 x 22 x 8	15 x 32 x 8	26 x 26 x 13	40 x 40 x 15	80 x 80 x 26
Supply	3-wire --- (PNP/NPN)	Page 46	Page 46	Page 48	Page 48
	2-wire ---	Page 46	Page 46	Page 48	Page 48
	~	-	-	-	-
Function	NO	•	•	•	•
	NC	•	•	•	•
	NO + NC	-	-	-	-
	NO/NC	-	-	-	-
Connection	Pre-cabled (L = 2 m) (1)	•	•	•	•
	M8 connector, 3-pin (3-wire ---)	-	-	•	-
	M12 connector	-	-	-	•
	1/2"-20UNF connector	-	-	-	-
	Screw terminals	-	-	-	-
	Remote connector	•	•	-	-
	M8	-	-	•	-
	M12	-	-	•	-
	1/2"-20 UNF	-	-	-	-
	Other remote connectors available	M18, screw terminal, 7/8", DIN: please consult our Customer Care Centre			
Degree of protection	IP 67	IP 67, double insulation ☐ or IP 68, double insulation ☐, depending on model			
Special temperatures	-40 °C, +70 °C	Add the suffix TF to the end of the reference (2)			
	-25 °C, +85 °C	Add the suffix TT to the end of the reference (2)			
Type reference	XS7J	XS7F	XS7E	XS7C	XS7D
Pages	46	48			

(1) Also available in lengths of 5 and 10 m, depending on model.
(2) Product availability depending on model: please consult our Customer Care Centre.

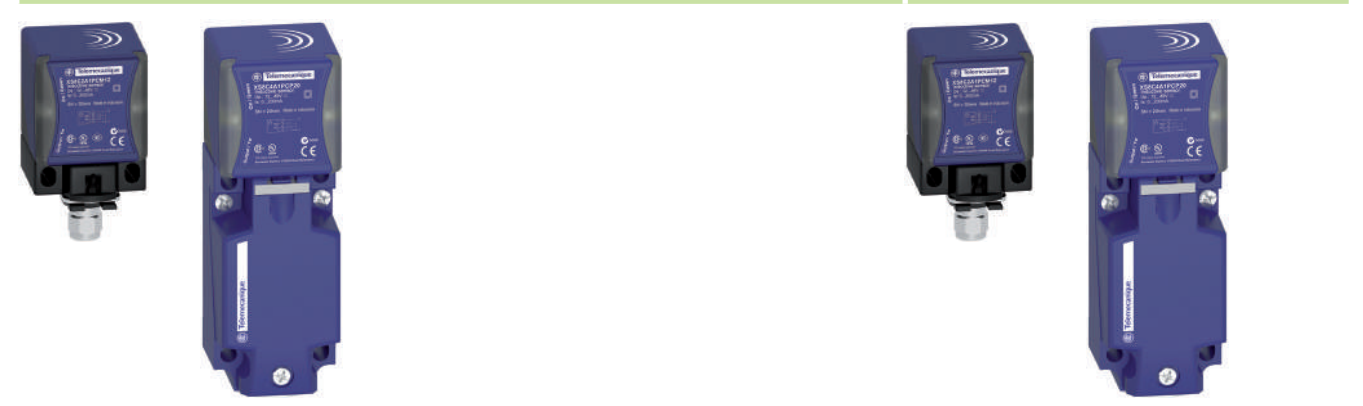

Standard and increased ranges







Flush mountable	20	40
15		
40 x 40 x 70 and 40 x 40 x 117		
Pages 50 and 52		
Pages 50 and 52		
Pages 50 and 52		
•	•	•
•	•	•
-	•	•
•	•	•
-	-	-
-	-	-
•	•	•
•	•	•
•	•	•
-	-	-
-	-	-
-	-	-
-	-	-
-	-	-
IP 65, IP 67 and IP 69K		
Add the suffix TF to the end of the reference (2)		
Add the suffix TT to the end of the reference (2)		
XS7C2, XS7C4, XS8C2 and XS8C4		
50 and 52		

Inductive proximity sensors

XS range
General purpose

Sensor type: flush and non flush mountable		Multivoltage sensors	Sensors with 2 complementary outputs	
		With short-circuit protection	Solid-state PNP or NPN NO + NC outputs	Solid-state PNP + NPN, NO or NC programmable outputs
				
Sensing distance Sn (mm)	Flush mountable Non flush mountable	2 ... 10 4 ... 15	1.5 ... 15 2.5 ... 15	2 ... 10 4 ... 15
Diameter		Threaded: M12, M18, M30	Plain: Ø 6.5 Threaded: M8, M12, M18, M30	Threaded: M12, M18, M30
Case material		Nickel plated brass	Nickel plated brass or stainless steel or plastic	Nickel plated brass or plastic
Supply	⋮ ~ ~	– – •	• – –	• – –
Function	NO NC NO + NC NO/NC	• • – –	– – • –	– – – • programmable
Connection	Pre-cabled (L = 2 m) (1) M8 connector, 3-pin (3-wire ⋮) M12 connector 1/2"-20UNF connector Remote connector	• – – •	• – • –	• – • –
		Remote connectors available: M8, M12, M18, screw terminal, 7/8", DIN: please consult our Customer Care Centre		
Degree of protection		IP 67, IP 68 or IP 69K depending on model		
Special temperatures	-40 °C, +70 °C -25 °C, +85 °C	Add the suffix TF to the end of the reference (2) Add the suffix TT to the end of the reference (2)		
Type reference		XS1M XS2M	XS1●●●C410 XS4P●●●C410 XS1●●B3PC●	XS1M●●KP340 XS2M●●KP340 XS4P●●KP340
Pages		54	56 and 60	62

(1) Also available in lengths of 5 and 10 m, depending on model.
(2) Product availability depending on model: please consult our Customer Care Centre.

Plastic case sensors	Basic sensors	Almost flush mountable sensors	Miniature sensors
For chemical processing, marine applications	For repetitive machines		For robotic, transfer machine, assembly line applications
			
			
– 2.5 ... 15	1.5 ... 10 2.5 ... 15	2.5 ... 15 –	– 2.5 ... 20
Threaded: M8, M12, M18, M30	Threaded: M8, M12, M18, M30	Threaded: M8, M12, M18, M30	Plain: Ø 4 Threaded: M5
Plastic	Nickel plated brass	Nickel plated brass	Nickel plated brass or stainless steel
• – •	• – –	• – –	• – –
– • • – –	• • – – –	• • – – –	• • – – –
• – – •	• • • – –	• • • – –	• • • – –
Remote connectors available: M8, M12, M18, screw terminal, 7/8", DIN: please consult our Customer Care Centre			
IP 67 or IP 68 depending on model	IP 67	IP 65 or IP 67	IP 67 or IP 68 IP 69K depending on model
Add the suffix TF to the end of the reference (2) Add the suffix TT to the end of the reference (2)			
XS4P	XS1●●BL● XS2●●BL●	XS1●●BH●	XS1N●●349
			XS1L XS2L XS1N
64	Please refer to our catalogue Inductive proximity sensors XS range. Basics line	66	68

Applications

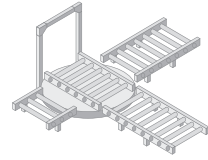

Conveying

Sensor type: flush and non flush mountable

Adjustable range sensors

Developed in accordance with the needs expressed by our customers, these sensors provide a complete solution for specific application functions: rotation monitoring, selective detection, analogue control, etc.



Sensing dist.	Flush mountable	3...11 (1)	15	25	60
Sn (mm)	Non flush mountable	5...18 (1)	–	–	–
Form	Cylindrical	M12 x 54 M18 x 67 M30 x 71	–	–	–
	Block (W x H x D) dimensions in mm	–	26 x 26 x 13	40 x 40 x 15	80 x 80 x 26
Case material		Nickel plated brass	PBT	PBT	PBT
Supply		•	•	•	•
		–	–	–	–
		–	•	•	•
Function		•	•	•	•
	NO	•	•	•	•
	NC	•	•	•	•
	NO + NC	–	–	–	–
	NO/NC	–	–	–	–
Connection		–	•	•	•
	Pre-cabled (L = 2 m) (2)	–	•	•	•
	M8 connector, 3-pin (--- 3-wire)	–	•	•	–
	M12 connector	–	–	–	•
	1/2"-20UNF connector	–	–	–	•
	Remote connector	•	•	•	•
	Screw terminals	–	–	–	–
Degree of protection		IP 67, double insulation ☐	IP 67, double insulation ☐ or IP 68, double insulation ☐, depending on model.		
Special temperatures		Add the suffix TF to the end of the reference (3) Add the suffix TT to the end of the reference (3)			
Type reference		XS612B2 XS618 B2 XS630 B2	XS8E	XS8C	XS8D
Pages		72	74		

(1) Depending on model.
(2) Also available in lengths of 5 and 10 m, depending on model.
(3) Product availability depending on model: please consult our Customer Care Centre.

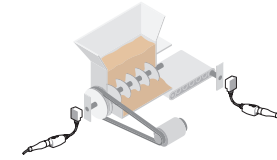

Detection of underspeed, shaft overload

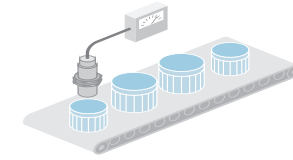

Position, displacement and deformation control/monitoring

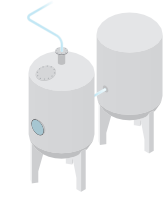

Machine with stainless steel housing

Sensors for rotation monitoring

Sensors with analogue output
0 ... 10 V or 4 ... 20 mA

Sensors for food/beverage and pharmaceutical applications
Cylindrical, stainless steel 316 L Cylindrical, plastic



10	10...15 (1)	0.2...10 (1)	5...40 (1)	–	–	6, 10 or 20 (1)	–	–
10	10...15 (1)	0.4...15 (1)	5...40 (1)	2...25	2...25	10, 20 or 40 (1)	7...22 (1)	7...22 (1)
M30 x 81	–	Threaded: M12, M18, M30	–	–	–	Threaded: M12, M18, M30	Plain: Ø 18 Threaded: M12, M18, M30	Threaded: M12, M18, M30
–	26 x 26 x 13 40 x 40 x 15	–	32 x 15 x 8 26 x 26 x 13 40 x 40 x 15 80 x 80 x 26	40 x 40 x 70	40 x 40 x 117	–	–	–
Metal	PBT	Metal or plastic	PBT	PBT	PBT	Stainless steel, 316 L	Stainless steel, 316 L	Plastic, PPS
•	•	•	•	•	•	•	•	•
–	–	–	–	–	–	–	–	–
•	•	–	–	–	–	–	•	•
–	–	–	–	–	–	•	•	•
•	•	–	–	–	–	–	–	–
–	–	–	–	–	–	–	–	–
–	–	–	•	•	–	–	•	•
–	–	–	–	–	–	–	–	–
–	–	–	•	•	–	–	•	•
–	•	–	–	–	–	–	–	–
–	–	–	–	–	•	–	–	–
IP 67	IP 67, double insulation ☐	IP 67	IP 67 or IP 68 (pre-cabled version)	IP 65, IP 67 IP 69K	IP 65, IP 67 IP 69K	IP 68, IP 69K	IP 68 (pre-cabled version), double insulation ☐ IP 69K conforming to DIN 40050	
Add the suffix TF to the end of the reference (3) Add the suffix TT to the end of the reference (3)								
XSAV	XS9●11R	XS1M●●●AB1 XS4P●●AB1	XS9●●●A	XS9C2	XS9C4	XS9●●S●	XS2●●SA	XS2●●AA
77	79	81	85 and 87	88	88	90	92 and 94	96 and 98

Inductive proximity sensors

XS range
Applications

Applications

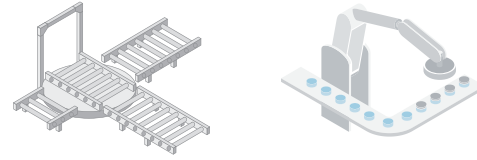

Conveying

Sensor type: flush and non flush mountable

Sensors for conveying and material handling applications

Developed in accordance with the needs expressed by our customers, these sensors provide a complete solution for specific application functions: rotation monitoring, selective detection, analogue control, etc.



Sensing dist.	Flush mountable
Sn (mm)	Non flush mountable
Form	Cylindrical
Block (W x H x D) dimensions in mm	
Case material	
Supply	<ul style="list-style-type: none"> • ~ λ
Function	<ul style="list-style-type: none"> NO NC NO + NC NO/NC
Connection	<ul style="list-style-type: none"> Pre-cabled (L = 2 m) (2) M8 connector, 3-pin (--- 3-wire) M12 connector 1/2"-20UNF connector Remote connector Screw terminals
Degree of protection	
Special temperatures	<ul style="list-style-type: none"> -40 °C, +70 °C -25 °C, +85 °C
Type reference	
Pages	

	3, 6, 10 or 20 (1)	2	50
	6, 10, 20 or 40 (1)	4	42
Threaded: M8, M12, M18, M30	-	-	-
Block (W x H x D) dimensions in mm	12 x 40 x 26	80 x 80 x 40	
Case material	Stainless steel 303	Plastic	Plastic
Supply	•	•	•
Function	•	•	•
Connection	•	•	•
Degree of protection	IP 67 and IP 69K	IP 67	IP 67, double insulation
Special temperatures	Add the suffix TF to the end of the reference (3)		
Type reference	XS9●●R●	XS7G XS8G	XS7D
Pages	100	102	106

(1) Depending on model.
(2) Also available in lengths of 5 and 10 m, depending on model.
(3) Product availability depending on model: please consult our Customer Care Centre.

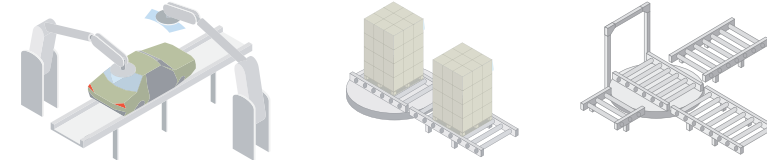

Robotics

Assembly machines, conveyor systems, material handling

Sensors for welding machine applications

Factor 1 (Fe/Nfe) sensors for ferrous and non ferrous materials

Selective detection sensors for ferrous materials only or non ferrous materials only



	6 or 10 (1)	5, 10 or 15 (1)	20	20	5
Threaded: M12, M18	-	Threaded: M18, M30	-	-	Threaded: M18
Block (W x H x D) dimensions in mm	-	-	40 x 40 x 70	40 x 40 x 117	-
Case material	Stainless steel 303	Metal	PBT	PBT	Metal
Supply	•	•	•	•	•
Function	•	•	•	•	•
Connection	•	•	•	•	•
Degree of protection	IP 68 and IP 69K	IP 68	IP 65, IP 67 and IP 69K		IP 68
Special temperatures	Add the suffix TF to the end of the reference (3)				
Type reference	XS9●●RW XSLC	XS1M●●●KP	XS9C2	XS9C4	XS1M18PA
Pages	108 and 110	112	114	114	116

	6 or 10 (1)	5, 10 or 15 (1)	20	20	5
Threaded: M12, M18	-	Threaded: M18, M30	-	-	Threaded: M18
Block (W x H x D) dimensions in mm	-	-	40 x 40 x 70	40 x 40 x 117	-
Case material	Stainless steel 303	Metal	PBT	PBT	Metal
Supply	•	•	•	•	•
Function	•	•	•	•	•
Connection	•	•	•	•	•
Degree of protection	IP 68 and IP 69K	IP 68	IP 65, IP 67 and IP 69K		IP 68
Special temperatures	Add the suffix TF to the end of the reference (3)				
Type reference	XS9●●RW XSLC	XS1M●●●KP	XS9C2	XS9C4	XS1M18PA
Pages	108 and 110	112	114	114	116

Standards and certifications

Parameters related to the environment

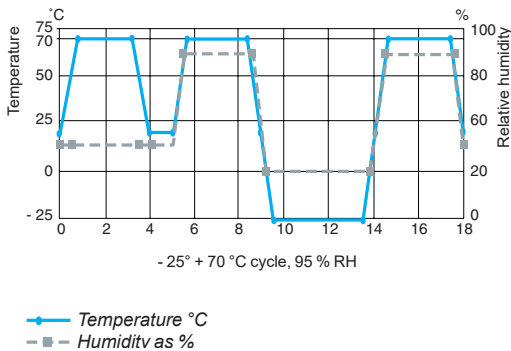

Recommendations

The sensors detailed in this catalogue are designed for use in standard industrial applications relating to presence detection. These sensors do not incorporate the required redundant electrical circuit enabling their usage in safety applications. For safety applications, please consult our website: www.tesensors.com

Quality control

Our inductive proximity sensors are subject to special precautions in order to guarantee their reliability in the most arduous industrial environments.

- **Qualification**
 - The product characteristics stated in this catalogue are subject to a **qualification procedure** carried out in our laboratories.
 - In particular, the products are subjected to **climatic cycle** tests for 3000 hours whilst powered-up to verify their ability to maintain their characteristics over time.
- **Production**
 - The electrical characteristics and sensing distances at both ambient temperature and extreme temperatures are 100% checked.
 - Products are randomly selected during the course of production and subjected to **monitoring tests** relating to all their qualified characteristics.
- **Customer returns**

If, in spite of all these precautions, defective products are returned to us, they are subject to **systematic analysis** and **corrective actions** are implemented to eliminate the risks of the fault recurring.

Conformity to standards

All Telemecanique Sensors brand inductive proximity sensors conform to and are tested in accordance with the recommendations of standard IEC 60947-5-2.

Mechanical shock resistance

The sensors are tested in accordance with standard IEC 60068-2-27, 50 gn, duration 11 ms.

Vibration resistance

The sensors are tested in accordance with standard IEC 60068-2-6, amplitude ± 2 mm, $f = 10 \dots 55$ Hz, 25 gn at 55 Hz.

Resistance to the environment

- Please refer to the characteristics pages for the various sensors.
- **IP 67:** protection against the effects of immersion.
 - Test conforming to IEC 60529: sensor immersed for 30 minutes in 1 m of water. No deterioration in either operating or insulation characteristics is permitted.
- **IP 68:** protection against prolonged immersion.
 - Sensor immersed for 336 hours in 40 metres of water at 50 °C. No deterioration in either operating or insulation characteristics is permitted. Telemecanique Sensors with an IP 68 degree of protection are ideal for use in the most arduous conditions, such as machine tools, automatic car washers.
- **IP 69K:** protection against the effects of high pressure cleaning. Adherence to standard DIN 40050 which stipulates that the product must withstand a water jet at a pressure of 90 bar and temperature of +80 °C for 3 minutes. No deterioration in either operating or insulation characteristics is permitted.

Resistance to electromagnetic interference

- Electrostatic discharges
 - \sim and \approx versions: level 4 immunity (15 kV). **IEC 61000-4-2**
- Radiated electromagnetic fields (electromagnetic waves)
 - \sim , \approx and \approx versions: level 2 (3 V/m) or level 3 (10 V/m) immunity. **IEC 61000-4-3**
- Fast transients (motor start/stop interference)
 - \approx version: level 3 immunity (1 kV).
 - \sim and \approx versions: level 4 immunity (2 kV) except $\varnothing 8$ mm model (level 2). **IEC 61000-4-4**
- Impulse voltage
 - \approx , \sim and \approx versions: level 3 immunity (2.5 kV) except $\varnothing 8$ mm and smaller models (level 1 kV). **IEC 60947-5-2**

Resistance to chemicals in the environment

- Owing to the very wide range of chemicals encountered in industry, it is very difficult to give general guidelines common to all sensors.
 - To ensure lasting efficient operation, it is essential that any chemicals coming into contact with the sensors will not affect their casing and, in doing so, prevent their reliable operation.
 - Cylindrical and flat plastic case sensors offer excellent overall resistance to:
 - chemical products such as salts, aliphatic and aromatic oils, petroleum, acids and diluted bases. For alcohols, ketones and phenols, preliminary tests should be made relating to the nature and concentration of the liquid.
 - food and beverage industry products such as animal or vegetable based products (vegetable oils, animal fat, fruit juice, dairy proteins, etc.).
- In all cases, the materials selected (see product characteristics) provide satisfactory compatibility in most industrial environments (for further information, please consult our Customer Care Centre).

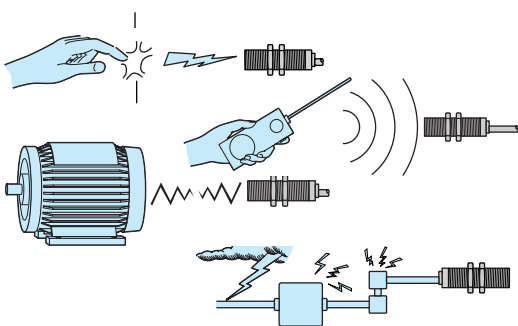

Insulation

Class 2 devices

Electrical insulation conforming to standards IEC 61140 and NF C 20-030 relating to means of protection against electric shock.

Principle of inductive detection

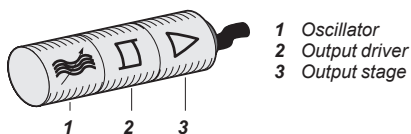

Composition of an inductive proximity sensor

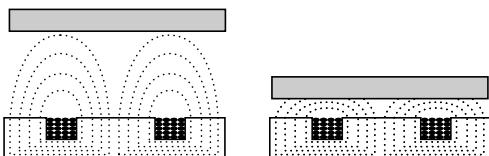

Detection of a metal object

Operating principle

■ An inductive proximity sensor is solely for the detection of metal objects. It basically comprises an oscillator whose windings constitute the sensing face. An alternating magnetic field is generated in front of these windings.

■ When a metal object is placed within the magnetic field generated by the sensor, the resulting currents induced form an additional load and the oscillations cease. This causes the output driver to operate and, depending on the sensor type, a normally open (NO) or normally closed (NC) output signal is produced.

Inductive proximity detection

- Inductive proximity sensors enable the detection, without physical contact, of metal objects.
- Their range of applications is very extensive and includes:
 - monitoring the position of machine parts (cams, end stops, etc.),
 - counting the presence of metal objects, etc.

Advantages of inductive detection

- No physical contact with the object to be detected, thus avoiding wear and enabling detection of fragile objects, freshly painted objects, etc.
- High operating rates. Fast response.
- Excellent resistance to industrial environments (robust products, fully encapsulated in resin).
- Solid-state technology: no moving parts, therefore service life of sensor not related to number of operating cycles.

Flush mountable using teach mode sensors

- The flush mountable sensors using teach mode are suitable for all metal environments (flush mountable or non flush mountable) since they ensure a maximum sensing distance, even if there is a metal background. Precise detection of the position of the object can be obtained using the teach mode. For further information, see page 70.

LED indicator

	Sortie NO	Sortie NC
<p>No object present</p>	LED	LED
Output state		
<p>Object present</p>	LED	LED
Output state		

Output LED

All Telemecanique Sensors inductive proximity sensors incorporate an output state LED indicator.

The flush mountable sensors using teach mode are fitted with a green LED that indicates "Power on" and also assists the user during setting-up (teach mode).

Mounting sensors on a metal support

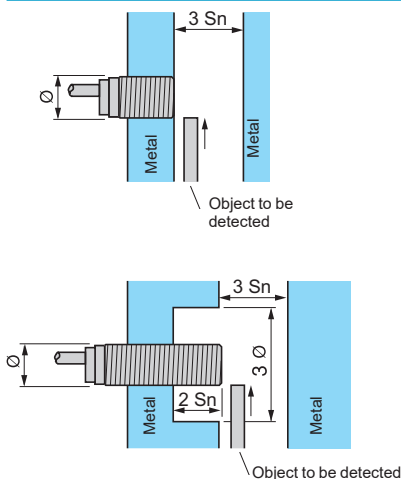

Flush mountable in metal

- No side clearance required.
- All flush mountable sensors using teach mode also enable detection of an object against a metal background. For further information, see pages 70 and 71.

Sensors not suitable for flush mounting in metal

- Side clearance required. Sensing distance greater than that for a standard flush mountable model.
- Flush mountable sensors using teach mode eliminate the need for side clearance. For further information, see pages 70 and 71.

Mounting sensors on a metal support

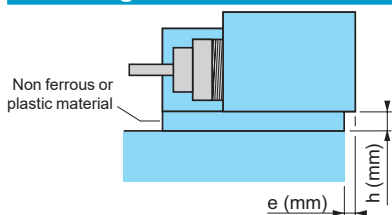

Mounting using fixing clamp

- Standard flush mountable models: $e = 0, h = 0$
- Standard non flush mountable models
- $\varnothing 6.5 / 8 / 12 \text{ mm}$: $e = 0, h = 0$
- $\varnothing 18 \text{ mm}$: if $h = 0, e \geq 5$; $e = 0, h \geq 3$.
- $\varnothing 30 \text{ mm}$: if $h = 0, e \geq 8$; $e = 0, h \geq 4$.
- Flush mountable sensors using teach mode: $e = 0, h = 0$

Mounting distance between sensors

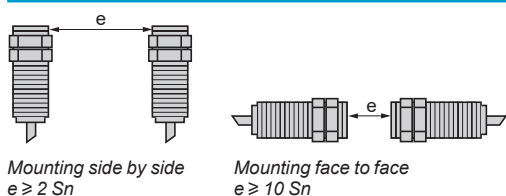

Standard sensors

If 2 standard sensors are mounted too close to each other they are likely to lock in the "detection state" due to interference between their respective oscillating frequencies. To avoid this condition, the minimum mounting distances stated for the sensors should be adhered to or, alternatively, sensors with staggered oscillating frequencies should be used.

Staggered frequency sensors

For applications where the minimum recommended mounting distances for standard sensors cannot be achieved, it is possible to overcome this restraint by using staggered frequency sensors. Please consult our Customer Care Centre. In this case, a staggered frequency sensor is mounted adjacent to or opposite each standard sensor.

Tightening torque for cylindrical type sensors

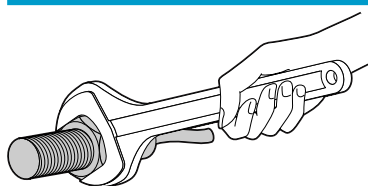

Maximum tightening torque for the various sensor case materials						
	Brass		Stainless steel		Plastic	
	XS1●●B●		XS1●●		XS2●●AA	
	XS2●●B●		XS2●●		XS4P●	
	XS5●●B●		XS5●●B●			
	XS6●●B●		XS6●●B●			
	XSAV●		XS9●●R/S			
Diameter of sensor	Maximum tightening torque					
mm	N.m	lb-in	N.m	lb-in	N.m	lb-in
$\varnothing 5$	1.6	14.16	2	17.70	–	–
$\varnothing 8$	5	44.25	9	79.65	1	8.85
$\varnothing 12$	6	53.10	30	265.52	2	17.70
$\varnothing 18$	15	132.76	50	442.54	5	44.25
$\varnothing 30$	40	354.03	100	885.07	20	177.01

Sensing distance

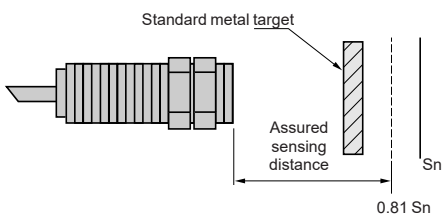
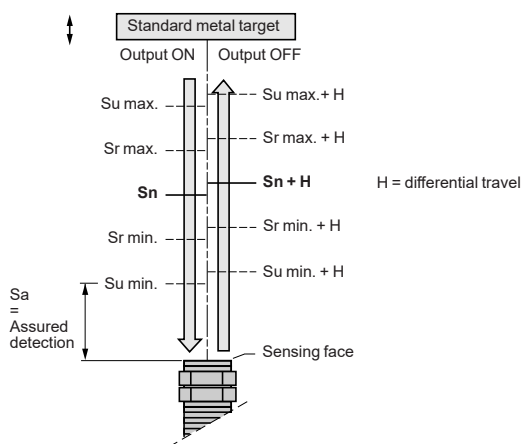

Definitions

In order to ensure that customers can make reliable product comparisons and selection, the standard IEC 60947-5-2 defines various sensing distances, such as:

- Nominal sensing distance (Sn)**
 The rated operating distance for which the sensor is designed. It does not take into account any variations (manufacturing tolerances, temperature, voltage).
- Effective sensing distance (Sr)**
 The effective sensing distance is measured at the rated voltage (U_n) and the rated ambient temperature (T_n). It must be between 90% and 110% of the nominal sensing distance (S_n): $0.9 S_n \leq S_r \leq 1.1 S_n$.
- Usable sensing distance (Su)**
 The usable sensing distance is measured at the limits of the permissible variations in the ambient temperature (T_a) and the supply voltage (U_b). It must be between 90% and 110% of the effective sensing distance: $0.9 S_r \leq S_u \leq 1.1 S_r$.
- Assured operating distance (Sa)**
 This is the operating zone of the sensor. The assured sensing distance is between 0 and 81% of the nominal sensing distance (S_n): $0 \leq S_a \leq 0.9 \times 0.9 \times S_n$.

Standard metal target

The standard IEC 60947-5-2 defines the standard metal target as a square mild steel (Fe 360) plate, 1 mm thick.

The side dimension of the plate is either equal to the diameter of the circle engraved on the sensing face of the sensor or 3 times the nominal sensing distance (S_n).

Terminology

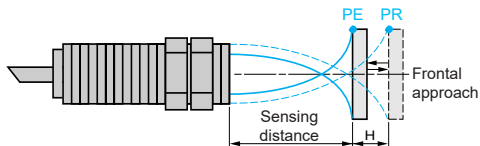

PE = pick-up point, the object is detected
 PR = drop-out point, the object is no longer detected

Differential travel

The differential travel (H), or hysteresis, is the distance between the operating point, as the standard metal target moves towards the sensor, and the release point, as it moves away. This hysteresis is essential for the stable operation of the sensor.

Repeat accuracy

The repeat accuracy (R) is the repeatability of the sensing distance between successive operations. Readings are taken over a period of time whilst the sensor is subjected to voltage and temperature variations: 8 hours, 10 to 30 °C, $U_n \pm 5\%$.

It is expressed as a percentage of the effective sensing distance S_r .

For all XS sensors, the repeat accuracy is 3 %.

Detection zone and precision adjustment zone

- Flush mountable sensors using teach mode, due to adjustment of sensitivity whilst teaching, enable the position of an object to be detected as it approaches from the front or side. The teach mode can be used when the object is located in the zone known as the "precision adjustment zone". When the object approaches from the front, the detection zone of the object ranges from the stored position down to zero.

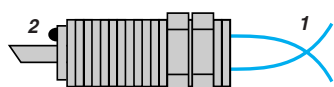
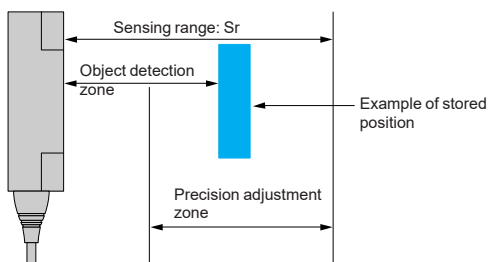

1 Detection threshold curves
 2 "Object detected" LED

Operating zone

- The operating zone relates to the area in front of the sensing face in which the detection of a metal object is certain. The values stated in the characteristics relating to the various types of sensor are for steel objects of a size equal to the sensing face of the sensor. For objects of a different nature (smaller than the sensing face of the sensor, other metals, etc.), it is necessary to apply a correction coefficient.

Correction coefficients to apply to the assured operating distance

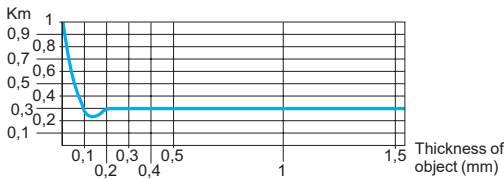
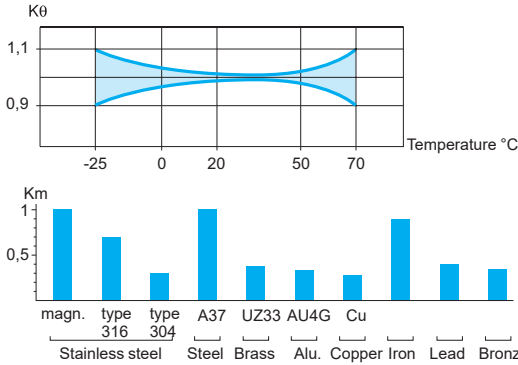

Typical curve for a copper object used with a Ø 18 mm cylindrical sensor

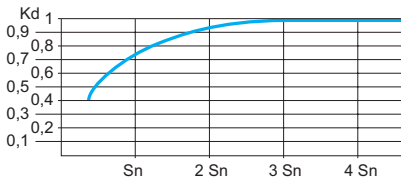

Typical curve for a steel object used with a cylindrical sensor

Assured operating distance of a sensor

In practice, most objects to be detected are generally made of steel and are of a size equal to, or greater, than the sensing face of the sensor.

For the calculation of the assured operating distance for different operating conditions, one must take into account the correction coefficients that influence it.

The curves indicated are purely representative of typical curves. They are only given as a guide to the approximate usable sensing distance of a proximity sensor for a given application.

Influence of ambient temperature

Apply a correction coefficient K_{θ} , determined from the curve shown opposite.

Material of object to be detected

Apply a correction coefficient K_m , determined from the diagram shown opposite.

The fixed sensing distance models for ferrous/non ferrous (Fe/NFe) materials enable the detection of different objects at a fixed distance, irrespective of the type of material.

Special case of a very thin object made of a non ferrous material.

Size of object to be detected

Apply a correction coefficient K_d , determined from the curve shown opposite. When calculating the sensing distance for the selection of a sensor, make the assumption that $K_d = 1$.

Variation of supply voltage

In all cases, apply the correction coefficient $K_t = 0.9$.

Calculation examples

Correction of the sensing distance of a sensor

Sensor with nominal sensing distance $S_n = 15$ mm.
 Ambient temperature variation 0 to + 20 °C.
 Object material and size: steel, 30 x 30 x 1 mm thick.
 The assured sensing distance S_a is determined using the formula:
 $S_a = S_n \times K_{\theta} \times K_m \times K_d \times K_t = 15 \times 0.98 \times 1 \times 0.95 \times 0.9$
 i.e. $S_a = 12.5$ mm.

Selecting a sensor for a given application

Application characteristics:
 - object material and size: iron ($K_m = 0.9$), 30 x 30 mm,
 - temperature: 0 to 20 °C ($K_{\theta} = 0.98$),
 - object detection distance: 3 mm ± 1.5 mm, i.e. $S_a \text{ max.} = 4.5$ mm,
 - assume $K_d = 1$.
 A sensor must be selected for which $S_n \geq \frac{S_a}{K_{\theta} \times K_m \times K_d \times K_t} = \frac{4.5}{0.98 \times 0.9 \times 1 \times 0.9}$
 i.e. $S_n \geq 5.7$ mm

Specific aspects of electronic sensors

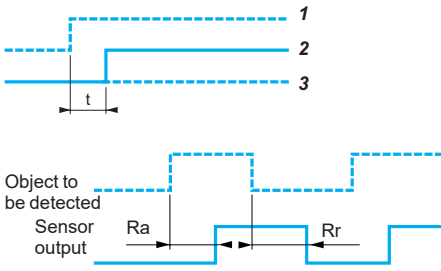
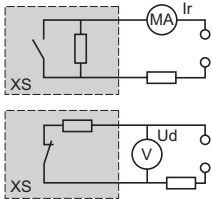

Supply

Terminology

- Residual current (Ir)
 - The residual current (Ir) corresponds to the current flowing through the sensor when in the "open" state.
 - Characteristic of 2-wire type proximity sensors.
- Voltage drop (Ud)
 - The voltage drop (Ud) corresponds to the voltage drop at the sensor's terminals when in the "closed" state (value measured at nominal current rating of sensor).
- First-up delay
 - The first-up delay corresponds to the time (t) between the connection of the power supply to the sensor and its fully operational state.
 - 1 Supply voltage U on
 - 2 Sensor operational at state 1
 - 3 Sensor at state 0
- Response time
 - Response time (Ra): the time delay between the object to be detected entering the sensor's operating zone and the subsequent change of output state. This parameter limits the speed and size of the object.
 - Recovery time (Rr): the time delay between an object to be detected leaving the sensor's operating zone and the subsequent change of output state. This parameter limits the interval between successive objects.

Sensors for AC circuits (~ and ~ models)

Check that the voltage limits of the sensor are compatible with the nominal voltage of the AC supply used.

Sensors for DC circuits

- **DC source:** check that the voltage limits of the sensor and the acceptable level of ripple are compatible with the supply used.
- **AC source** (comprising transformer, rectifier, smoothing capacitor): the supply voltage must be within the operating limits specified for the sensor.

Where the voltage is derived from a single-phase AC supply, the voltage must be rectified and smoothed to ensure that:

- the peak voltage of the DC supply is lower than the maximum voltage rating of the sensor.
- the minimum voltage of the supply is greater than the minimum voltage rating of the sensor,

given that :
 $\Delta V = (I \times t) / C$

$\Delta V = \text{max. ripple: } 10\% (V),$
 $I = \text{anticipated load current (mA),}$
 $t = \text{period of 1 cycle (10 ms full-wave rectified for a 50 Hz supply frequency),}$
 $C = \text{capacitance (}\mu\text{F).}$

As a general rule, use a transformer with a lower secondary voltage (Ue) than the required DC voltage (U).

Example:
 $\sim 18\text{ V to obtain } \text{---} 24\text{ V,}$
 $\sim 36\text{ V to obtain } \text{---} 48\text{ V.}$

Outputs

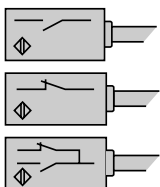

Output signal (contact logic)

- **Normally open (NO)**
Corresponds to a sensor whose output changes to the closed state when an object is present in the operating zone.
- **Normally closed (NC)**
Corresponds to a sensor whose output changes to the open state when an object is present in the operating zone.
- **Complementary outputs (NO + NC)**
Corresponds to a sensor with a normally closed output and a normally open output.

Outputs (continued)

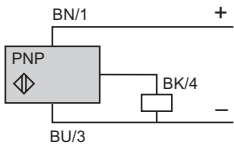
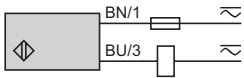
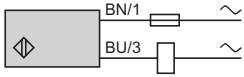
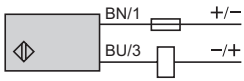

NO output

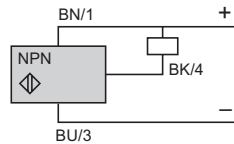

NO output

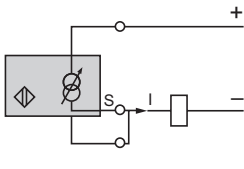
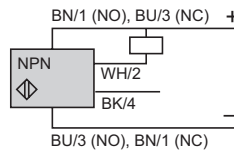
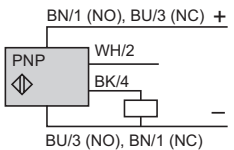
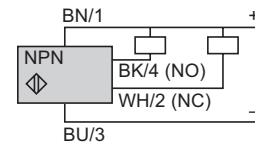
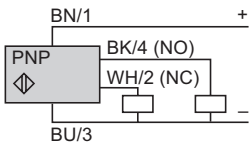

2-wire connection

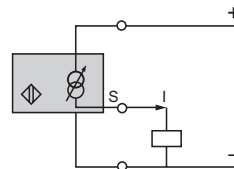

3-wire connection

2-wire type, non polarised NO or NC output

■ **Specific aspects**

These sensors are wired in series with the load to be switched.

As a consequence, they are subject to:

- a residual current in the open state (current flowing through the sensor in the “open” state),
- A voltage drop in the closed state (voltage drop across the sensor’s terminals in the “closed” state).

■ **Advantages**

- Only 2 leads to be wired: these sensors can be wired in series in the same way as mechanical limit switches,
- They can be connected to either positive (PNP) or negative (NPN) logic PLC inputs,
- No risk of incorrect connections.

■ **Operating precautions**

- Check the possible effects of residual current and voltage drop on the actuator or input connected,
- For sensors that do not have overload and short-circuit protection (AC or AC/DC symbol), it is essential to connect a 0.4 A “quick-blow” fuse in series with the load.

3-wire type, NO or NC output, PNP or NPN

■ **Specific aspects**

These sensors comprise 2 wires for the DC supply and a 3rd wire for the output signal,

- PNP type: switching the positive side to the load,
- NPN type: switching the negative side to the load.

■ **Advantages**

- Protection against supply reverse polarity,
- Protection against overload and short-circuit,
- No residual current, low voltage drop.

4-wire type, complementary NO and NC outputs, PNP or NPN

■ **Advantages**

- Protection against supply reverse polarity (+/-).
- Protection against overload and short-circuit.

4-wire type, multifunction, programmable NO or NC output, PNP or NPN

■ **Advantages**

- Protection against supply reverse polarity (+/-).
- Protection against overload and short-circuit.

Specific output signals, analogue type

■ These sensors convert the approach of a metal object towards the sensing face into an output current variation which is proportional to the distance between the object and the sensing face.

■ Two models available:

- 0...10 V (0...10 mA) output for 3-wire connection,
- 4-20 mA output for 2-wire connection.

Features of the various models

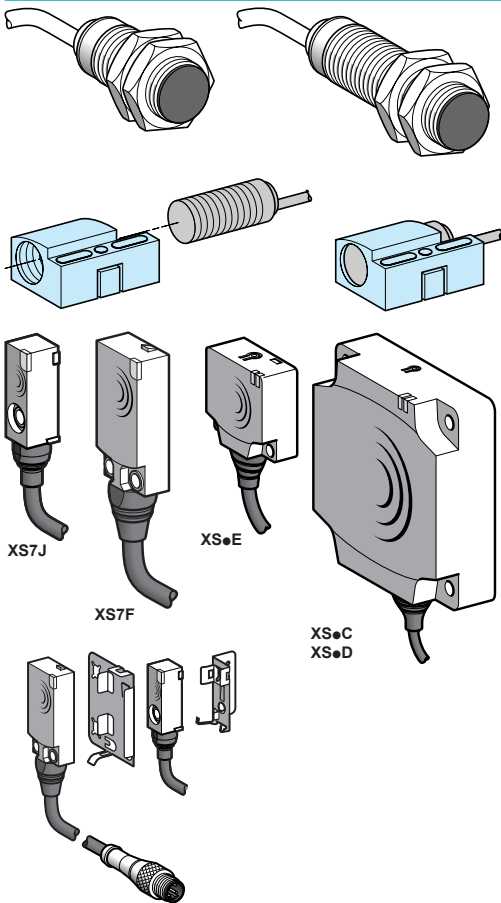

Types of case

- **Cylindrical case**
 - Fast installation and setting-up.
 - Short case and long case, 2-wire and 3-wire versions available.
 - Pre-cabled (moulded cable) and various integral connector (M8, M12, 7/8", M18) and remote connector (on flying lead) versions available.
 - Small size facilitates mounting in locations with restricted access.
 - **Interchangeability**, provided by indexed **fixing clamp**: when assembled, becomes similar to a block type sensor.

- **Flat case**
 - Reduced size (sensor volume divided by 8).
 - Fast installation by mounting on clip-on brackets.
 - Precision detection with the flush mountable sensors using teach mode (see page 70).

Electrical connection

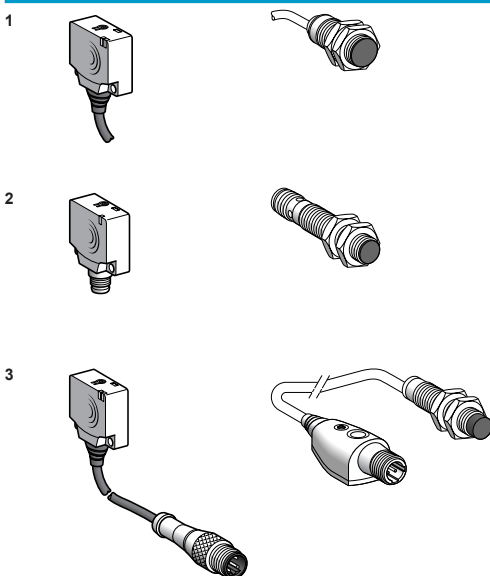

Connection methods

- 1 **Pre-cabled**: factory fitted moulded cable, good protection against splashing liquids (IP 68). Example: machine tool.
- 2 **Connector**: easy installation and maintenance (IP 67).
- 3 **Remote connector**: easy installation and maintenance (IP 68 at sensor level and IP 67 at remote connector level).

Wiring advice

- **Length of cable**
 - No limitation up to 200 m or up to a line capacitance of < 100 nF (characteristics of sensor remain unaffected).
 - In this case, it is important to take into account the voltage drop on the line.
- **Separation of control and power circuit wiring**
 - The sensors are immune to electrical interference encountered in normal industrial conditions.
 - Where extreme conditions of electrical "noise" could occur (large motors, spot welders, etc.), it is advisable to protect against transients in the normal way:
 - suppress interference at source,
 - separate power and control wiring from each other,
 - smooth the supply,
 - limit the length of cable.
- **Connect the sensor with supply switched off.**

Setting-up precautions

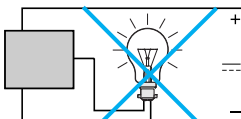
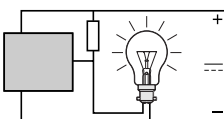
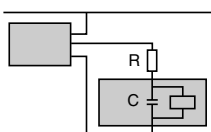
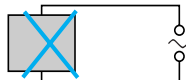
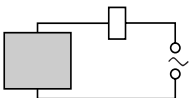
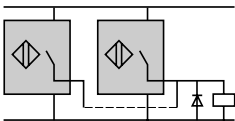
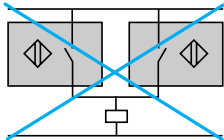
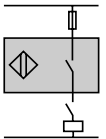
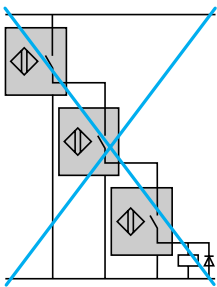
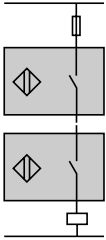

Connection in series

2-wire type sensors

- The following points should be taken into account:
 - Series wiring is only possible using sensors with wide voltage limits. Based on the assumption that each sensor has the same residual current value, each sensor, in the open state, will share the supply voltage, i.e.

$$U_{\text{sensor}} = \frac{U_{\text{supply}}}{n_{\text{sensors}}}$$

- U sensor and U supply must remain within the sensor's voltage limits.
 - If only one sensor in the circuit is in the open state, it will be supplied at a voltage almost equal to the supply voltage.
 - When in the closed state, a small voltage drop is present across each sensor. The resultant loss of voltage at the load will be the sum of the individual voltage drops and therefore, the load voltage should be selected accordingly.

3-wire type sensors

This connection method is not recommended.

- Correct operation of the sensors cannot be assured and, if this method is used, tests should be made before installation.
 - The following points should be taken into account:
 - Sensor 1 carries the load current in addition to the no-load current consumption values of the other sensors connected in series. For certain models, this connection method is not possible unless a current limiting resistor is used.
 - When in the closed state, a small voltage drop is present across each sensor. The load should therefore be selected accordingly.
 - As sensor 1 closes, sensor 2 does not operate until a certain time (t) has elapsed (corresponding to the first-up delay) and likewise for the following sensors in the sequence.
 - The use of "flywheel" diodes is recommended when an inductive load is being switched.

Sensors and devices in series with an external mechanical contact

2 and 3-wire type sensors

- The following points should be taken into account:
 - When the mechanical contact is open, the sensor is not supplied.
 - When the contact closes, the sensor does not operate until a certain time (t) has elapsed (corresponding to the first-up delay).

Connection in parallel

2-wire type sensors

This connection method is not recommended.

- Should one of the sensors be in the closed state, the sensor in parallel will be "shorted-out" and no longer supplied.
 - As the first sensor passes into the open state, the second sensor will become energised and will be subject to its first-up delay.
- This configuration is only permissible where the sensors will be working alternately.
- This method of connection can lead to irreversible damage of the units.

3-wire type sensors

- No specific restrictions. The use of "flywheel" diodes is recommended when an inductive load (relay) is being switched.

AC supply

- 2-wire type sensors cannot be connected directly to an AC supply.
 - This would result in immediate destruction of the sensor and considerable danger to the user.
 - An appropriate load (refer to the instruction sheet supplied with the sensor) must always be connected in series with the sensor.

Capacitive load (C > 0.1 μF)

- On power-up, it is necessary to limit (by resistor) the charging current of the capacitive load C.
 - The voltage drop in the sensor can also be taken into account by subtracting it from the supply voltage for the calculation of R.

$$R = \frac{U_{\text{supply}}}{I_{\text{max. (sensor)}}$$

Load comprising an incandescent lamp

- If the load comprises an incandescent lamp, the cold state resistance can be 10 times lower than the hot state resistance. This can cause very high current levels on switching. Fit a pre-heat resistor in parallel with the sensor.

$$R = \frac{U^2}{P} \times 10, U = \text{supply voltage and } P = \text{lamp power}$$

Fast trouble shooting guide

Problem	Possible causes	Remedy
The sensor's output will not change state when a metal object enters the detection zone	On a flush mountable sensor using teach mode: setting-up or programming error.	<ul style="list-style-type: none"> ■ After a RESET, follow the environment teach mode procedure. Refer to instruction sheet supplied with sensor.
	Output stage faulty or complete failure of the sensor or the short-circuit protection has tripped.	<ul style="list-style-type: none"> ■ Check that the sensor is compatible with the supply being used. ■ Check the load current characteristics: <ul style="list-style-type: none"> □ if load current $I \geq$ maximum switching capacity, an auxiliary relay, of the CAD N type for example, should be interposed between the sensor and the load, □ if $I \leq$ maximum switching capacity, check for wiring faults (short-circuit). ■ In all cases, a 0.4 A "quick-blow" fuse should be fitted in series with the sensor.
	Wiring error	<ul style="list-style-type: none"> ■ Check that the wiring conforms to the wiring shown on the sensor label or instruction sheet.
False or erratic operation, with or without the presence of a metal object in the detection zone	Supply fault	<ul style="list-style-type: none"> ■ Check that the sensor is compatible with the supply (\sim or ---). ■ Check that the supply voltage is within the voltage limits of the sensor. Remember that with a rectified, smoothed supply, $U_{\text{peak}} = U_{\text{nominal}} \times \sqrt{2}$ with a ripple voltage $\leq 10\%$.
	On flush mountable sensor using teach mode: setting-up or programming error.	<ul style="list-style-type: none"> ■ After a RESET, follow the environment teach mode procedure. Refer to instruction sheet supplied with sensor.
	Influence of background or metal environment	<ul style="list-style-type: none"> ■ Refer to the instruction sheet supplied with the sensor. For sensors with adjustable sensitivity, reduce the sensing distance.
	Sensing distance poorly defined for the object to be detected	<ul style="list-style-type: none"> ■ Apply the correction coefficients. ■ Realign the system or run the teach mode again.
	Influence of transient interference on the supply lines	<ul style="list-style-type: none"> ■ Ensure that any DC supplies, when derived from rectified AC, are correctly smoothed ($C > 400 \mu\text{F}$). ■ Separate AC power cables from low-level DC cables (24 V low level). ■ Where very long distances are involved, use suitable cable: screened and twisted pairs of the correct cross-sectional area.
	Equipment prone to emitting electromagnetic interference	<ul style="list-style-type: none"> ■ Position the sensors as far away as possible from any sources of interference.
	Response time of the sensor too slow for the particular object being detected	<ul style="list-style-type: none"> ■ Check the suitability of the sensor for the position or size of the object to be detected. ■ If necessary, select a sensor with a higher switching frequency.
No detection following a period of service	Influence of high temperature	<ul style="list-style-type: none"> ■ Eliminate sources of radiated heat or protect the sensor casing with a heat shield. ■ Realign, having adjusted the temperature around the fixing support.
	Vibration, shock	<ul style="list-style-type: none"> ■ Realign the system. ■ Replace the support or protect the sensor.

Inductive proximity sensors

XS range, general purpose

Cylindrical, standard range, flush mountable

Three-wire DC, solid-state output

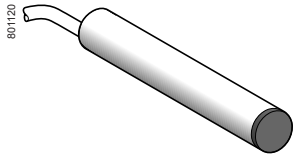

XS506B1●●L2

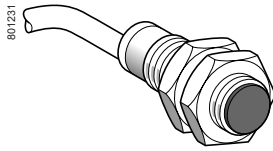

XS508B1●●L2

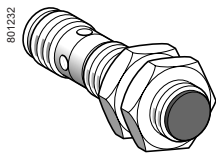

XS512B1●●M12

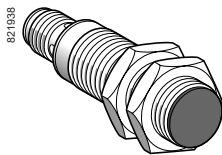

XS518B1●●M12

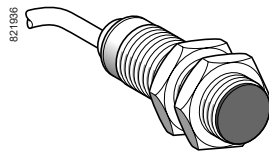

XS518B1●●L2

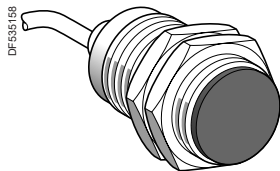

XS530B1●●L2

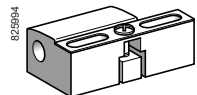

XSZB1●●

Sensors, 3-wire 12-24 V, short case model

Sensing distance (Sn) mm	Function	Output	Connection	Reference	Weight kg
Ø 6.5, plain					
1.5	NO	PNP	Pre-cabled (L = 2 m) (1)	XS506B1PAL2	0.035
			M8 connector	XS506B1PAM8	0.025
			M12 connector	XS506B1PAM12	0.025
	NPN	PNP	Pre-cabled (L = 2 m) (1)	XS506B1NAL2	0.035
			M8 connector	XS506B1NAM8	0.025
			M12 connector	XS506B1NAM12	0.025
NC	PNP	Pre-cabled (L = 2 m) (1)	XS506B1PBL2	0.035	
		M8 connector	XS506B1PBM8	0.025	
		M12 connector	XS506B1PBM12	0.025	
1.5	NO	PNP	Pre-cabled (L = 2 m) (1)	XS508B1PAL2	0.035
			M8 connector	XS508B1PAM8	0.025
			M12 connector	XS508B1PAM12	0.025
	NPN	PNP	Pre-cabled (L = 2 m) (1)	XS508B1NAL2	0.035
			M8 connector	XS508B1NAM8	0.025
			M12 connector	XS508B1NAM12	0.025
NC	PNP	Pre-cabled (L = 2 m) (1)	XS508B1PBL2	0.035	
		M8 connector	XS508B1PBM8	0.025	
		M12 connector	XS508B1PBM12	0.025	
2	NO	PNP	Pre-cabled (L = 2 m) (1)	XS512B1PAL2	0.075
			M12 connector	XS512B1PAM12	0.035
			M12 connector	XS512B1NAM12	0.035
	NPN	PNP	Pre-cabled (L = 2 m) (1)	XS512B1NAL2	0.075
			M12 connector	XS512B1NAM12	0.035
			M12 connector	XS512B1NAM12	0.035
NC	PNP	Pre-cabled (L = 2 m) (1)	XS512B1PBL2	0.075	
		M12 connector	XS512B1PBM12	0.035	
		M12 connector	XS512B1PBM12	0.035	
5	NO	PNP	Pre-cabled (L = 2 m) (1)	XS518B1PAL2	0.120
			M12 connector	XS518B1PAM12	0.060
			M12 connector	XS518B1NAM12	0.060
	NPN	PNP	Pre-cabled (L = 2 m) (1)	XS518B1NAL2	0.120
			M12 connector	XS518B1NAM12	0.060
			M12 connector	XS518B1NAM12	0.060
NC	PNP	Pre-cabled (L = 2 m) (1)	XS518B1PBL2	0.120	
		M12 connector	XS518B1PBM12	0.060	
		M12 connector	XS518B1PBM12	0.060	
10	NO	PNP	Pre-cabled (L = 2 m) (1)	XS530B1PAL2	0.205
			M12 connector	XS530B1PAM12	0.145
			M12 connector	XS530B1NAM12	0.145
	NPN	PNP	Pre-cabled (L = 2 m) (1)	XS530B1NAL2	0.205
			M12 connector	XS530B1NAM12	0.145
			M12 connector	XS530B1NAM12	0.145
NC	PNP	Pre-cabled (L = 2 m) (1)	XS530B1PBL2	0.205	
		M12 connector	XS530B1PBM12	0.145	
		M12 connector	XS530B1PBM12	0.145	

Accessories (2)

Description	For use with sensors	Reference	Weight kg
Fixing clamps	Ø 6.5 (plain)	XSZB165	0.005
	Ø 8	XSZB108	0.006
	Ø 12	XSZB112	0.006
	Ø 18	XSZB118	0.010
	Ø 30	XSZB130	0.020

(1) For a 5 m cable replace L2 by L5; for a 10 m cable replace L2 by L10. Please consult our Customer Care Centre for availability.

Example: XS508B1PAL2 becomes XS508B1PAL5 with a 5 m cable.

(2) For more information, see page 118.

Inductive proximity sensors

XS range, general purpose

Cylindrical, standard range, flush mountable

Three-wire DC, solid-state output

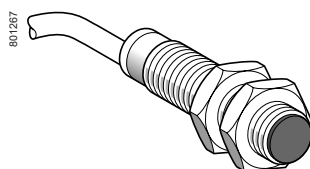

XS5●●BL●●L2

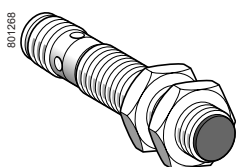

XS5●●BL●●M12

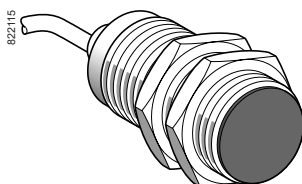

XS530BL●●L2

Sensors, 3-wire $\overline{\text{DC}}$ 12-48 V, long case model

Sensing distance (Sn) mm	Function	Output	Connection	Reference	Weight kg
Ø 8, threaded M8 x 1					
1.5	NO	PNP	Pre-cabled (L = 2 m) (1)	XS508BLPAL2	0.035
			M12 connector	XS508BLPAM12	0.025
	NPN	PNP	Pre-cabled (L = 2 m) (1)	XS508BLNAL2	0.035
			M12 connector	XS508BLNAM12	0.025
	NC	PNP	Pre-cabled (L = 2 m) (1)	XS508BLPBL2	0.035
			M12 connector	XS508BLPBM12	0.025
NPN	PNP	Pre-cabled (L = 2 m) (1)	XS508BLNBL2	0.035	
		M12 connector	XS508BLNBM12	0.025	
Ø 12, threaded M12 x 1					
2	NO	PNP	Pre-cabled (L = 2 m) (1)	XS512BLPAL2	0.075
			M12 connector	XS512BLPAM12	0.035
	NPN	PNP	Pre-cabled (L = 2 m) (1)	XS512BLNAL2	0.075
			M12 connector	XS512BLNAM12	0.035
	NC	PNP	Pre-cabled (L = 2 m) (1)	XS512BLPBL2	0.075
			M12 connector	XS512BLPBM12	0.035
NPN	PNP	Pre-cabled (L = 2 m) (1)	XS512BLNBL2	0.075	
		M12 connector	XS512BLNBM12	0.035	
Ø 18, threaded M18 x 1					
5	NO	PNP	Pre-cabled (L = 2 m) (1)	XS518BLPAL2	0.120
			M12 connector	XS518BLPAM12	0.060
	NPN	PNP	Pre-cabled (L = 2 m) (1)	XS518BLNAL2	0.120
			M12 connector	XS518BLNAM12	0.060
	NC	PNP	Pre-cabled (L = 2 m) (1)	XS518BLPBL2	0.120
			M12 connector	XS518BLPBM12	0.060
NPN	PNP	Pre-cabled (L = 2 m) (1)	XS518BLNBL2	0.120	
		M12 connector	XS518BLNBM12	0.060	
Ø 30, threaded M30 x 1.5					
10	NO	PNP	Pre-cabled (L = 2 m) (1)	XS530BLPAL2	0.205
			M12 connector	XS530BLPAM12	0.145
	NPN	PNP	Pre-cabled (L = 2 m) (1)	XS530BLNAL2	0.205
			M12 connector	XS530BLNAM12	0.145
	NC	PNP	Pre-cabled (L = 2 m) (1)	XS530BLPBL2	0.205
			M12 connector	XS530BLPBM12	0.145
NPN	PNP	Pre-cabled (L = 2 m) (1)	XS530BLNBL2	0.205	
		M12 connector	XS530BLNBM12	0.145	

Accessories (2)

Description	For use with sensors	Reference	Weight kg
Fixing clamps	Ø 6.5 (plain)	XSZB165	0.005
	Ø 8	XSZB108	0.006
	Ø 12	XSZB112	0.006
	Ø 18	XSZB118	0.010
	Ø 30	XSZB130	0.020

(1) For a 5 m cable replace L2 by L5; for a 10 m cable replace L2 by L10. Please consult our Customer Care Centre for availability.

Example: XS508BLPAL2 becomes XS508BLPAL5 with a 5 m cable.

(2) For more information, see page 118.

Inductive proximity sensors

XS range, general purpose

Cylindrical, standard range, flush mountable

Three-wire DC, solid-state output

Characteristics			
Sensor type		XS5●●B1●●M8, XS5●●B1●●M12 XS5●●BL●●M8, XS5●●BL●●M12	XS5●●B1●●L2 XS5●●BL●●L2
Product certifications		UL, CSA, CE, E2	
Connection	Connector	M8 on Ø 6.5 and Ø 8, M12 on Ø 8, Ø 12, Ø 18 and Ø 30	–
	Pre-cabled	–	Length: 2 m
Operating zone	Ø 6.5 and Ø 8	mm	0...1.2
	Ø 12	mm	0...1.6
	Ø 18	mm	0...4
	Ø 30	mm	0...8
Differential travel		%	1...15 of effective sensing distance (Sr)
Degree of protection	Conforming to IEC 60529	IP 65 and IP 67	
	Conforming to DIN 40050	IP 69K for Ø 12 to Ø 30	
Storage temperature		°C	-40...+85
Operating temperature		°C	-25...+70
Materials	Case	Nickel plated brass (except XS506 and XS508: stainless steel, grade 303)	
	Sensing face	PPS	
	Cable	–	PvR 3 x 0.34 mm ² except XS506 and XS508 : 3 x 0.11 mm ²
Vibration resistance	Conforming to IEC 60068-2-6	25 gn, amplitude ± 2 mm (f = 10 to 50 Hz)	
Shock resistance	Conforming to IEC 60068-2-27	50 gn, duration 11 ms	
Output state indication		Yellow LED: 4 viewing ports at 90°	Yellow LED: annular
Rated supply voltage		V	--- 12...48 for XS5●●BL --- 12...24 for XS5●●B1 with protection against reverse polarity
Voltage limits (including ripple)		V	--- 10...58 for XS5●●BL --- 10...36 for XS5●●B1
Switching capacity		mA	≤ 200 with overload and short-circuit protection
Voltage drop, closed state		V	≤ 2
Current consumption, no-load		mA	≤ 10
Maximum switching frequency	XS506, XS508, XS512	Hz	5000
	XS518	Hz	2000
	XS530	Hz	1000
Delays	First-up	ms	≤ 10
	Response	ms	≤ 0.1: XS506, XS508 and XS512 ≤ 0.15: XS518 ≤ 0.3: XS530
	Recovery	ms	≤ 0.1: XS506, XS508 and XS512 ≤ 0.35: XS518 ≤ 0.7: XS530

Inductive proximity sensors

XS range, general purpose

Cylindrical, standard range, flush mountable

Three-wire DC, solid-state output

Wiring schemes

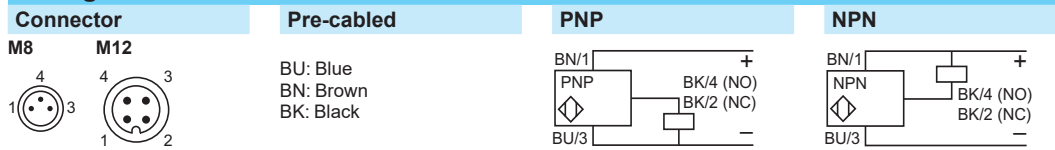

For M8 connector, NO and NC outputs on terminal 4

Setting-up

Minimum mounting distances (mm)

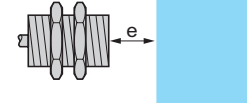
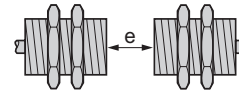
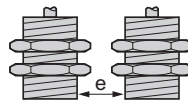

Flush mountable sensors	Side by side	Face to face	Facing a metal object
Ø 6.5	$e \geq 3$	$e \geq 18$	$e \geq 4.5$
Ø 8	$e \geq 3$	$e \geq 18$	$e \geq 4.5$
Ø 12	$e \geq 4$	$e \geq 24$	$e \geq 6$
Ø 18	$e \geq 10$	$e \geq 60$	$e \geq 15$
Ø 30	$e \geq 20$	$e \geq 120$	$e \geq 30$

Dimensions

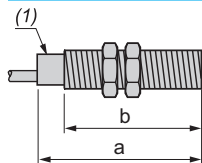

(1) LED

Sensors		Pre-cabled (mm)		M8 connector (mm)		M12 connector (mm)	
Short case model		a	b	a	b	a	b
Ø 6.5	XS506B1	34	–	42	–	45	–
Ø 8	XS508B1	34	25	42	27	45	23
Ø 12	XS512B1	37	25	–	–	50	30
Ø 18	XS518B1	39	28	–	–	50	28
Ø 30	XS530B1	43	32	–	–	54	32

Sensors		Pre-cabled (mm)		M12 connector (mm)	
Long case model		a	b	a	b
Ø 8	XS508BL	51	42	61	40
Ø 12	XS512BL	53	42	61	42
Ø 18	XS518BL	62	52	74	52
Ø 30	XS530BL	62	52	74	52

Inductive proximity sensors

XS range, general purpose

Cylindrical, standard range, flush mountable

Two-wire DC

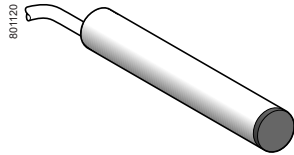

XS506BS●●L2

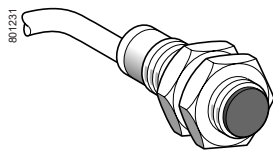

XS512BS●●L2

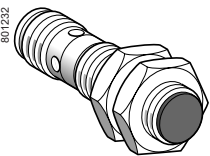

XS5●●BS●●M12

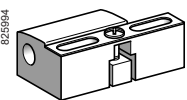

XSZB1●●

Sensors, 2-wire $\overline{\text{DC}}$ 12-24 V, short case model

Sensing distance (Sn) mm	Function	Connection	Reference	Weight kg
Ø 6.5, plain				
1.5	NO terminals 1 & 4 (2)	Pre-cabled (L = 2 m) (1)	XS506BSCAL2	0.035
		Remote M12 connector	XS506BSCAL01M12	0.050
	NC	Pre-cabled (L = 2 m) (1)	XS506BSCBL2	0.035
Ø 8, threaded M8 x 1				
1.5	NO terminals 1 & 4 (2)	Pre-cabled (L = 2 m) (1)	XS508BSCAL2	0.035
		Remote M12 connector	XS508BSCAL01M12	0.050
		Remote M12 connector	XS508BSCAL08M12	0.050
	NC	Pre-cabled (L = 2 m) (1)	XS508BSCBL2	0.035
		Remote M12 connector	XS508BSCBL01M12	0.050
Ø 12, threaded M12 x 1				
2	NO	Pre-cabled (L = 2 m) (1)	XS512BSDAL2	0.075
		M12 connector	XS512BSDAM12	0.035
	NO terminals 1 & 4 (2)	M12 connector	XS512BSCAM12	0.035
		Remote M12 connector	XS512BSCAL08M12	0.060
	NC	Pre-cabled (L = 2 m) (1)	XS512BSDBL2	0.075
	M12 connector	XS512BSDBM12	0.035	
Ø 18, threaded M18 x 1				
5	NO	Pre-cabled (L = 2 m) (1)	XS518BSDAL2	0.120
		M12 connector	XS518BSDAM12	0.060
	NO terminals 1 & 4 (2)	M12 connector	XS518BSCAM12	0.060
		Remote M12 connector	XS518BSCAL08M12	0.085
	NC	Pre-cabled (L = 2 m) (1)	XS518BSDBL2	0.120
	M12 connector	XS518BSDBM12	0.060	
Ø 30, threaded M30 x 1.5				
10	NO	Pre-cabled (L = 2 m) (1)	XS530BSDAL2	0.205
		M12 connector	XS530BSDAM12	0.145
	NO terminals 1 & 4 (2)	M12 connector	XS530BSCAM12	0.145
		Remote M12 connector	XS530BSCAL08M12	0.170
	NC	Pre-cabled (L = 2 m) (1)	XS530BSDBL2	0.205
	M12 connector	XS530BSDBM12	0.145	
Accessories (3)				
Description	For use with sensors	Reference	Weight kg	
Fixing clamps	Ø 6.5 (plain)	XSZB165	0.005	
	Ø 8	XSZB108	0.006	
	Ø 12	XSZB112	0.006	
	Ø 18	XSZB118	0.010	
	Ø 30	XSZB130	0.020	

(1) For a 5 m cable replace L2 by L5; for a 10 m cable replace L2 by L10. Please consult our Customer Care Centre for availability.

Example: XS508BSCAL2 becomes **XS508BSCAL5** with a 5 m cable.

(2) The NO output is connected to terminals 1 and 4 of the M12 connector.

(3) For more information, see page 118.

Inductive proximity sensors

XS range, general purpose

Cylindrical, standard range, flush mountable

Two-wire DC

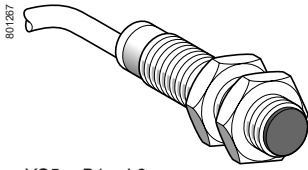

XS500B100L2

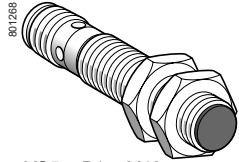

XS500B100M12

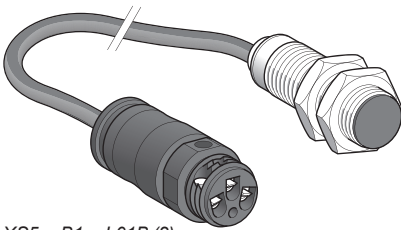

XS500B100L01B (2)

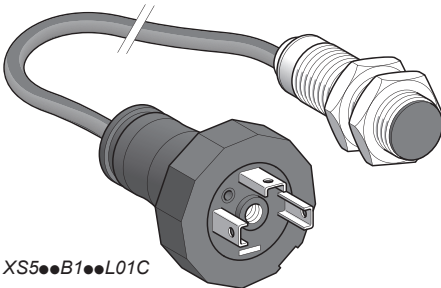

XS500B100L01C

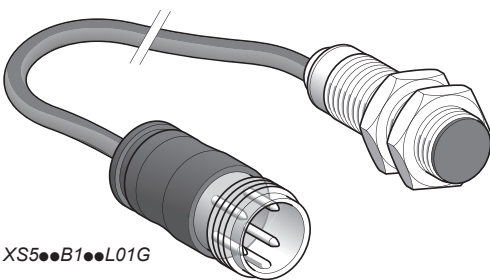

XS500B100L01G

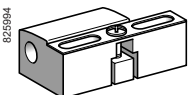

XSZB100

Sensors, 2-wire 12-48 V, long case model

Sensing distance (Sn) mm	Function	Connection	Reference	Weight kg		
Ø 8, threaded M8 x 1						
1.5	NO	Pre-cabled (L = 2 m) (1)	XS508B1DAL2	0.035		
		Remote M12 connector	XS508B1DAL08M12	0.050		
		M12 connector	XS508B1DAM12	0.025		
NO terminals 1 & 4 (3)	M12 connector	XS508B1CAM12	0.025			
	Remote M12 connector	XS508B1CAL08M12	0.050			
NC		Pre-cabled (L = 2 m) (1)	XS508B1DBL2	0.035		
		M12 connector	XS508B1DBM12	0.025		
Ø 12, threaded M12 x 1						
2	NO	Pre-cabled (L = 2 m) (1)	XS512B1DAL2	0.075		
		Remote 7/8" connector	XS512B1DAL08U78	0.050		
		M12 connector	XS512B1DAM12	0.035		
NO terminals 1 & 4 (3)	M12 connector	XS512B1CAM12	0.035			
	Remote M12 connector	XS512B1CAL08M12	0.060			
NC		Pre-cabled (L = 2 m) (1)	XS512B1DBL2	0.075		
		M12 connector	XS512B1DBM12	0.035		
		Remote M12 connector	XS512B1DBL08M12	0.060		
Ø 18, threaded M18 x 1						
5	NO	Pre-cabled (L = 2 m) (1)	XS518B1DAL2	0.120		
		Low temperature version (-40 °C)	XS518B1DAL2TF (5)	0.120		
		Remote screw terminal connector (2)	XS518B1DAL01B	0.085		
		Remote EN 175301-803-A connector	XS518B1DAL01C	0.085		
		Remote M18 connector	XS518B1DAL01G	0.085		
		M12 connector	XS518B1DAM12	0.060		
		NO terminals 1 & 4 (3)	M12 connector	XS518B1CAM12	0.060	
Remote M12 connector	XS518B1CAL08M12	0.085				
	NC		Pre-cabled (L = 2 m) (1)	XS518B1DBL2	0.120	
M12 connector	XS518B1DBM12		0.060			
Remote M12 connector	XS518B1DBL08M12		0.085			
Remote screw terminal connector (2)	XS518B1DBL01B		0.120			
Ø 30, threaded M30 x 1.5						
10	NO	Pre-cabled (L = 2 m) (1)	XS530B1DAL2	0.205		
		Low temperature version (-40 °C)	XS530B1DAL2TF (5)	0.205		
		M12 connector	XS530B1DAM12	0.145		
		Remote screw terminal connector (2)	XS530B1DAL01B	0.205		
		Remote EN 175301-803-A connector	XS530B1DAL01C	0.205		
		Remote M18 connector	XS530B1DAL01G	0.205		
		NO terminals 1 & 4 (3)	M12 connector	XS530B1CAM12	0.145	
		Remote M12 connector	XS530B1CAL08M12	0.170		
		NC		Pre-cabled (L = 2 m) (1)	XS530B1DBL2	0.205
				M12 connector	XS530B1DBM12	0.145
Remote screw terminal connector (2)	XS530B1DBL01B	0.205				

Accessories (4)

Description	For use with sensors	Reference	Weight kg
Fixing clamps	Ø 8	XSZB108	0.006
	Ø 12	XSZB112	0.006
	Ø 18	XSZB118	0.010
	Ø 30	XSZB130	0.020

(1) For a 5 m cable replace L2 by L5; for a 10 m cable replace L2 by L10. Please consult our Customer Care Centre for availability.

Example: XS508B1DAL2 becomes **XS508B1DAL5** with a 5 m cable.

(2) Protective cable gland included with sensor.

(3) The NO output is connected to terminals 1 and 4 of the M12 connector.

(4) For more information, see page 118.

(5) For a 5 m cable replace L2 by L5. Please consult our Customer Care Centre for availability.

Example: XS518B1DAL2TF becomes **XS518B1DAL5TF** with a 5 m cable.

For a PUR cable, replace the letter L by P in the reference.

Example: XS518B1DAL2TF becomes **XS518B1DAP2TF**.

For a 5 m PUR cable, replace P2 by P5.

Example: XS518B1DAP2TF becomes **XS518B1DAP5TF** with a 5 m PUR cable.

Inductive proximity sensors

XS range, general purpose

Cylindrical, standard range, flush mountable

Two-wire DC

Characteristics			
Sensor type		XS5●●B1●●M12, XS5●●BS●●M12	XS5●●B1D●L2, XS5●●BS●●L2
Product certifications		UL, CSA, CE	
Connection	Connector	M12	–
	Pre-cabled	–	Length: 2 m
	Remote connector	M12 (L01M12), screw terminal (L01B), EN 175301-803-A (L01C) and M18 (L01G) remote connectors on 0.15 m flying lead M12 (L08M12) and 7/8" (L08U78) remote connectors on 0.80 m flying lead	
Operating zone	Ø 6.5	mm	0...1.2
	Ø 8	mm	0...1.2
	Ø 12	mm	0...1.6
	Ø 18	mm	0...4
	Ø 30	mm	0...8
Differential travel		%	1...15 of effective sensing distance (Sr)
Degree of protection	Conforming to IEC 60529	IP 65 and IP 67	IP 65 and IP 68, double insulation ☐ (except Ø 6.5 and Ø 8: IP 67)
Storage temperature		°C	-40...+85
Operating temperature		°C	-25...+70; TF products: -40...+70
Materials	Case	Nickel plated brass (except XS506 and XS508B1: stainless steel, grade 303)	
	Sensing face	PPS	
	Cable	–	PvR 2 x 0.34 mm ² (except XS506 and XS508: 2 x 0.11 mm ²) PUR available (1)
Vibration resistance	Conforming to IEC 60068-2-6	25 gn, amplitude ± 2 mm (f = 10 to 55 Hz)	
Shock resistance	Conforming to IEC 60068-2-27	50 gn, duration 11 ms	
Output state indication		Yellow LED: 4 viewing ports at 90°	Yellow LED: annular
Rated supply voltage		V	--- 12...48 non polarised for XS5●●B1● --- 12...24 non polarised for XS5●●BS (except Ø 6.5 short and Ø 8 short: polarised) with protection against reverse polarity
Voltage limits (including ripple)		V	--- 10...58 for XS5●●B1● --- 10...36 for XS5●●BS
Switching capacity		mA	1.5...100 with overload and short-circuit protection
Voltage drop, closed state		V	≤ 4.2
Residual current, open state		mA	≤ 0.5
Maximum switching frequency	XS506, XS508	Hz	1000 for XS5●●BS, 1400 for XS5●●B1●
	XS512	Hz	1000
	XS518	Hz	1200
	XS530	Hz	1300
Delays	First-up	ms	≤ 10
	Response	ms	≤ 0.5: XS506, XS508 and XS512 ≤ 0.6: XS518 ≤ 0.6: XS530
	Recovery	ms	≤ 0.2 (except XS530 ≤ 0.4)

(1) For PUR cable, replace the letter L in the reference by P. Example: XS506BSCAL2 becomes XS506BSCAP2 with a PUR cable.

Inductive proximity sensors

XS range, general purpose

Cylindrical, standard range, flush mountable

Two-wire DC

Wiring schemes

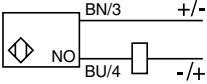
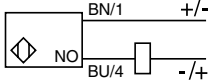
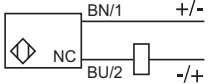
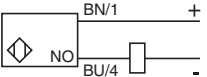
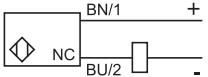
Connector	Pre-cabled	2-wire $\overline{\overline{\text{---}}}$ non polarised		
M12 	BU: Blue BN: Brown	NO output XS5●●B●DA●●●		NC output XS5●●B●DB●●●
				
		2-wire $\overline{\overline{\text{---}}}$ polarised		
		NO output XS5●●BSCA●●●		NC output XS5●●BSCB●●●
				

Remote connectors L01B, L01C, L01G, U78

Screw terminal (L01B)

The terminal numbering differs according to the version (2-wire $\overline{\overline{\text{---}}}$, 3-wire $\overline{\overline{\text{---}}}$, 2-wire $\overline{\overline{\text{~}}}$).

EN 175301-803-A (L01C)

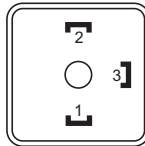

The NO or NC outputs are connected to terminal 2.

M18 (L01G)

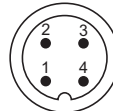

7/8" (U78)

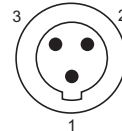

Terminal 1: not connected
Terminal 2: +/-
Terminal 3: +/-

Setting-up

Minimum mounting distances (mm)

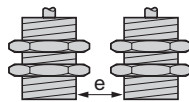

Side by side

∅ 6.5	$e \geq 3$
∅ 8	$e \geq 3$
∅ 12	$e \geq 4$
∅ 18	$e \geq 10$
∅ 30	$e \geq 20$

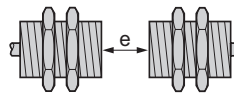

Face to face

$e \geq 18$
$e \geq 18$
$e \geq 24$
$e \geq 60$
$e \geq 120$

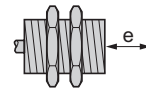

Facing a metal object

$e \geq 4.5$
$e \geq 4.5$
$e \geq 6$
$e \geq 15$
$e \geq 30$

Dimensions

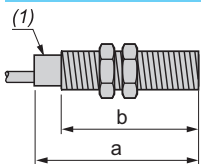

(1) LED

Sensors		Pre-cabled (mm)		M8 connector (mm)		M12 connector (mm)	
Short case model		a	b	a	b	a	b
∅ 6.5	XS506BS	33	–	42	–	45	–
∅ 8	XS508BS	33	25	42	26	45	24
∅ 12	XS512BS	35	25	–	–	50	30
∅ 18	XS518BS	40	28	–	–	50	28
∅ 30	XS530BS	44	32	–	–	55	32
Sensors		Pre-cabled (mm)		M12 connector (mm)			
Long case model		a	b	a	b		
∅ 8	XS508B1	51	42	62	40		
∅ 12	XS512B1	54	42	61	42		
∅ 18	XS518B1	56	44	64	44		
∅ 30	XS530B1	54	42	72	41		

Inductive proximity sensors

XS range, general purpose

Cylindrical, standard range, flush mountable

Two-wire AC or DC ⁽¹⁾

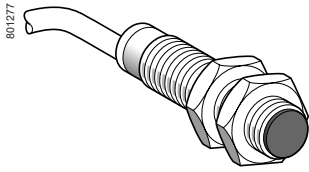

XS512B1M●L2

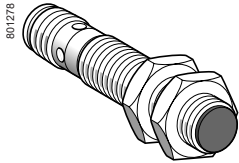

XS512B1M●U20

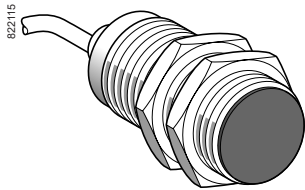

XS530B1●●L2

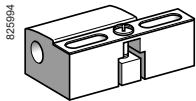

XSZB1●●

Sensors, 2-wire ~ 24-240 V, long case model

Ø 12, threaded M12 x 1

Sensing distance (Sn) mm	Function	Connection	Reference	Weight kg
2	NO	Pre-cabled (L = 2 m) (2)	XS512B1MAL2	0.075
		1/2"-20 UNF connector	XS512B1MAU20	0.025
	NC	Pre-cabled (L = 2 m) (2)	XS512B1MBL2	0.075
		1/2"-20 UNF connector	XS512B1MBU20	0.025

Ø 18, threaded M18 x 1

Sensing distance (Sn) mm	Function	Connection	Reference	Weight kg
5	NO	Pre-cabled (L = 2 m) (2)	XS518B1MAL2	0.100
		1/2"-20 UNF connector	XS518B1MAU20	0.060
	NC	Pre-cabled (L = 2 m) (2)	XS518B1MBL2	0.100
		1/2"-20 UNF connector	XS518B1MBU20	0.060

Ø 30, threaded M30 x 1.5

Sensing distance (Sn) mm	Function	Connection	Reference	Weight kg
10	NO	Pre-cabled (L = 2 m) (2)	XS530B1MAL2	0.205
		1/2"-20 UNF connector	XS530B1MAU20	0.145
	NC	Pre-cabled (L = 2 m) (2)	XS530B1MBL2	0.205
		1/2"-20 UNF connector	XS530B1MBU20	0.145

Accessories ⁽³⁾

Description	For use with sensors	Reference	Weight kg
Fixing clamps	Ø 12	XSZB112	0.006
	Ø 18	XSZB118	0.010
	Ø 30	XSZB130	0.020

(1) Ø8 plastic, double insulation version available (see page 64).

(2) For a 5 m cable replace L2 by L5; for a 10 m cable replace L2 by L10. Please consult our Customer Care Centre for availability.

Example: **XS512B1MAL2** becomes **XS512B1MAL5** with a 5 m cable.

(3) For more information, see page 118.

Inductive proximity sensors

XS range, general purpose

Cylindrical, standard range, flush mountable

Two-wire AC or DC

Characteristics		XS5●●B1M●U20	XS5●●B1M●L2
Sensor type			
Product certifications		UL, CSA, CE	
Connection	Connector	1/2"-20 UNF	
	Pre-cabled	-	
Operating zone	Ø 12	mm	0...1.6
	Ø 18	mm	0...4
	Ø 30	mm	0...8
Differential travel		%	
		1...15 of effective sensing distance (Sr)	
Degree of protection	Conforming to IEC 60529	IP 65 and IP 67	
	Conforming to DIN 40050	IP 69K	
Storage temperature		°C	
		-40...+85	
Operating temperature		°C	
		-25...+70	
Materials	Case	Nickel plated brass	
	Sensing face	PPS	
	Cable	-	
		PvR 2 x 0.34 mm ²	
Vibration resistance	Conforming to IEC 60068-2-6	25 gn, amplitude ± 2 mm (f = 10 to 55 Hz)	
Shock resistance	Conforming to IEC 60068-2-27	50 gn, duration 11 ms	
Output state indication		Yellow LED: 4 viewing ports at 90°	
		Yellow LED: annular	
Rated supply voltage		V	
		~ or --- 24...240 (~ 50/60 Hz)	
Voltage limits (including ripple)		V	
		~ or --- 20...264	
Switching capacity	XS512B1M●●●	mA	5...200 (1)
	XS518B1M●●●, XS530B1M●●●	mA	~ 5...300 or --- 5...200 (1)
Voltage drop, closed state		V	
		≤ 5.5	
Residual current, open state		mA	
		≤ 0.8	
Maximum switching frequency	XS512B1●●●, XS518B1M●●●	Hz	~ 25 or --- 1000
	XS530B1M●●●	Hz	~ 25 or --- 500
Delays	First-up	ms	≤ 20 XS512B1M●●●
			≤ 25 XS518B1M●●● and XS530B1M●●●
	Response	ms	≤ 0.5
Recovery	ms	≤ 0.2 XS512B1M●●●	
		≤ 0.5 XS518B1M●●●	
			≤ 2 XS518B1M●●●

(1) It is essential to connect a 0.4 A "quick-blow" fuse in series with the load.

Wiring schemes

Connector	Pre-cabled	2-wire ~ or ---
1/2"-20 UNF	BU: Blue BN: Brown	NO or NC output
		⊕: on connector models only

Setting-up

Minimum mounting distances (mm)

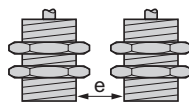

Sensor	Side by side
Ø 12	e ≥ 8
Ø 18	e ≥ 16
Ø 30	e ≥ 30

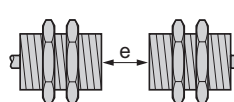

Sensor	Face to face
Ø 12	e ≥ 48
Ø 18	e ≥ 100
Ø 30	e ≥ 180

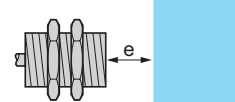

Sensor	Facing a metal object
Ø 12	e ≥ 12
Ø 18	e ≥ 25
Ø 30	e ≥ 45

Dimensions

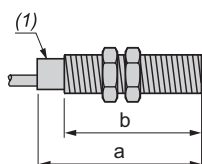

(1) LED

Sensor	XS6		Connector (mm)	
	Pre-cabled (mm)		a	b
XS512B1M	a	b	62	42
XS518B1M	62	52	73	52
XS530B1M	62	52	73	52

Inductive proximity sensors

XS range, general purpose

Cylindrical, increased range, flush mountable

Three-wire DC, solid-state output

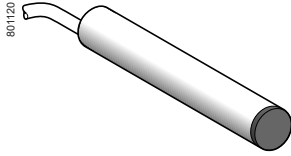

XS106B3●●L2

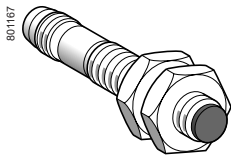

XS108B3●●M8

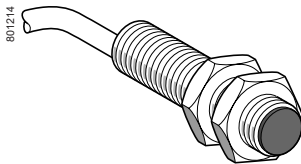

XS112B3●●L2

Sensors, 3-wire 12-24 V, short case model

Sensing distance (Sn) mm	Function	Output	Connection	Sold in lots of	Unit reference	Weight kg			
Ø 6.5, plain									
2.5	NO	PNP	Pre-cabled (L = 2 m) (1)	1	XS106B3PAL2	0.060			
			M8 connector	1	XS106B3PAM8	0.030			
			M12 connector	1	XS106B3PAM12	0.050			
		Pre-cabled (L = 2 m)	20	XS106B3PAL2TQ	0.980				
		M8 connector	20	XS106B3PAM8TQ	0.320				
		NPN	Pre-cabled (L = 2 m)	1	XS106B3NAL2	0.060			
	NC	PNP	Pre-cabled (L = 2 m) (1)	1	XS106B3PBL2	0.060			
			M8 connector	1	XS106B3PBM8	0.030			
			NPN	Pre-cabled (L = 2 m) (1)	1	XS106B3NBL2	0.060		
		M8 connector	1	XS106B3NBM8	0.030				
			Ø 8, threaded M8 x 1						
			2.5	NO	PNP	Pre-cabled (L = 2 m) (1)	1	XS108B3PAL2	0.070
M8 connector	1	XS108B3PAM8				0.030			
M12 connector	1	XS108B3PAM12				0.060			
Pre-cabled (L = 2 m)	20	XS108B3PAL2TQ			1.120				
M8 connector	20	XS108B3PAM8TQ			0.460				
M12 connector	20	XS108B3PAM12TQ			0.940				
NC	PNP	Pre-cabled (L = 2 m) (1)		1	XS108B3NAL2	0.070			
		M8 connector		1	XS108B3NAM8	0.030			
		M12 connector		1	XS108B3NAM12	0.060			
	Pre-cabled (L = 2 m)	20		XS108B3NAL2TQ	1.120				
	M8 connector	20		XS108B3NAM8TQ	0.460				
	NPN	Pre-cabled (L = 2 m) (1)		1	XS108B3NBL2	0.070			
M8 connector		1	XS108B3NBM8	0.030					
M12 connector		1	XS108B3NBM12	0.060					
Ø 12, threaded M12 x 1									
4	NO	PNP	Pre-cabled (L = 2 m) (1)	1	XS112B3PAL2	0.090			
			M12 connector	1	XS112B3PAM12	0.030			
			Pre-cabled (L = 2 m)	20	XS112B3PAL2TQ	1.600			
		M12 connector	20	XS112B3PAM12TQ	0.470				
		NPN	Pre-cabled (L = 2 m) (1)	1	XS112B3NAL2	0.090			
		M12 connector	1	XS112B3NAM12	0.030				
	NC	PNP	Pre-cabled (L = 2 m)	20	XS112B3NAL2TQ	1.600			
			M12 connector	20	XS112B3NAM12TQ	0.470			
			Pre-cabled (L = 2 m) (1)	1	XS112B3PBL2	0.090			
		M12 connector	1	XS112B3PBM12	0.030				
		M12 connector	20	XS112B3PBM12TQ	0.470				
		NPN	Pre-cabled (L = 2 m) (1)	1	XS112B3NBL2	0.090			
M12 connector	1		XS112B3NBM12	0.030					

(1) For a 5 m long cable replace L2 by L5. Please consult our Customer Care Centre for availability.

Example: XS106B3PAL2 becomes XS106B3PAL5 with a 5 m cable.

Inductive proximity sensors

XS range, general purpose

Cylindrical, increased range, flush mountable

Three-wire DC, solid-state output

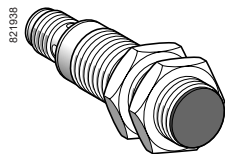

XS118B3●●M12

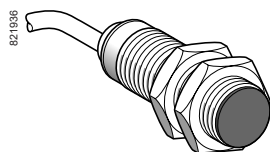

XS118B3●●L2

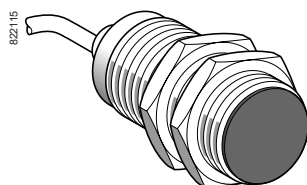

XS130B3●●L2

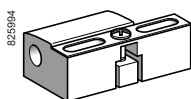

XSZB1●●

Sensors, 3-wire 12-24 V, short case model (continued)

Sensing distance (Sn) mm	Function	Output	Connection	Sold in lots of	Unit reference	Weight kg
Ø 18, threaded M18 x 1						
8	NO	PNP	Pre-cabled (L = 2 m) (1)	1	XS118B3PAL2	0.110
			M12 connector	1	XS118B3PAM12	0.060
	NPN	Pre-cabled (L = 2 m) (1)	20	XS118B3PAL2TQ	2.000	
			M12 connector	20	XS118B3PAM12TQ	1.140
		Pre-cabled (L = 2 m) (1)	1	XS118B3NAL2	0.110	
			M12 connector	1	XS118B3NAM12	0.060
NC	PNP	Pre-cabled (L = 2 m) (1)	20	XS118B3NAL2TQ	2.000	
			M12 connector	20	XS118B3NAM12TQ	1.140
	NPN	Pre-cabled (L = 2 m) (1)	1	XS118B3PBL2	0.110	
			M12 connector	1	XS118B3PBM12	0.060
		Pre-cabled (L = 2 m) (1)	1	XS118B3NBL2	0.110	
			M12 connector	1	XS118B3NBM12	0.060
Ø 30, threaded M30 x 1.5						
15	NO	PNP	Pre-cabled (L = 2 m) (1)	1	XS130B3PAL2	0.180
			M12 connector	1	XS130B3PAM12	0.130
	NPN	Pre-cabled (L = 2 m) (1)	20	XS130B3PAL2TQ	3.360	
			M12 connector	20	XS130B3PAM12TQ	2.000
		Pre-cabled (L = 2 m) (1)	1	XS130B3NAL2	0.180	
			M12 connector	1	XS130B3NAM12	0.130
NC	PNP	Pre-cabled (L = 2 m) (1)	20	XS130B3NAM12TQ	2.000	
			M12 connector	1	XS130B3PBL2	0.180
	NPN	Pre-cabled (L = 2 m) (1)	1	XS130B3PBM12	0.130	
			M12 connector	1	XS130B3PBM12	0.130
		Pre-cabled (L = 2 m) (1)	1	XS130B3NBL2	0.180	
			M12 connector	1	XS130B3NBM12	0.130

Accessories (2)

Description	For use with sensors	Reference	Weight kg
Fixing clamps	Ø 6.5 (plain)	XSZB165	0.005
	Ø 8 (M8 x1)	XSZB108	0.006
	Ø 12 (M12 x1)	XSZB112	0.006
	Ø 18 (M18 x1)	XSZB118	0.010
	Ø 30 (M30 x 1.5)	XSZB130	0.020

(1) For a 5 m cable, replace L2 by L5. Please consult our Customer Care Centre for availability.
Example: XS118B3PAL2 becomes XS118B3PAL5 with a 5 m cable.

(2) For more information, see page 118.

Inductive proximity sensors

XS range, general purpose

Cylindrical, increased range, flush mountable

Three-wire DC, solid-state output

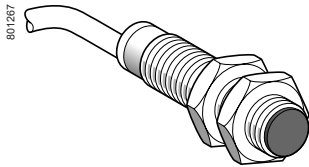

XS600B100L2

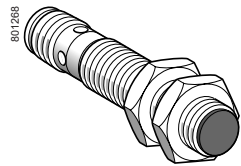

XS600B100M12

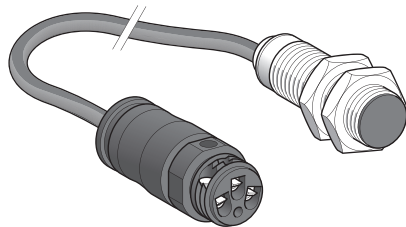

XS600B100L01B (2)

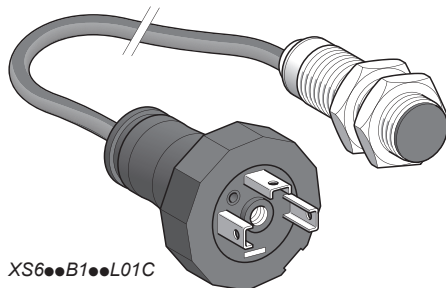

XS600B100L01C

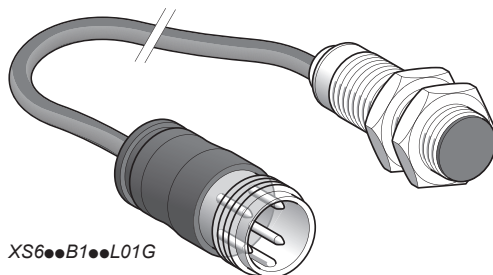

XS600B100L01G

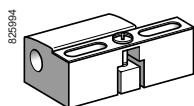

XSZB000

Sensors, 3-wire 12-48 V, long case model

Sensing distance (Sn) mm	Function	Output	Connection	Reference	Weight kg
Ø 8, threaded M8 x 1					
2.5	NO	PNP	Pre-cabled (L = 2 m) (1)	XS608B1PAL2	0.035
			M8 connector	XS608B1PAM8	0.015
			M12 connector	XS608B1PAM12	0.015
		NPN	Pre-cabled (L = 2 m) (1)	XS608B1NAL2	0.035
			M8 connector	XS608B1NAM8	0.015
			M12 connector	XS608B1NAM12	0.015
	NC	PNP	Pre-cabled (L = 2 m) (1)	XS608B1PBL2	0.035
			M8 connector	XS608B1PBM8	0.015
			M12 connector	XS608B1PBM12	0.015
		NPN	Pre-cabled (L = 2 m) (1)	XS608B1NBL2	0.035
			M8 connector	XS608B1NBM8	0.015
			M12 connector	XS608B1NBM12	0.015
Ø 12, threaded M12 x 1					
4	NO	PNP	Pre-cabled (L = 2 m) (1)	XS612B1PAL2	0.075
			M12 connector	XS612B1PAM12	0.020
			M12 connector	XS612B1NAM12	0.020
		NPN	Pre-cabled (L = 2 m) (1)	XS612B1NAL2	0.075
			M12 connector	XS612B1NAM12	0.020
			M12 connector	XS612B1NAM12	0.020
	NC	PNP	Pre-cabled (L = 2 m) (1)	XS612B1PBL2	0.075
			M12 connector	XS612B1PBM12	0.020
			M12 connector	XS612B1PBM12	0.020
		NPN	Pre-cabled (L = 2 m) (1)	XS612B1NBL2	0.075
			M12 connector	XS612B1NBM12	0.020
			M12 connector	XS612B1NBM12	0.020
Ø 18, threaded M18 x 1					
8	NO	PNP	Pre-cabled (L = 2 m) (1)	XS618B1PAL2	0.100
			M12 connector	XS618B1PAM12	0.040
			Remote screw terminal connector	XS618B1PAL01B (2)	0.100
			Remote EN 175301-803-A connector	XS618B1PAL01C	0.100
			Remote M18 connector	XS618B1PAL01G	0.100
			M12 connector	XS618B1NAM12	0.040
		NPN	Pre-cabled (L = 2 m) (1)	XS618B1NAL2	0.100
			M12 connector	XS618B1NAM12	0.040
			Remote screw terminal connector	XS618B1NAL01B (2)	0.100
			Remote M18 connector	XS618B1NAL01G	0.100
			M12 connector	XS618B1NAM12	0.040
			M12 connector	XS618B1NAM12	0.040
	NC	PNP	Pre-cabled (L = 2 m) (1)	XS618B1PBL2	0.100
			M12 connector	XS618B1PBM12	0.040
			Remote screw terminal connector	XS618B1PBL01B (2)	0.100
			Remote M18 connector	XS618B1PBL01G	0.100
			M12 connector	XS618B1PBM12	0.040
			M12 connector	XS618B1PBM12	0.040
		NPN	Pre-cabled (L = 2 m) (1)	XS618B1NBL2	0.100
			M12 connector	XS618B1NBM12	0.040
			Remote screw terminal connector	XS618B1NBL01B (2)	0.100
			Remote M18 connector	XS618B1NBL01G	0.100
			M12 connector	XS618B1NBM12	0.040
			M12 connector	XS618B1NBM12	0.040
Ø 30, threaded M30 x 1.5					
15	NO	PNP	Pre-cabled (L = 2 m) (1)	XS630B1PAL2	0.205
			M12 connector	XS630B1PAM12	0.145
			Remote screw terminal connector	XS630B1PAL01B (2)	0.205
			Remote EN 175301-803-A connector	XS630B1PAL01C	0.205
			Remote M18 connector	XS630B1PAL01G	0.205
			M12 connector	XS630B1NAM12	0.145
		NPN	Pre-cabled (L = 2 m) (1)	XS630B1NAL2	0.205
			M12 connector	XS630B1NAM12	0.145
			Remote screw terminal connector	XS630B1NAL01B (2)	0.205
			Remote M18 connector	XS630B1NAL01G	0.205
			M12 connector	XS630B1NAM12	0.145
			M12 connector	XS630B1NAM12	0.145
	NC	PNP	Pre-cabled (L = 2 m) (1)	XS630B1PBL2	0.205
			M12 connector	XS630B1PBM12	0.145
			Remote EN 175301-803-A connector	XS630B1PBL01C	0.205
			Remote M18 connector	XS630B1PBL01G	0.205
			M12 connector	XS630B1PBM12	0.145
			M12 connector	XS630B1PBM12	0.145
		NPN	Pre-cabled (L = 2 m) (1)	XS630B1NBL2	0.205
			M12 connector	XS630B1NBM12	0.145
			Remote EN 175301-803-A connector	XS630B1NBL01C	0.205
			Remote M18 connector	XS630B1NBL01G	0.205
			M12 connector	XS630B1NBM12	0.145
			M12 connector	XS630B1NBM12	0.145

Accessories (3)

Description	For use with sensors	Reference	Weight kg
Fixing clamps	Ø 8	XSZB108	0.006
	Ø 12	XSZB112	0.006
	Ø 18	XSZB118	0.010
	Ø 30	XSZB130	0.020

(1) For a 5 m long cable replace L2 by L5; for a 10 m long cable replace L2 by L10. Please consult our Customer Care Centre for availability.

Example: XS608B1PAL2 becomes XS608B1PAL5 with a 5 m cable.

(2) Protective cable gland included with sensor.

(3) For more information, see page 118.

Inductive proximity sensors

XS range, general purpose

Cylindrical, increased range, flush mountable

Three-wire DC, solid-state output

Characteristics		XS1/XS6●●B●●M8	XS1/XS6●●B●●M12	XS1/XS6●●B●●L2
Sensor type		UL, CSA, CE, E2		
Product certifications		UL, CSA, CE, E2		
Connection	Connector	M8	M12	–
	Pre-cabled	–	–	Length 2 m
	Remote connector	Screw terminal (L01B), EN 175301-803-A (L01C) and M18 (L01G) remote connectors on 0.15 m flying lead		
Operating zone (1)	Ø 6.5 and Ø 8	mm	0...2	
	Ø 12	mm	0...3.2	
	Ø 18	mm	0...6.4	
	Ø 30	mm	0...12	
Differential travel		% 1...15 of effective sensing distance (Sr)		
Degree of protection	Conforming to IEC 60529	IP 65 and IP 67		IP 65 and IP 68, double insulation  except Ø 6.5 and Ø 8: IP 67
	Conforming to DIN 40050	IP 69K		
Storage temperature		°C -40...+85		
Operating temperature		°C -25...+70		
Materials	Case	Nickel plated brass (except Ø 6.5 and Ø 8: stainless steel, grade 303)		
	Sensing face	PPS		
	Cable	–		PvR 3 x 0.34 mm ² except Ø 6.5 and 8: 3 x 0.11 mm ²
Vibration resistance	Conforming to IEC 60068-2-6	25 gn, amplitude ± 2 mm (f = 10 to 55 Hz)		
Shock resistance	Conforming to IEC 60068-2-27	50 gn, duration 11 ms		
Output state indication		Yellow LED, 4 viewing ports at 90°		Yellow LED, annular
Rated supply voltage		V XS1: ≍ 12...24 with protection against reverse polarity XS6: ≍ 12...48 with protection against reverse polarity		
Voltage limits (including ripple)		V XS1: ≍ 10...36; XS6: ≍ 10...58		
Switching capacity		mA ≤ 200 with overload and short-circuit protection		
Voltage drop, closed state		V ≤ 2		
Current consumption, no-load		mA ≤ 10		
Maximum switching frequency	Ø 6.5, Ø 8 and Ø 12	Hz	2500	
	Ø 18	Hz	1000	
	Ø 30	Hz	500	
Delays	First-up	ms	≤ 10	
	Response	ms	≤ 0.2 for Ø 6.5, Ø 8 and Ø 12, ≤ 0.3 for Ø 18, ≤ 0.6 for Ø 30	
	Recovery	ms	≤ 0.2 for Ø 6.5, Ø 8 and Ø 12, ≤ 0.7 for Ø 18, ≤ 1.4 for Ø 30	

(1) Detection curves, see page 122.

Wiring schemes

Connector (1)

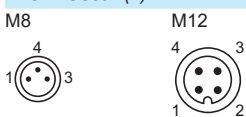

Pre-cabled

BU: Blue
BN: Brown
BK: Black

PNP

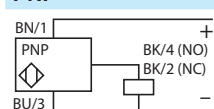

NPN

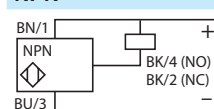

For M8 connector, NO and NC outputs on terminal 4

Setting-up

Minimum mounting distances (mm)

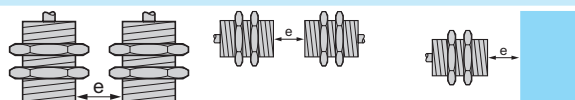

Sensors	Side by side	Face to face	Facing a metal object
Ø 6.5	e ≥ 5	e ≥ 30	e ≥ 8
Ø 8	e ≥ 5	e ≥ 30	e ≥ 8
Ø 12	e ≥ 8	e ≥ 48	e ≥ 12
Ø 18	e ≥ 16	e ≥ 100	e ≥ 25
Ø 30	e ≥ 30	e ≥ 180	e ≥ 45

(1) For pin arrangement of remote connectors L01B, L01C and L01G, see page 29.

Dimensions

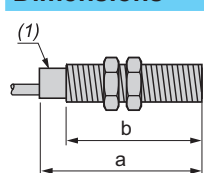

(1) LED

Sensors		Pre-cabled (mm)		M8 connector (mm)		M12 connector (mm)	
Short case model		a	b	a	b	a	b
Ø 6.5	XS106B3	34	–	42	–	45	–
Ø 8	XS108B3	34	25	42	27	45	23
Ø 12	XS112B3	35	25	–	–	50	30
Ø 18	XS118B3	39	28	–	–	50	28
Ø 30	XS130B3	43	32	–	–	55	32

Sensors		Pre-cabled (mm)		M8 connector (mm)		M12 connector (mm)	
Long case model		a	b	a	b	a	b
Ø 8	XS608B1	51	42	58	43	61	40
Ø 12	XS612B1	53	42	–	–	61	42
Ø 18	XS618B1	62	52	–	–	74	52
Ø 30	XS630B1	62	52	–	–	74	52

Inductive proximity sensors

XS range, general purpose

Cylindrical, increased range, flush mountable

Two-wire DC, solid-state output

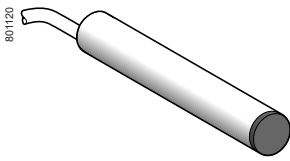

XS606B3●●L2

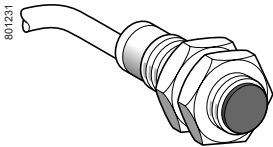

XS612B3●●L2

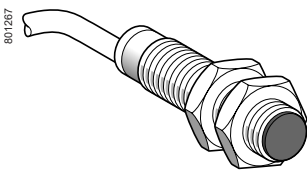

XS6●●B1●●L2

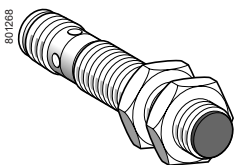

XS6●●B1●●M12

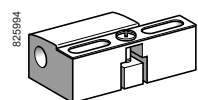

XSZB1●●

Sensors, 2-wire 12-24 V, short case model

Sensing distance (Sn) mm	Function	Connection	Reference	Weight kg
Ø 6.5, plain				
2.5	NO	Pre-cabled (L = 2 m) (1)	XS606B3CAL2	0.060
		Remote M12 connector	XS606B3CAL01M12	0.070
	NC	Pre-cabled (L = 2 m) (1)	XS606B3CBL2	0.060
Ø 8, threaded M8 x 1				
2.5	NO	Pre-cabled (L = 2 m) (1)	XS608B3CAL2	0.070
		Remote M12 connector	XS608B3CAL01M12	0.070
	NC	Pre-cabled (L = 2 m) (1)	XS608B3CBL2	0.070
		Remote M12 connector	XS608B3CBL01M12	0.070
Ø 12, threaded M12 x 1				
4	NO	Pre-cabled (L = 2 m) (1)	XS612B3DAL2	0.090
		M12 connector	XS612B3DAM12	0.030
	NC	Pre-cabled (L = 2 m) (1)	XS612B3DBL2	0.090
		M12 connector	XS612B3DBM12	0.030
Ø 18, threaded M18 x 1				
8	NO	Pre-cabled (L = 2 m) (1)	XS618B3DAL2	0.110
		M12 connector	XS618B3DAM12	0.060
	NC	Pre-cabled (L = 2 m) (1)	XS618B3DBL2	0.110
		M12 connector	XS618B3DBM12	0.060
Ø 30, threaded M30 x 1.5				
15	NO	Pre-cabled (L = 2 m) (1)	XS630B3DAL2	0.180
		M12 connector	XS630B3DAM12	0.130
	NC	Pre-cabled (L = 2 m) (1)	XS630B3DBL2	0.180
		M12 connector	XS630B3DBM12	0.180

Sensors, 2-wire 12-48 V, long case model

Sensing distance (Sn) mm	Function	Connection	Reference	Weight kg
Ø 6.5, plain				
2.5	NO	Pre-cabled (L = 2 m) (1)	XS606B1DAL2	0.060
		Pre-cabled (L = 2 m) (1)	XS606B1DBL2	0.060
Ø 8, threaded M8 x 1				
2.5	NO	Pre-cabled (L = 2 m) (1)	XS608B1DAL2	0.035
		M12 connector	XS608B1DAM12	0.015
	NC	Pre-cabled (L = 2 m) (1)	XS608B1DBL2	0.035
		M12 connector	XS608B1DBM12	0.015
Ø 12, threaded M12 x 1				
4	NO	Pre-cabled (L = 2 m) (1)	XS612B1DAL2	0.180
		M12 connector	XS612B1DAM12	0.020
	NC	Pre-cabled (L = 2 m) (1)	XS612B1DBL2	0.075
		M12 connector	XS612B1DBM12	0.020
Ø 18, threaded M18 x 1				
8	NO	Pre-cabled (L = 2 m) (1)	XS618B1DAL2	0.100
		M12 connector	XS618B1DAM12	0.040
	NC	Pre-cabled (L = 2 m) (1)	XS618B1DBL2	0.100
		M12 connector	XS618B1DBM12	0.040
Ø 30, threaded M30 x 1.5				
15	NO	Pre-cabled (L = 2 m) (1)	XS630B1DAL2	0.205
		M12 connector	XS630B1DAM12	0.145
	NC	Pre-cabled (L = 2 m) (1)	XS630B1DBL2	0.205
		M12 connector	XS630B1DBM12	0.145

Accessories (2)

Description	For use with sensors	Reference	Weight kg
Fixing clamps	Ø 6.5 (plain)	XSZB165	0.005
	Ø 8 (M8 x1)	XSZB108	0.006
	Ø 12 (M12 x1)	XSZB112	0.006
	Ø 18 (M18 x1)	XSZB118	0.010
	Ø 30 (M30 x 1.5)	XSZB130	0.020

(1) For a 5 m cable, replace L2 by L5. Please consult our Customer Care Centre for availability.
Example: XS606B3CAL2 becomes XS606B3CAL5 with a 5 m cable.

(2) For more information, see page 118.

Inductive proximity sensors

XS range, general purpose

Cylindrical, increased range, flush mountable

Two-wire DC, solid-state output

Characteristics

Sensor type		XS6●●B3●●M12 XS6●●B1D●M12	XS6●●B3●●L2 XS6●●B1D●L2
Product certifications		UL, CSA, CE	
Connection	Connector	M12 or remote M12 connector (L01M12) on 0.15 m flying lead	
	Pre-cabled	Length 2 m	
Operating zone (1)	Ø 6.5 and Ø 8	mm	0... 2
	Ø 12	mm	0...3.2
	Ø 18	mm	0...6.4
	Ø 30	mm	0...12
Differential travel		%	1...15 of effective sensing distance (Sr)
Degree of protection	Conforming to IEC 60529	IP 65 and IP 67	
	Conforming to DIN 40050	IP 69K	
Storage temperature		°C	-40...+85
Operating temperature		°C	-25...+70
Materials	Case	Nickel plated brass (except XS606B1D or XS608B1D: stainless steel, grade 303)	
	Sensing face	PPS	
	Cable	PvR 2 x 0.34 mm ² except Ø 6.5 and Ø 8: 2 x 0.11 mm ²	
Vibration resistance	Conforming to IEC 60068-2-6	25 gn, amplitude ± 2 mm (f = 10 to 55 Hz)	
Shock resistance	Conforming to IEC 60068-2-27	50 gn, duration 11 ms	
Output state indication		Yellow LED, 4 viewing ports at 90°	
Rated supply voltage		V	--- 12...48 non polarised for XS6●●B1D --- 12...24 non polarised for XS6●●B3● (except Ø 6.5 short and Ø 8 short: polarised), with protection against reverse polarity
Voltage limits (including ripple)		V	--- 10...58 for XS6●●B1D --- 10...36 for XS6●●B3●
Switching capacity		mA	≤ 100 with overload and short-circuit protection
Voltage drop, closed state		V	≤ 4.2
Residual current, open state		mA	≤ 0.5 mA
Maximum switching frequency	Ø 6.5, Ø 8	Hz	1400 for XS6●●B1D, 1100 for XS6●●B3●
	Ø 12	Hz	1300
	Ø 18	Hz	1500
	Ø 30	Hz	800
Delays	First-up	ms	≤ 10
	Response	ms	≤ 0.5
	Recovery	ms	≤ 0.2 for Ø 6.5, Ø 8 and Ø 12; 0.3 for Ø 18; 0.6 for Ø 30

(1) Detection curves, see page 122.

Wiring schemes

M12 connector



Pre-cabled

BU: Blue
BN: Brown

2-wire --- non polarised

NO output

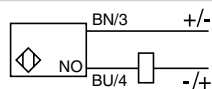

NC output

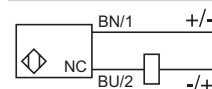

2-wire --- polarised

XS6●●B3CA

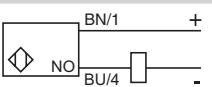

XS6●●B3CB

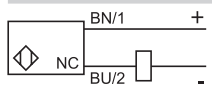

Setting-up

Minimum mounting distances (mm)

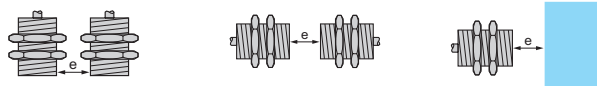

Sensors	Side by side	Face to face	Facing a metal object
Ø 6.5	e ≥ 5	e ≥ 30	e ≥ 8
Ø 8	e ≥ 5	e ≥ 30	e ≥ 8
Ø 12	e ≥ 8	e ≥ 48	e ≥ 12
Ø 18	e ≥ 16	e ≥ 100	e ≥ 25
Ø 30	e ≥ 30	e ≥ 180	e ≥ 45

Dimensions

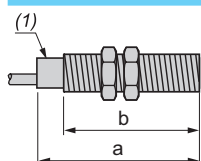

(1) LED

Sensors		Pre-cabled (mm)		M12 connector (mm)	
Short case model		a	b	a	b
Ø 6.5	XS606B3C	33	–	–	–
Ø 8	XS608B3C	33	25	–	24
Ø 12	XS612B3D	35	25	50	30
Ø 18	XS618B3D	40	28	50	28
Ø 30	XS630B3D	44	32	55	32
Long case model		a	b	a	b
Ø 6.5	XS606B1D	50	–	–	–
Ø 8	XS608B1D	51	42	62	40
Ø 12	XS612B1D	53	42	61	42
Ø 18	XS618B1D	62	52	74	52
Ø 30	XS630B1D	62	52	74	52

Inductive proximity sensors

XS range, general purpose

Cylindrical, increased range, flush mountable

Two-wire AC or DC ⁽¹⁾

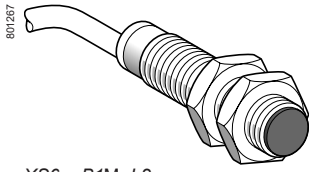

XS612B1MAL2

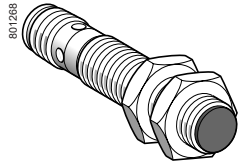

XS618B1MAL2

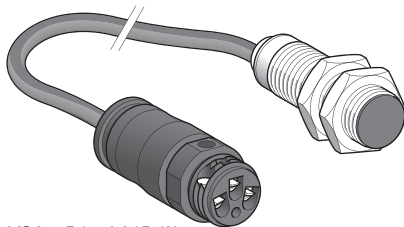

XS630B1MAL2

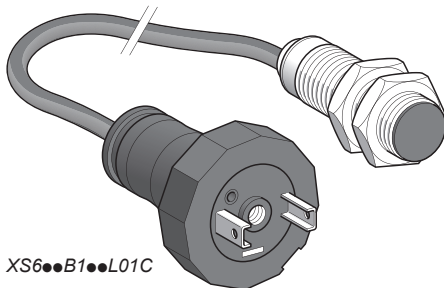

XS612B1MBL2

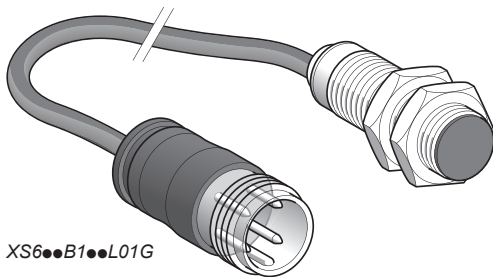

XS618B1MBL2

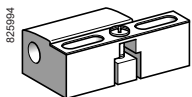

XSZB112

Sensors, 2-wire ~ 24-240 V, long case model

Sensing distance (Sn) mm	Function	Connection	Reference	Weight kg
Ø 12, threaded M12 x 1				
4	NO	Pre-cabled (L = 2 m) (2)	XS612B1MAL2	0.075
		1/2"-20 UNF connector	XS612B1MAU20	0.025
	NC	Pre-cabled (L = 2 m) (2)	XS612B1MBL2	0.075
		1/2"-20 UNF connector	XS612B1MBU20	0.025

Ø 18, threaded M18 x 1				
8	NO	Pre-cabled (L = 2 m) (2)	XS618B1MAL2	0.100
		1/2"-20 UNF connector	XS618B1MAU20	0.060
		Remote screw terminal connector	XS618B1MAL01B (3)	0.100
		Remote EN 175301-803-A connector	XS618B1MAL01C	0.100
	NC	Pre-cabled (L = 2 m) (2)	XS618B1MBL2	0.100
		1/2"-20 UNF connector	XS618B1MBU20	0.060
		Remote screw terminal connector	XS618B1MBL01B (3)	0.100
		Remote EN 175301-803-A connector	XS618B1MBL01C	0.100
		Remote M18 connector	XS618B1MBL01G	0.100

Ø 30, threaded M30 x 1.5				
15	NO	Pre-cabled (L = 2 m) (2)	XS630B1MAL2	0.205
		1/2"-20 UNF connector	XS630B1MAU20	0.145
		Remote screw terminal connector	XS630B1MAL01B (3)	0.205
		Remote EN 175301-803-A connector	XS630B1MAL01C	0.205
	NC	Pre-cabled (L = 2 m) (2)	XS630B1MBL2	0.205
		1/2"-20 UNF connector	XS630B1MBU20	0.145
		Remote screw terminal connector	XS630B1MBL01B (3)	0.205
		Remote EN 175301-803-A connector	XS630B1MBL01C	0.205
		Remote M18 connector	XS630B1MBL01G	0.205

Accessories (4)

Description	For use with sensors	Reference	Weight kg
Fixing clamps	Ø 12	XSZB112	0.006
	Ø 18	XSZB118	0.010
	Ø 30	XSZB130	0.020

(1) Ø8 plastic, double insulation version available (see page 64).

(2) For a 5 m cable replace L2 by L5; for a 10 m cable replace L2 by L10. Please consult our Customer Care Centre for availability.

Example: XS612B1MAL2 becomes XS612B1MAL5 with a 5 m cable.

(3) Protective cable gland included with sensor.

(4) For more information, see page 118.

Inductive proximity sensors

XS range, general purpose

Cylindrical, increased range, flush mountable

Two-wire AC or DC

Characteristics		XS6●●B1M●U20	XS6●●B1M●L●
Sensor type		UL, CSA, C€	
Product certifications		UL, CSA, C€	
Connection	Connector	1/2" - 20 UNF	
	Pre-cabled	-	
	Remote connector	Screw terminal (L01B), EN 175301-803-A (L01C) and M18 (L01G) remote connectors on 0.15 m flying lead	
Operating zone (1)	Ø 12	mm	0... 3.2
	Ø 18	mm	0... 6.4
	Ø 30	mm	0... 12
Differential travel		%	
Degree of protection		1...15 of effective sensing distance (Sr)	
Degree of protection	Conforming to IEC 60529	IP 65, IP 67	
	Conforming to DIN 40050	IP 69K	
Storage temperature		°C -40...+85	
Operating temperature		°C -25...+70	
Materials	Case	Nickel plated brass	
	Sensing face	PPS	
	Cable	PvR 2 x 0.34 mm ²	
Vibration resistance	Conforming to IEC 60068-2-6	25 gn, amplitude ± 2 mm (f = 10 to 55 Hz)	
Shock resistance	Conforming to IEC 60068-2-27	50 gn, duration 11 ms	
Output state indication		Yellow LED: annular on pre-cabled version Yellow LED with 4 viewing ports at 90° on connector version	
Rated supply voltage		V \approx 24...240 (~ 50/60 Hz)	
Voltage limits (including ripple)		V \approx 20...264	
Switching capacity	XS612B1M●●●	mA 5...200 (2)	
	XS618B1M●●●	mA \sim 5...300 or \approx 5...200 (2)	
	XS630B1M●●●		
Voltage drop, closed state		V \leq 5.5	
Residual current, open state		mA \leq 0.8	
Maximum switching frequency (DC/AC)	Ø 12	Hz \approx 1000 / \sim 25	
	Ø 18	Hz \approx 1000 / \sim 25	
	Ø 30	Hz \approx 500 / \sim 25	
Delays	First-up	ms \leq 25 for Ø 18 and Ø 30; \leq 20 for Ø 12	
	Response	ms \leq 0.5	
	Recovery	ms \leq 0.2 for Ø 12; \leq 0.5 for Ø 18; \leq 2 for Ø 30	

(1) Detection curves, see page 122.

(2) It is essential to connect a 0.4 A "quick-blow" fuse in series with the load.

Wiring schemes

Connector (1)

1/2"-20 UNF



\sim : 2
±: 1
 \sim : 3

Pre-cabled

BU: Blue
BN: Brown

2-wire \sim or ---

NO or NC output

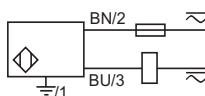

±: on 1/2"-20UNF connector models only

(1) For pin arrangement of remote connectors L01B, L01C and L01G, see page 29.

Setting-up

Minimum mounting distances (mm)

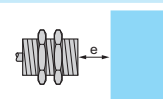
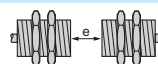
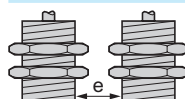

Sensors	Side by side	Face to face	Facing a metal object
Ø 12	e ≥ 8	e ≥ 48	e ≥ 12
Ø 18	e ≥ 16	e ≥ 100	e ≥ 25
Ø 30	e ≥ 30	e ≥ 180	e ≥ 45

Dimensions

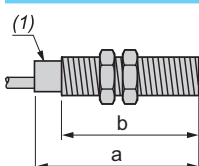

Sensors	Pre-cabled (mm)		Connector (mm)	
	a	b	a	b
Ø 12 XS612B1M●	53	42	61	42
Ø 18 XS618B1M●	62	52	73	52
Ø 30 XS630B1M●	62	52	73	52

(1) LED

Inductive proximity sensors

XS range, general purpose

Cylindrical, increased range, non flush mountable

Three-wire DC, solid-state output

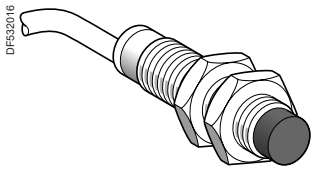

XS612B4●●L2

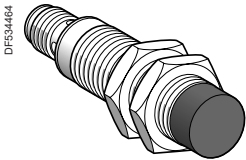

XS618B4●●M12

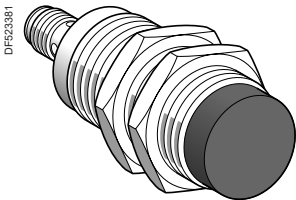

XS630B5●●M12

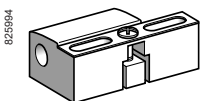

XSZB●●●

Sensors, 3-wire 12...48 V, long case model

Ø 8, threaded M8 x 1

Sensing distance (Sn) mm	Function	Output	Connection	Reference	Weight kg
4	NO	PNP	Pre-cabled (L = 2 m)	XS608B4PAL2	0.035
			M8 connector	XS608B4PAM8	0.015
			M12 connector	XS608B4PAM12	0.015
		NPN	Pre-cabled (L = 2 m)	XS608B4NAL2	0.035
			M8 connector	XS608B4NAM8	0.015
			M12 connector	XS608B4NAM12	0.015
	NC	PNP	Pre-cabled (L = 2 m)	XS608B4PBL2	0.035
			M8 connector	XS608B4PBM8	0.015
			M12 connector	XS608B4PBM12	0.015
		NPN	Pre-cabled (L = 2 m)	XS608B4NBL2	0.035
			M8 connector	XS608B4NBM8	0.015
			M12 connector	XS608B4NBM12	0.015

Ø 12, threaded M12 x 1

Sensing distance (Sn) mm	Function	Output	Connection	Reference	Weight kg
7	NO	PNP	Pre-cabled (L = 2 m) (1)	XS612B4PAL2	0.075
			M12 connector	XS612B4PAM12	0.020
			M12 connector	XS612B4NAM12	0.020
		NPN	Pre-cabled (L = 2 m) (1)	XS612B4NAL2	0.075
			M12 connector	XS612B4NAM12	0.020
			M12 connector	XS612B4NAM12	0.020
	NC	PNP	Pre-cabled (L = 2 m) (1)	XS612B4PBL2	0.075
			M12 connector	XS612B4PBM12	0.020
			M12 connector	XS612B4PBM12	0.020
		NPN	Pre-cabled (L = 2 m) (1)	XS612B4NBL2	0.075
			M12 connector	XS612B4NBM12	0.020
			M12 connector	XS612B4NBM12	0.020

Ø 18, threaded M18 x 1

Sensing distance (Sn) mm	Function	Output	Connection	Reference	Weight kg
12	NO	PNP	Pre-cabled (L = 2 m) (1)	XS618B4PAL2	0.100
			M12 connector	XS618B4PAM12	0.040
			M12 connector	XS618B4NAM12	0.040
		NPN	Pre-cabled (L = 2 m) (1)	XS618B4NAL2	0.100
			M12 connector	XS618B4NAM12	0.040
			M12 connector	XS618B4NAM12	0.040
	NC	PNP	Pre-cabled (L = 2 m) (1)	XS618B4PBL2	0.100
			M12 connector	XS618B4PBM12	0.040
			M12 connector	XS618B4PBM12	0.040
		NPN	Pre-cabled (L = 2 m) (1)	XS618B4NBL2	0.100
			M12 connector	XS618B4NBM12	0.040
			M12 connector	XS618B4NBM12	0.040

Ø 30, threaded M30 x 1.5

Sensing distance (Sn) mm	Function	Output	Connection	Reference	Weight kg
30	NO	PNP	Pre-cabled (L = 2 m) (1)	XS630B5PAL2	0.205
			M12 connector	XS630B5PAM12	0.145
			M12 connector	XS630B5NAM12	0.145
		NPN	Pre-cabled (L = 2 m) (1)	XS630B5NAL2	0.205
			M12 connector	XS630B5NAM12	0.145
			M12 connector	XS630B5NAM12	0.145
	NC	PNP	Pre-cabled (L = 2 m) (1)	XS630B5PBL2	0.205
			M12 connector	XS630B5PBM12	0.145
			M12 connector	XS630B5PBM12	0.145
		NPN	Pre-cabled (L = 2 m) (1)	XS630B5NBL2	0.205
			M12 connector	XS630B5NBM12	0.145
			M12 connector	XS630B5NBM12	0.145

Accessories (2)

Description	For use with sensors	Reference	Weight kg
Fixing clamps	Ø 8	XSZB108	0.004
	Ø 12	XSZB112	0.006
	Ø 18	XSZB118	0.010
	Ø 30	XSZB130	0.020
	Ø 30	XSZB130	0.020

(1) For a 5 m long cable replace L2 by L5; for a 10 m long cable replace L2 by L10. Please consult our Customer Care Centre for availability.
Example: XS612B4PAL2 becomes **XS612B4PAL5** with a 5 m cable.

(2) For more information, see page 118.

Inductive proximity sensors

XS range, general purpose

Cylindrical, increased range, non flush mountable

Three-wire DC, solid-state output

Characteristics		XS6...B...M8	XS6...B...M12	XS6...B...L2
Sensor type				
Product certifications		UL, CSA, CE, E2		
Connection	Connector	M8	M12	–
	Pre-cabled	–	–	Length: 2 m
Operating zone	Ø 8	mm	0...3.2	
	Ø 12	mm	0...5.6	
	Ø 18	mm	0...9.6	
	Ø 30	mm	0...24	
Differential travel		%	1...15 of effective sensing distance (Sr)	
Degree of protection	Conforming to IEC 60529		IP 65 and IP 67	IP 65 and IP 68, double insulation
	Conforming to DIN 40050		IP 69K	–
Storage temperature		°C	-40...+85	
Operating temperature		°C	-25...+70	
Materials	Case		Nickel plated brass, stainless steel grade 303 for XS608	
	Sensing face		PPS	
	Cable		–	PvR 3 x 0.34 mm ² except for Ø 8: 3 x 0.11 mm ²
Vibration resistance	Conforming to IEC 60068-2-6		25 gn, amplitude ± 2 mm (f = 10 to 55 Hz)	
Shock resistance	Conforming to IEC 60068-2-27		50 gn, duration 11 ms	
Output state indication			Yellow LED: 4 viewing ports at 90°	Yellow LED: annular
Rated supply voltage		V	12...48 with protection against reverse polarity	
Voltage limits (including ripple)		V	10...58	
Switching capacity		mA	≤ 200 with overload and short-circuit protection	
Voltage drop, closed state		V	≤ 2	
Current consumption, no-load		mA	≤ 10	
Maximum switching frequency	XS608B4... and XS612B4...	Hz	2500	
	XS618B4...	Hz	1000	
	XS630B5...	Hz	500	
Delays	First-up	ms	≤ 10 for Ø 8, Ø 12 and Ø 18; ≤ 15 for Ø 30	
	Response	ms	≤ 0.2 for Ø 8 and Ø 12; ≤ 0.3 for Ø 18; ≤ 0.6 for Ø 30	
	Recovery	ms	≤ 0.2 for Ø 8 and Ø 12; ≤ 0.7 for Ø 18; ≤ 1.4 for Ø 30	

Wiring schemes

Connector	Pre-cabled	PNP	NPN
M8	M12		
	BU: Blue BN: Brown BK: Black		

Setting-up

Minimum mounting distances (mm)

Mounting method	Ø 8	Ø 12	Ø 18	Ø 30
Side by side	e ≥ 24	e ≥ 48	e ≥ 72	e ≥ 300
Face to face	e ≥ 40	e ≥ 84	e ≥ 144	e ≥ 300
Facing a metal object	e ≥ 12	e ≥ 21	e ≥ 36	e ≥ 90
Mounted in a metal support	d ≥ 24, h ≥ 8	d ≥ 36, h ≥ 12	d ≥ 54, h ≥ 18	d ≥ 90, h ≥ 35

Dimensions

(1) LED	XS6	Pre-cabled (mm)			M8 Connector (mm)			M12 Connector (mm)		
		a	b	c	a	b	c	a	b	c
Ø 8		51	38	4	58	39	4	61	36	4
Ø 12		54	42	5	–	–	–	66	42	5
Ø 18		60	44	8	–	–	–	72	44	8
Ø 30		66	41	13	–	–	–	74	41	13

(1) LED

Inductive proximity sensors

XS range, general purpose

Cylindrical, increased range, non flush mountable

Three-wire DC, solid-state output

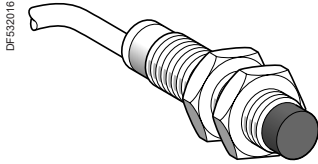

XS212B4●●L●

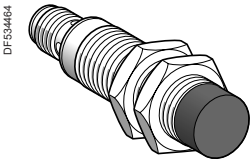

XS218B4●●M12

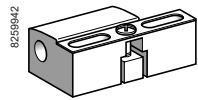

XSZB1●●

Sensors, 3-wire 12-24 V, short case model

Ø 12, threaded M12 x 1

Sensing distance (Sn) mm	Function	Output	Connection	Reference	Weight kg
8	NO	PNP	Pre-cabled (L = 2 m)	XS212B4PAL2	0.086
			Pre-cabled (L = 5 m)	XS212B4PAL5	0.160
			M12 connector	XS212B4PAM12	0.032
	NPN	PNP	Pre-cabled (L = 2 m)	XS212B4NAL2	0.086
			M12 connector	XS212B4NAM12	0.032
			NC	PNP	Pre-cabled (L = 2 m)
M12 connector	XS212B4PBM12	0.032			
NPN	PNP	Pre-cabled (L = 2 m)	XS212B4NBL2	0.086	

Ø 18, threaded M18 x 1

Sensing distance (Sn) mm	Function	Output	Connection	Reference	Weight kg
16	NO	PNP	Pre-cabled (L = 2 m)	XS218B4PAL2	0.105
			Pre-cabled (L = 5 m)	XS218B4PAL5	0.190
			M12 connector	XS218B4PAM12	0.052
	NPN	PNP	Pre-cabled (L = 2 m)	XS218B4NAL2	0.105
			M12 connector	XS218B4NAM12	0.052
			NC	PNP	Pre-cabled (L = 2 m)
M12 connector	XS218B4PBM12	0.052			

Accessories (1)

Description	For use with sensors	Reference	Weight kg
Fixing clamps	Ø 12	XSZB112	0.006
	Ø 18	XSZB118	0.010

(1) For further information, see page 118.

Characteristics		XS21●B4●●M12	XS21●B4●●L●
Sensor type		UL, CSA, CE, E2	
Product certifications		UL, CSA, CE, E2	
Connection	Connector	M12	—
	Pre-cabled	—	Length: 2 or 5 m
Operating zone	∅ 12	mm 0...6.4	
	∅ 18	mm 0...12.8	
Differential travel		% 1...15 of effective sensing distance (Sr)	
Degree of protection	Conforming to IEC 60529	IP 65 and IP 67	
	Conforming to DIN 40050	IP 69K	
Storage temperature		°C -40...+85	
Operating temperature		°C -25...+70	
Materials	Case	Brass	
	Sensing face	PPS	
	Cable	—	PvR 3 x 0.34 mm ²
Vibration resistance	Conforming to IEC 60068-2-6	25 gn, amplitude ± 2 mm (f = 10 to 55 Hz)	
Shock resistance	Conforming to IEC 60068-2-27	50 gn, duration 11 ms	
Output state indication		Yellow LED, 4 viewing ports at 90°	Yellow LED, annular
Rated supply voltage		V --- 12...24 with protection against reverse polarity	
Voltage limits (including ripple)		V --- 10...36	
Switching capacity		mA ≤ 200 with overload and short-circuit protection	
Voltage drop, closed state		V ≤ 2	
Current consumption, no-load		mA ≤ 10	
Maximum switching frequency	XS212B4●●●●	Hz 2000	
	XS218B4●●●●	Hz 1000	
Delays	First-up	ms ≤ 15	
	Response	ms ≤ 0.2 for ∅ 12 ≤ 0.3 for ∅ 18	
	Recovery	ms ≤ 0.2 for ∅ 12 ≤ 0.7 for ∅ 18	

Wiring schemes

Connector	Pre-cabled	PNP	NPN
M12 4 3 1 2	BU: Blue BN: Brown BK: Black		

Setting-up

Minimum mounting distances (mm)

Configuration	∅ 12	∅ 18
Side by side	e ≥ 100	e ≥ 120
Face to face	e ≥ 120	e ≥ 200
Facing a metal object	e ≥ 24	e ≥ 48
Mounted in a metal support	d ≥ 36, h ≥ 15	d ≥ 54, h ≥ 18

Dimensions

	Pre-cabled (mm)			M12 connector (mm)		
	a	b	c	a	b	c
∅ 12	37	20	5	51	26	5
∅ 18	41	21	8	51	21	8

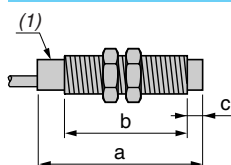

(1) LED

Inductive proximity sensors

XS range, general purpose

Cylindrical, increased range, non flush mountable

Two-wire AC or DC

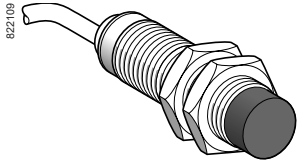

XS6...B4M...L2

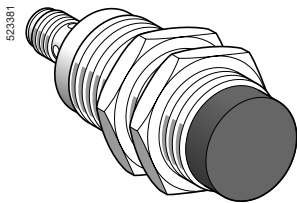

XS6...B4M...U20

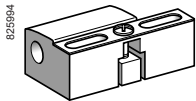

XSZB1...

Sensors, 2-wire \approx 24... 240 V, long case model

Ø 18, threaded M18 x 1

Sensing distance (Sn) mm	Function	Connection	Reference	Weight kg
12	NO	Pre-cabled (L = 2 m) (1)	XS618B4MAL2	0.120
		1/2"-20 UNF connector	XS618B4MAU20	0.060
	NC	Pre-cabled (L = 2 m) (1)	XS618B4MBL2	0.120
		1/2"-20 UNF connector	XS618B4MBU20	0.060

Ø 30, threaded M30 x 1.5

Sensing distance (Sn) mm	Function	Connection	Reference	Weight kg
22	NO	Pre-cabled (L = 2 m) (1)	XS630B4MAL2	0.205
		1/2"-20 UNF connector	XS630B4MAU20	0.145
	NC	Pre-cabled (L = 2 m) (1)	XS630B4MBL2	0.205
		1/2"-20 UNF connector	XS630B4MBU20	0.145

Accessories (2)

Description	For use with sensors	Reference	Weight kg
Fixing clamps	Ø 18	XSZB118	0.010
	Ø 30	XSZB130	0.020

(1) For a 5 m cable replace L2 by L5; for a 10 m cable replace L2 by L10.

Example: XS618B4MAL2 becomes **XS618B4MAL5** with a 5 m cable.

(2) For more information, see page 118.

Characteristics			XS6●●B4M●U20	XS6●●B4M●L2
Sensor type				
Product certifications			UL, CSA, CE	
Connection	Connector		1/2"-20 UNF	–
	1/2"-20 UNF Pre-cabled		–	Length: 2 m
Operating zone	Ø 18	mm	0...9.6	
	Ø 30	mm	0...17.6	
Differential travel		%	1...15 of effective sensing distance (Sr)	
Degree of protection	Conforming to IEC 60529		IP 65 and IP 67	IP 65 and IP 68, double insulation □
Storage temperature		°C	-40...+85	
Operating temperature		°C	-25...+70	
Materials	Case		Nickel plated brass	
	Sensing face		PPS	
	Cable		–	PvR 2 x 0.34 mm ²
Vibration resistance	Conforming to IEC 60068-2-6		25 gn, amplitude ± 2 mm (f = 10 to 55 Hz)	
Shock resistance	Conforming to IEC 60068-2-27		50 gn, duration 11 ms	
Output state indication			Yellow LED: 4 viewing ports at 90°	Yellow LED: annular
Rated supply voltage		V	~ or --- 24...240 (~ 50/60 Hz)	
Voltage limits (including ripple)		V	~ or --- 20...264	
Switching capacity		mA	~ 5...300 or --- 5...200 (1)	
Voltage drop, closed state		V	≤ 5.5	
Residual current, open state		mA	≤ 0.8	
Maximum switching frequency	XS618B4M●●●	Hz	~ 25 or --- 1000	
	XS630B4M●●●	Hz	~ 25 or --- 300	
Delays	First-up	ms	≤ 30 XS618B4M●●● and XS630B4M●●●	
	Response	ms	≤ 0.5	
	Recovery	ms	≤ 0.5 XS618B4M●●●, ≤ 2 XS630B4M●●●	

(1) It is essential to connect a 0.4 A "quick-blow" fuse in series with the load.

Wiring schemes

Connector	Pre-cabled	2-wire ~ or ---
1/2"-20 UNF	BU: Blue BN: Brown	NO or NC output
		⚡: on connector models only

Setting-up

Minimum mounting distances (mm)

	Side by side	Face to face	Facing a metal object	Mounted in a metal support
Ø 18	e ≥ 72	e ≥ 144	e ≥ 36	d ≥ 54, h ≥ 18
Ø 30	e ≥ 120	e ≥ 264	e ≥ 66	d ≥ 90, h ≥ 30

Dimensions

	Pre-cabled (mm)			Connector (mm)		
	a	b	c	a	b	c
Ø 18	60	44	8	72	44	8
Ø 30	63	41	13	74	41	13

(1) LED

Inductive proximity sensors

XS range, general purpose, standard range
 Flat format, flush mountable
 Two-wire DC
 Three-wire DC, solid-state output

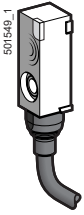

XS7J1A1●●L2

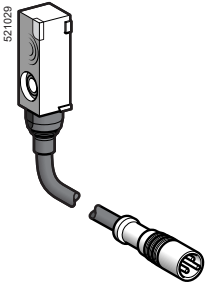

XS7J1A1●●L01M8

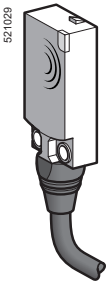

XS7F1A1●●L2

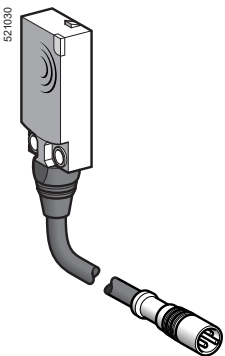

XS7F1A1●●L01M8

Flat, 8 x 22 x 8 mm format (1) (2)

Three-wire ---

Sensing distance (Sn) mm	Function	Output	Connection	Reference	Weight kg
2.5	NO	PNP	Pre-cabled (L = 2 m) (3)	XS7J1A1PAL2	0.060
			Remote M8 connector on 0.15 m flying lead	XS7J1A1PAL01M8	0.040
	NPN	PNP	Pre-cabled (L = 2 m) (3)	XS7J1A1NAL2	0.060
			Remote M8 connector on 0.15 m flying lead	XS7J1A1NAL01M8	0.040
	NC	PNP	Pre-cabled (L = 2 m) (3)	XS7J1A1PBL2	0.060
			Remote M8 connector on 0.15 m flying lead	XS7J1A1PBL01M8	0.040
NPN	PNP	Pre-cabled (L = 2 m) (3)	XS7J1A1NBL2	0.060	
		Remote M8 connector on 0.15 m flying lead	XS7J1A1NBL01M8	0.040	

Two-wire ---

Sensing distance (Sn) mm	Function	Output	Connection	Reference	Weight kg
2.5	NO		Pre-cabled (L = 2 m) (3)	XS7J1A1DAL2	0.050
			Remote M8 connector on 0.15 m flying lead	XS7J1A1DAL01M8	0.035
NC			Pre-cabled (L = 2 m) (3)	XS7J1A1DBL2	0.050
			Remote M8 connector on 0.15 m flying lead	XS7J1A1DBL01M8	0.035

Flat, 15 x 32 x 8 mm format (1)

Three-wire ---

Sensing distance (Sn) mm	Function	Output	Connection	Reference	Weight kg
5	NO	PNP	Pre-cabled (L = 2 m) (3)	XS7F1A1PAL2	0.065
			Remote M8 connector on 0.15 m flying lead	XS7F1A1PAL01M8	0.045
	NPN	PNP	Pre-cabled (L = 2 m) (3)	XS7F1A1NAL2	0.065
			Remote M8 connector on 0.15 m flying lead	XS7F1A1NAL01M8	0.045
	NC	PNP	Pre-cabled (L = 2 m) (3)	XS7F1A1PBL2	0.065
			Remote M8 connector on 0.15 m flying lead	XS7F1A1PBL01M8	0.045
NPN	PNP	Pre-cabled (L = 2 m) (3)	XS7F1A1NBL2	0.065	
		Remote M8 connector on 0.15 m flying lead	XS7F1A1NBL01M8	0.045	

Two-wire ---

Sensing distance (Sn) mm	Function	Output	Connection	Reference	Weight kg
5	NO		Pre-cabled (L = 2 m) (3)	XS7F1A1DAL2	0.055
			Remote M8 connector on 0.15 m flying lead	XS7F1A1DAL01M8	0.045
NC			Pre-cabled (L = 2 m) (3)	XS7F1A1DBL2	0.055
			Remote M8 connector on 0.15 m flying lead	XS7F1A1DBL01M8	0.045

(1) For accessories, see page 118.

(2) Sensors **XS7J** include a fixing clamp with screw.

(3) For a 5 m long cable replace L2 by **L5**; for a 10 m long cable replace L2 by **L10**.
 Example: **XS7J1A1PAL2** becomes **XS7J1A1PAL5** with a 5 m long cable.

Inductive proximity sensors

XS range, general purpose, standard range

Flat format, flush mountable

Two-wire DC

Three-wire DC, solid-state output

Characteristics		XS7J●●●●●L01M8	XS7F●●●●●L01M8	XS7J●●●●●L2, XS7F●●●●●L2
Sensor type		CE	UL, CSA, CE	
Product certifications				
Connection	Connector	Remote M8 connector on 0.15 m flying lead		–
	Pre-cabled	–		Length: 2 m
Operating zone	XS7J	mm	0...2	
	XS7F	mm	0...4	
Differential travel		%	1...15 of effective sensing distance (Sr)	
Degree of protection	Conforming to IEC 60529		IP 67 (XS7J), IP 68 (XS7F)	
Storage temperature		°C	-40...+85	
Operating temperature		°C	-25...+70	
Materials	Case		PBT	
	Cable		PvR 3 x 0.11 mm ² or 2 x 0.11 mm ² (XS7F: 2 or 3 x 0.34 mm ²)	
Vibration resistance	Conforming to IEC 60068-2-6		25 gn, amplitude ± 2 mm (f = 10 to 55 Hz)	
Shock resistance	Conforming to IEC 60068-2-27		50 gn, duration 11 ms	
Output state indication			Yellow LED	
Rated supply voltage		V	12...24 with protection against reverse polarity	
Voltage limits (including ripple)		V	10...36	
Current consumption, no-load	3-wire	mA	≤ 10	
Residual current, open state	2-wire	mA	≤ 0.5	
Switching capacity	3-wire	mA	100 with overload and short-circuit protection	
	2-wire	mA	1.5...100 with overload and short-circuit protection	
Voltage drop, closed state	3-wire	V	≤ 2	
	2-wire	V	≤ 4	
Maximum switching frequency	3-wire	kHz	2	
	2-wire	kHz	4 for XS7J, 5 for XS7F	
Delays	First-up	ms	Three-wire: 5	
		ms	Two-wire: 10 XS7J, 5 XS7F	
	Response	ms	Three-wire: 0,1	
		ms	Two-wire: 0,5 XS7J, 5 XS7F	
		Recovery	ms	Three-wire: 0,1
ms	Two-wire: 1 XS7J, 5 XS7F			

Connector	Pre-cabled	PNP NO or NC	NPN NO or NC	2-wire NO	2-wire NC
M8 	BU: Blue BN: Brown BK: Black				

Setting-up	Minimum mounting distances (mm)												
	<table border="1"> <thead> <tr> <th></th> <th>Side by side</th> <th>Face to face</th> <th>Facing a metal object</th> </tr> </thead> <tbody> <tr> <td>XS7J</td> <td>e ≥ 7.5</td> <td>e ≥ 20</td> <td>e ≥ 7.5</td> </tr> <tr> <td>XS7F</td> <td>e ≥ 15</td> <td>e ≥ 40</td> <td>e ≥ 15</td> </tr> </tbody> </table>		Side by side	Face to face	Facing a metal object	XS7J	e ≥ 7.5	e ≥ 20	e ≥ 7.5	XS7F	e ≥ 15	e ≥ 40	e ≥ 15
	Side by side	Face to face	Facing a metal object										
XS7J	e ≥ 7.5	e ≥ 20	e ≥ 7.5										
XS7F	e ≥ 15	e ≥ 40	e ≥ 15										

Dimensions	XS7F	XS7J
		(1) LED (2) For CHC type screws

Inductive proximity sensors

XS range, general purpose, standard range
Flat format, flush mountable
Two-wire DC
Three-wire DC, solid-state output

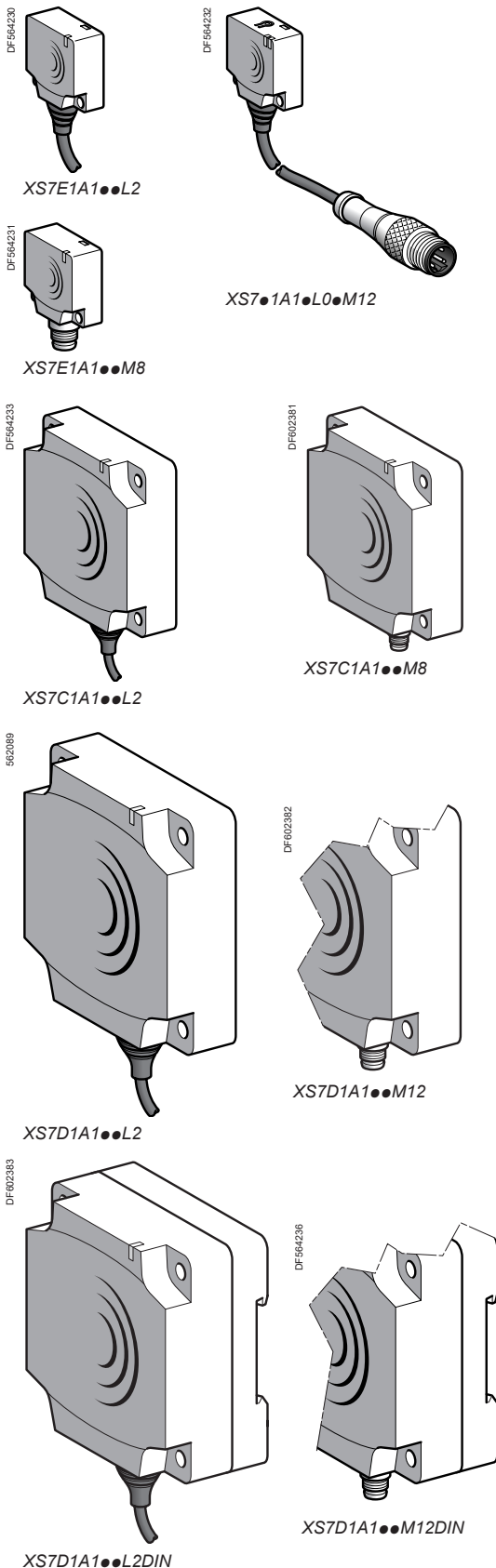

Sens. dist. (Sn) mm	Function	Output	Connection	Reference	Weight kg	
Flat, 26 x 26 x 13 mm format (1)						
Three-wire ---						
10	NO	PNP	Pre-cabled (L = 2 m) (4)	XS7E1A1PAL2	0.075	
			M8 connector	XS7E1A1PAM8	0.040	
			Remote M12 connector	XS7E1A1PAL01M12	0.040	
		NPN	Pre-cabled (L = 2 m) (4)	XS7E1A1NAL2	0.075	
			M8 connector	XS7E1A1NAM8	0.075	
			Remote M12 connector	XS7E1A1NAL01M12	0.040	
	NC	PNP	Pre-cabled (L = 2 m) (4)	XS7E1A1PBL2	0.075	
			M8 connector	XS7E1A1PBM8	0.040	
			Remote M12 connector	XS7E1A1PBL01M12	0.040	
		NPN	Pre-cabled (L = 2 m) (4)	XS7E1A1NBL2	0.075	
			M8 connector	XS7E1A1NBM8	0.040	
			Remote M12 connector	XS7E1A1NBL01M12	0.040	
Two-wire ---						
10	NO	PNP	Pre-cabled (L = 2 m) (4)	XS7E1A1DAL2	0.070	
			M8 connector	XS7E1A1DAM8	0.040	
			Remote M12 connector	XS7E1A1DAL01M12	0.040	
		NO terminals 1 and 4 (2)	Remote M12 connector	XS7E1A1CAL01M12	0.040	
			Remote M12 connector (3)	XS7E1A1CAL08M12	0.065	
			NC	PNP	Pre-cabled (L = 2 m) (4)	XS7E1A1DBL2
	M8 connector	XS7E1A1DBM8			0.040	
	Remote M12 connector	XS7E1A1DBL01M12			0.040	
	NPN	Pre-cabled (L = 2 m) (4)		XS7E1A1NDBL2	0.070	
		M8 connector		XS7E1A1NDBM8	0.040	
		Remote M12 connector		XS7E1A1NDBL01M12	0.040	
	Flat, 40 x 40 x 15 mm format (1)					
Three-wire ---						
15	NO	PNP	Pre-cabled (L = 2 m) (4)	XS7C1A1PAL2	0.095	
			M8 connector	XS7C1A1PAM8	0.060	
			Remote M12 connector	XS7C1A1PAL01M12	0.060	
		NPN	Pre-cabled (L = 2 m) (4)	XS7C1A1NAL2	0.095	
			M8 connector	XS7C1A1NAM8	0.060	
			Remote M12 connector	XS7C1A1NAL01M12	0.060	
	NC	PNP	Pre-cabled (L = 2 m) (4)	XS7C1A1PBL2	0.095	
			M8 connector	XS7C1A1PBM8	0.060	
			Remote M12 connector	XS7C1A1PBL01M12	0.060	
		NPN	Pre-cabled (L = 2 m) (4)	XS7C1A1NBL2	0.095	
			M8 connector	XS7C1A1NBM8	0.060	
			Remote M12 connector	XS7C1A1NBL01M12	0.060	
	Two-wire ---					
	15	NO	PNP	Pre-cabled (L = 2 m) (4)	XS7C1A1DAL2	0.090
				M8 connector	XS7C1A1DAM8	0.060
				Remote M12 connector	XS7C1A1DAL01M12	0.060
			NO terminals 1 and 4 (2)	Remote M12 connector	XS7C1A1CAL01M12	0.060
				Remote M12 connector (3)	XS7C1A1CAL08M12	0.090
NC				PNP	Pre-cabled (L = 2 m) (4)	XS7C1A1DBL2
		M8 connector	XS7C1A1DBM8		0.060	
		Remote M12 connector	XS7C1A1DBL01M12		0.060	
		NPN	Pre-cabled (L = 2 m) (4)	XS7C1A1NDBL2	0.090	
			M8 connector	XS7C1A1NDBM8	0.060	
			Remote M12 connector	XS7C1A1NDBL01M12	0.060	
Flat, 80 x 80 x 26 mm format (1)						
Three-wire ---						
40	NO	PNP	Pre-cabled (L = 2 m) (4)	XS7D1A1PAL2 (5)	0.340	
			M12 connector	XS7D1A1PAM12 (5)	0.290	
			M12 connector	XS7D1A1PAL01M12 (5)	0.290	
		NPN	Pre-cabled (L = 2 m) (4)	XS7D1A1NAL2 (5)	0.340	
			M12 connector	XS7D1A1NAM12 (5)	0.290	
			M12 connector	XS7D1A1NAL01M12 (5)	0.290	
	NC	PNP	Pre-cabled (L = 2 m) (4)	XS7D1A1PBL2 (5)	0.340	
			M12 connector	XS7D1A1PBM12 (5)	0.290	
			M12 connector	XS7D1A1PBL01M12 (5)	0.290	
		NPN	Pre-cabled (L = 2 m) (4)	XS7D1A1NBL2 (5)	0.340	
			M12 connector	XS7D1A1NBM12 (5)	0.290	
			M12 connector	XS7D1A1NBL01M12 (5)	0.290	
Two-wire ---						
40	NO	PNP	Pre-cabled (L = 2 m) (4)	XS7D1A1DAL2 (5)	0.340	
			M12 connector	XS7D1A1DAM12 (5)	0.290	
			M12 connector	XS7D1A1DAL01M12 (5)	0.290	
	NO terminals 1 and 4 (2)	Remote M12 connector	XS7D1A1CAM12 (5)	0.290		
		Remote M12 connector (3)	XS7D1A1CAL08M12 (5)	0.340		
		NC	PNP	Pre-cabled (L = 2 m) (4)	XS7D1A1DBL2 (5)	0.340
M12 connector	XS7D1A1DBM12 (5)			0.290		
M12 connector	XS7D1A1DBL01M12 (5)			0.290		

(1) For accessories, see page 118.
 (2) The NO output is connected to terminals 1 and 4 of the M12 connector.
 (3) Remote connector on 0.8 m flying lead.

(4) For a 5 m long cable replace L2 by L5; for a 10 m long cable replace L2 by L10.
 Example: S7 J1A1PAL2 becomes XS7J1A1PAL5 with a 5 m long cable.
 (5) For clipping onto 35 mm omega rail or 80 x 80 x 40 mm format, add DIN to the end of the reference. Example: XS7D1A1PAL2 becomes XS7D1A1PAL2DIN.

Characteristics		XS7E●●●●●M8, XS7C●●●●●M8, XS7D●●●●●M12	XS7E●●●●●L01M12, XS7C●●●●●L01M12	XS7E●●●●●L2, XS7C●●●●●L2, XS7D●●●●●L2
Sensor type				
Product certifications		UL, CSA, CE, ECOLAB		
Connection	Connector	M8 except M12 on XS7D●●●●●M12	M12 on 0.15 m flying lead for XS7●●●●●L01M12	–
	Pre-cabled	–	–	Length: 2 m
Operating zone	XS7E	mm	0...8	
	XS7C	mm	0...12	
	XS7D	mm	0...32	
Differential travel		%		
Degree of protection		Conforming to IEC 60529		IP 67, double insulation □ (except for M8 connector: IP 67) IP 68, □
Storage temperature		°C		
Operating temperature		°C		
Materials	Case	PBT		
	Cable	–	PvR 3 x 0.34 mm ² or 2 x 0.34 mm ²	
Vibration resistance		Conforming to IEC 60068-2-6		
Shock resistance		Conforming to IEC 60068-2-27		
Output state indication		Yellow LED		
Rated supply voltage		V		
Voltage limits (including ripple)		V		
Current consumption, no-load		3-wire	mA	
Residual current, open state		2-wire	mA	
Switching capacity		3-wire	mA	
		2-wire	mA	
Voltage drop, closed state		3-wire	V	
		2-wire	V	
Maximum switching frequency		XS7E, XS7C	kHz	
		XS7D	Hz	
Delays	First-up	3-wire	ms	
		2-wire	ms	
	Response	3-wire	ms	
		2-wire	ms	
	Recovery	3-wire	ms	
		2-wire	ms	

Wiring schemes

Connector

M12 M8

4 3 1 2 4 3

Pre-cabled

BU: Blue
BN: Brown
BK: Black

PNP (1)

BN/1 +
PNP BK/4 (NO)
BK/2 (NC)
BU/3 -

2-wire NO/M12 or M8

BN/3 +/-
BU/4 -/+

2-wire NC/M12 or M8

BN/1 +/-
BU/2 (M12) -/+
BU/3 (M8)

NPN (1)

BN/1 +
NPN BK/4 (NO)
BK/2 (NC)
BU/3 -

2-wire NO/M12 XS7●●●●●CA●●●

BN/1 +/-
BU/4 -/+

(1) For M8 connector, NO and NC outputs on terminal 4

Setting-up

Minimum mounting distances (mm)

Side by side	e ≥	XS7E	XS7C	XS7D
		30	45	120
Face to face	e ≥	XS7E	XS7C	XS7D
		72	110	300
Facing a metal object	e ≥	XS7E	XS7C	XS7D
		30	45	120

Dimensions

	XS7C/D/E	XS7C/D	XS7E
	A (cable)	A (connector)	B
	14	11	26
	C	13	13
	D	8.8	8.8
	E	20	20
	F	3.5	3.5
	XS7C	14	11
	XS7D	23	18
	XS7D●●DIN	23	18
	B	40	80
	C	15	26
	D	9.8	16
	E	33	65
	F	4.5	5.5
		30	65
			5.1

(1) LED
(2) For CHC type screws

Inductive proximity sensors

XS range, general purpose
Cubic case, 40 x 40 x 70 mm, M12 or 1/2"-20UNF
connector
5 position turret head

Sensor	Flush mountable in metal	Non flush mountable in metal
--------	--------------------------	------------------------------

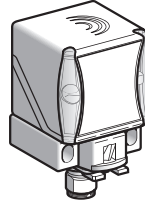

Nominal sensing distance (Sn)	15 mm	20 mm	40 mm
-------------------------------	-------	-------	-------

References

4-wire ---	PNP NO+NC	—	XS8C2A1PCM12	XS8C2A4PCM12
	NPN NO+NC	—	XS8C2A1NCM12	XS8C2A4NCM12
3-wire ---	PNP NO	XS7C2A1PAM12	—	—
	NPN NO	XS7C2A1NAM12	—	—
	PNP NC	XS7C2A1PBM12	—	—
	NPN NC	XS7C2A1NBM12	—	—
2-wire ---	NO	XS7C2A1DAM12	XS8C2A1DAM12	XS8C2A4DAM12
	NC	XS7C2A1DBM12	XS8C2A1DBM12	XS8C2A4DBM12
2-wire (~/-) unprotected (1)	NO	XS7C2A1MAU20	XS8C2A1MAU20	XS8C2A4MAU20
	NC	XS7C2A1MBU20	XS8C2A1MBU20	XS8C2A4MBU20
Weight (kg)	0.149	0.149	0.149	

Characteristics

Operating zone		0...12 mm	0...16 mm	0...32 mm
Product certifications		UL, CSA, CE, TÜV (4-wire), E2 (3-wire and 4-wire)		
Conformity to standards		IEC 60947-5-2		
Conformity to safety standards (2)	For XS8C2A●PCM12	EN 62061 (2005): SILcl2 EN 61508 (2010): SIL 2, EN ISO 13849 (2008): PL d		
Reliability data (2)	For XS8C2A●PCM12	MTTFd = 1546 years PFHd = 7.4 10 ⁻⁸ 1/h		
Connection		M12 connector for --- versions 1/2"-20UNF connector for ~/- versions		
Differential travel		3...15% of Sr		
Degree of protection	Conforming to IEC 60529 and DIN 40050	IP 65, IP 67 and IP 69K		
Temperature	Storage Operation (3)	-40...+85°C -25...+70°C		
Material		Case: PBT		
Vibration resistance	Conforming to IEC 60068-2-6	25 gn, amplitude ± 2 mm (f = 10...55 Hz)		
Shock resistance	Conforming to IEC 60068-2-27	50 gn for 11 ms		
Indicators	Output state Power on	Yellow LED Green LED, for 4-wire ---, 3-wire --- and 2-wire ~/- versions		
Rated supply voltage	4-wire ---	12...48 V with protection against reverse polarity		
	3-wire ---	12...24 V with protection against reverse polarity		
	2-wire ---	12...48 V with protection against reverse polarity		
	2-wire ~/-	24...240 V (~ 50/60 Hz)		
Voltage limits (including ripple)	4-wire ---	10...58 V		
	3-wire ---	10...36 V		
	2-wire ---	10...58 V		
	2-wire ~/-	20...264 V		
Current consumption, no-load	3-wire and 4-wire ---	< 15 mA		
Residual current, open state	2-wire ---	< 0.6 mA		
	2-wire ~/-	1.5 mA		
Switching capacity	3-wire and 4-wire ---	< 200 mA with overload and short-circuit protection		
	2-wire ---	< 100 mA with overload and short-circuit protection		
	2-wire ~/-	~: 5...300 mA (1) ---: 5...200 mA (1)		
Voltage drop, closed state	3-wire and 4-wire ---	< 2 V		
	2-wire ---	< 4.2 V		
	2-wire ---/~	< 5.5 V		
Maximum switching frequency		Flush mountable: --- 300 Hz, ~ 25 Hz Non flush mountable: --- 150 Hz, ~ 25 Hz		
Delays	First-up	7 ms (3-wire and 4-wire ---), 20 ms (2-wire --- and 2-wire ---/~)		
	Response	Flush mountable: ≤ 1.2 ms. Non flush mountable: ≤ 1.4 ms		
	Recovery	Flush mountable: ≤ 1.8 ms. Non flush mountable: ≤ 3.5 ms		

(1) Sensor must be protected by a 0.4 A quick-blow fuse (reference **XUZE04**) connected in series with the load.

(2) SIL 2 protection can only be obtained by connecting both outputs to a safety PLC.

(3) Sensors are available for very low temperatures (suffix **TF**: -40°C, +70°C) or very high temperatures (suffix **TT**: -25°C, +85°C). Please consult our Customer Care Centre.

Inductive proximity sensors

XS range, general purpose
Cubic case, 40 x 40 x 70 mm, M12 or 1/2"-20UNF
connector
5 position turret head

Setting-up precautions

Minimum mounting distances (mm)

		Side by side	Face to face	Facing a metal object
Sensors flush mountable in metal	XS7C2A1●●	$e \geq 60$	$e \geq 120$	$e \geq 45$
	XS8C2A1●●	$e \geq 80$	$e \geq 160$	$e \geq 60$
Sensors non flush mountable in metal	XS8C2A4●●	$e \geq 160$	$e \geq 320$	$e \geq 120$

Wiring schemes

4-wire $\overline{\text{N}}$, NO + NC outputs

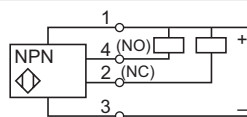
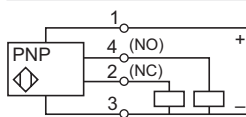

3-wire, PNP

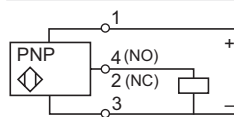

3-wire, NPN

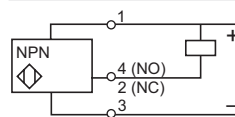

2-wire, 1/2"-20UNF

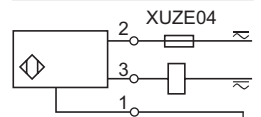

2-wire $\overline{\text{N}}$, NO output (M12 connector)

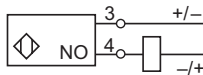

2-wire $\overline{\text{N}}$, NC output (M12 connector)

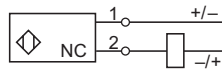

M12 connector

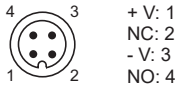

1/2"-20UNF connector



Accessory references

Description	Type	Length m	Reference	Weight kg
Pre-wired M12 connectors Female, 4-pin, zinc die-cast, nickel plated clamping ring	Straight	2	XZCP1141L2	0.090
		5	XZCP1141L5	0.190
		10	XZCP1141L10	0.370
	Elbowed	2	XZCP1241L2	0.090
		5	XZCP1241L5	0.190
		10	XZCP1241L10	0.370
Pre-wired 1/2"-20UNF connectors Female, 3-pin, zinc die-cast, nickel plated clamping ring	Straight	5	XZCP1865L5	0.180
		10	XZCP1865L10	0.350
		10	XZCP1865L10	0.350
	Elbowed	5	XZCP1965L5	0.180
		10	XZCP1965L10	0.350
		10	XZCP1965L10	0.350

Dimensions

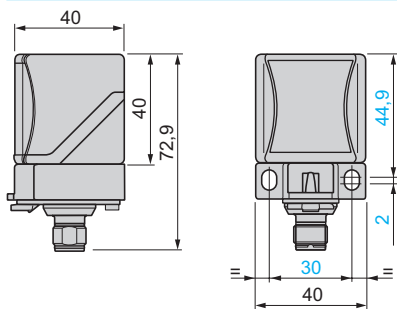

Head positions

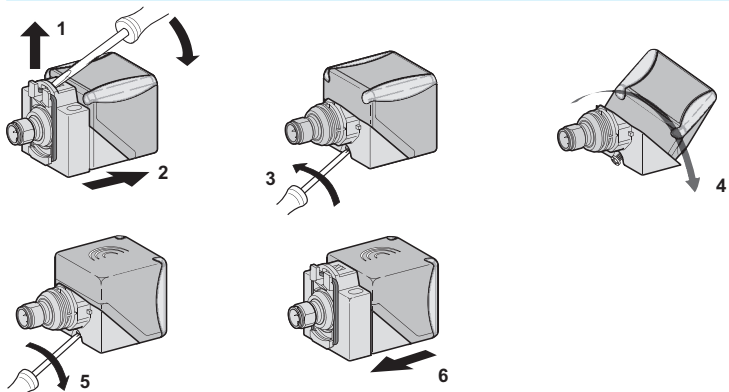

Example SIL 2 wiring scheme (with XPSMCMCP0802 safety PLC)

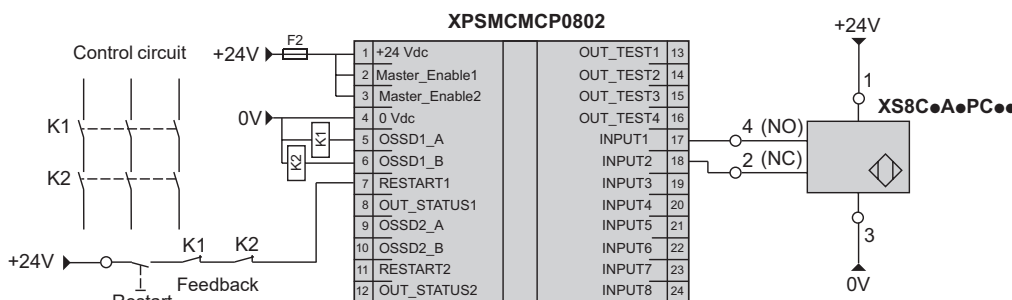

SFF (Safe Failure Fraction): 92,68 %
DC (Diagnosis Coverage): 75,8 %

Inductive proximity sensors

XS range, general purpose

Plastic case, 40 x 40 x 117 mm, plug-in

5 position turret head

Sensor	Flush mountable in metal	Non flush mountable in metal
--------	--------------------------	------------------------------

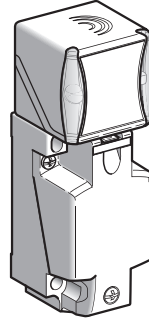

Nominal sensing distance (Sn)	15 mm	20 mm	40 mm
-------------------------------	-------	-------	-------

References

4-wire $\overline{---}$	PNP NO+NC	–	XS8C4A1PCP20	XS8C4A4PCP20
	NPN NO+NC	–	XS8C4A1NCP20	XS8C4A4NCP20
2-wire $\overline{---}$	NO or NC programmable	XS7C4A1DPP20	XS8C4A1DPP20	XS8C4A4DPP20
2-wire ($\sim/\overline{---}$) unprotected (1)	NO or NC programmable	XS7C4A1MPP20	XS8C4A1MPP20	XS8C4A4MPP20
Weight (kg)		0.244	0.244	0.244

*Note: These sensors have an M20 cable entry. They can also be supplied with a PG 13.5 cable entry (e.g. **XS8C4A4PCG13**) or a 1/2" NPT cable entry (e.g. **XS8C4A1MPN12**). Please consult our Customer Care Centre.*

Characteristics

Operating zone		0...12 mm	0...16 mm	0...32 mm
Product certifications		UL, CSA, CE, TÜV (4-wire), E2 (4-wire)		
Conformity to standards		IEC 60947-5-2		
Conformity to safety standards (2)	For XS8C4A●PCP20	EN 62061 (2005): SILcl2, EN 61508 (2010): SIL 2, EN ISO 13849 (2008): PL d		
Reliability data (2)	For XS8C4A●PCP20	MTTFd = 1546 years PFHd = 7.4 10 ⁻⁸ 1/h		
Connection		Screw terminals, clamping capacity: 2 or 4 x 1.5 mm ² / 2 or 4 x 16 AWG (3)		
Differential travel		3...15% of Sr		
Degree of protection	Conforming to IEC 60529 and DIN 40050	IP 65, IP 67 and IP 69K		
Temperature	Storage	- 40...+ 85°C		
	Operation (4)	- 25...+ 70°C		
Material		Case: PBT		
Vibration resistance	Conforming to IEC 60068-2-6	25 gn, amplitude ± 2 mm (f = 10...55 Hz)		
Shock resistance	Conforming to IEC 60068-2-27	50 gn for 11 ms		
Indicators	Output state	Yellow LED		
	Power on	Green LED, for 4-wire $\overline{---}$ and 2-wire $\sim/\overline{---}$ versions		
Rated supply voltage	4-wire $\overline{---}$	12...48 V with protection against reverse polarity		
	2-wire $\overline{---}$	12...48 V with protection against reverse polarity		
	2-wire $\sim/\overline{---}$	24...240 V (\sim 50/60 Hz)		
Voltage limits (including ripple)	4-wire $\overline{---}$	10...58 V		
	2-wire $\overline{---}$	10...58 V		
	2-wire $\sim/\overline{---}$	20...264 V		
Current consumption, no-load	4-wire $\overline{---}$	< 15 mA		
Residual current, open state	2-wire $\overline{---}$	< 0.6 mA		
	2-wire $\sim/\overline{---}$	1.5 mA		
Switching capacity	4-wire $\overline{---}$	< 200 mA with overload and short-circuit protection		
	2-wire $\overline{---}$	< 100 mA with overload and short-circuit protection		
	2-wire $\sim/\overline{---}$	\sim : 5...300 mA (1) $\overline{---}$: 5...200 mA (1)		
Voltage drop, closed state	4-wire $\overline{---}$	< 2 V		
	2-wire $\overline{---}$	< 4.2 V		
	2-wire $\overline{---}/\sim$	< 5.5 V		
Maximum switching frequency		Flush mountable: $\overline{---}$ 300 Hz, \sim 25 Hz Non flush mountable: $\overline{---}$ 150 Hz, \sim 25 Hz		
Delays	First-up	7 ms (3-wire and 4-wire $\overline{---}$), 20 ms (2-wire $\overline{---}$ and 2-wire $\overline{---}/\sim$)		
	Response	Flush mountable: ≤ 1.2 ms. Non flush mountable: ≤ 1.4 ms		
	Recovery	Flush mountable: ≤ 1.8 ms. Non flush mountable: ≤ 3.5 ms		

(1) Sensor must be protected by a 0.4 A quick-blow fuse (reference **XUZE04**) connected in series with the load.

(2) SIL 2 protection can only be obtained by connecting both outputs to a safety PLC.

(3) These sensors are supplied without a cable gland. An adaptable PG 13.5 cable gland is available (reference **XSZPE13**). Accessories are available for connection to an M12 or 7/8"-16UN connector which can be added to the PG 13.5 sensor. Please consult our Customer Care Centre.

(4) Sensors are available for very low temperatures (suffix **TF**: - 40°C, + 70°C) or very high temperatures (suffix **TT**: - 25°C, + 85°C). Please consult our Customer Care Centre.

Inductive proximity sensors

XS range, general purpose

Plastic case, 40 x 40 x 117 mm, plug-in

5 position turret head

Setting-up precautions

Minimum mounting distances (mm)

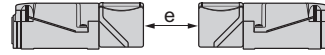
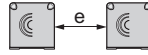

		Side by side	Face to face	Facing a metal object
Sensors flush mountable in metal	XS7C4A1●●	$e \geq 60$	$e \geq 120$	$e \geq 45$
	XS8C4A1●●	$e \geq 80$	$e \geq 160$	$e \geq 60$
Sensors non flush mountable in metal	XS8C4A4●●	$e \geq 160$	$e \geq 320$	$e \geq 120$

Wiring schemes

NO + NC outputs

4-wire ...

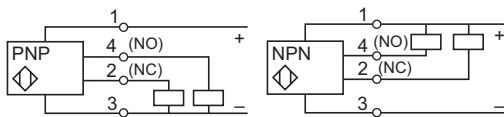

NO or NC outputs, depending on position of link

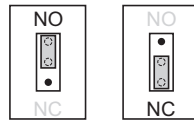

2-wire ... (non polarised)

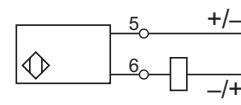

2-wire ~ or ... (programmable)

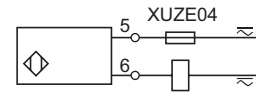

Dimensions

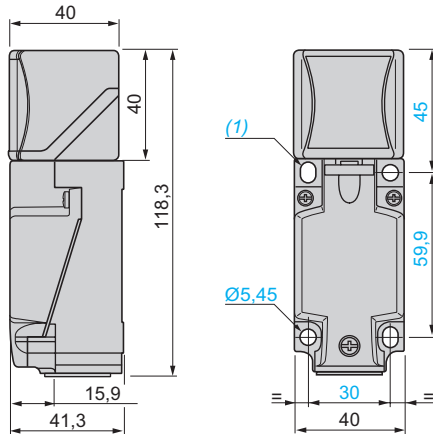

Head positions

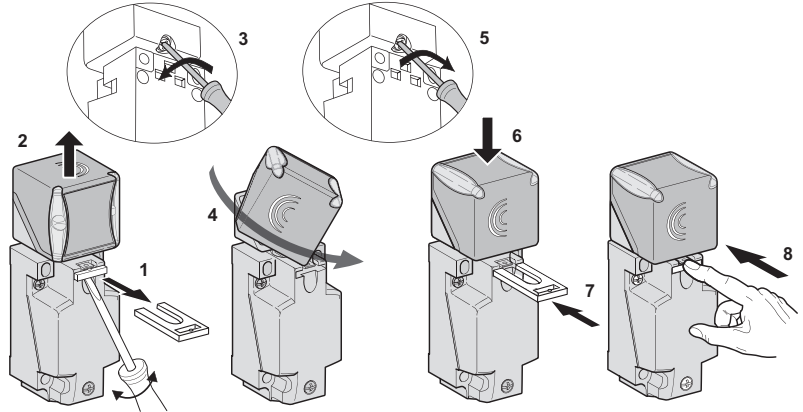

(1) 2 elongated holes Ø 5.3 x 7 cm.

Tightening torque of cover fixing screws and clamp screws: < 1.2 N.m / < 10.62 lb-in

Example SIL 2 wiring scheme (with XPSMCMCP0802 safety PLC)

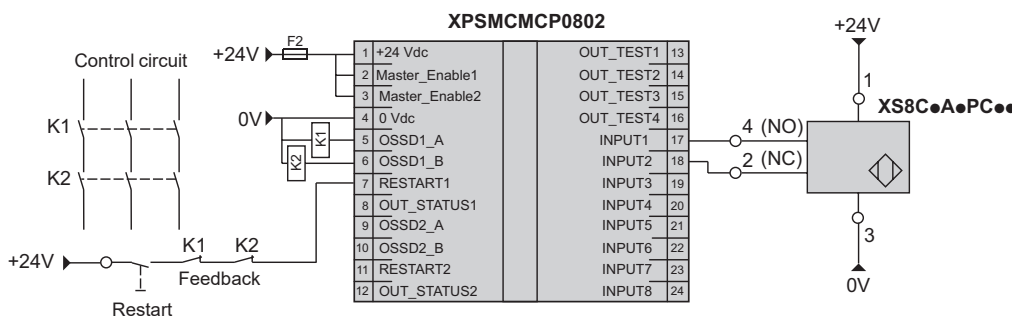

SFF (Safe Failure Fraction): 92,68 %
DC (Diagnosis Coverage): 75,8 %

Inductive proximity sensors

XS range, general purpose

Multivoltage sensor, cylindrical, flush mountable and non flush mountable

Two-wire AC or DC, short-circuit protection

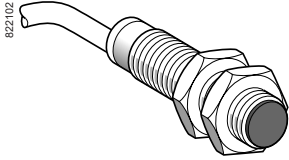

XS1M●●●●250

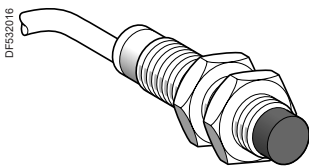

XS2M●●●●250

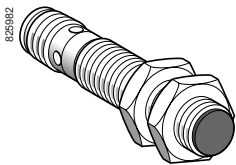

XS1M●●●●250K

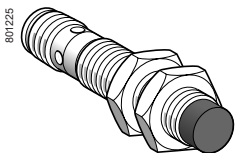

XS2M●●●●250K

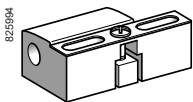

XSZB1●●

Sensing distance (Sn) mm	Function	Connection	Reference	Weight kg
--------------------------	----------	------------	-----------	-----------

Ø 12, threaded M12 x 1

Flush mountable				
2	NO	Pre-cabled (L = 2 m) (1)	XS1M12MA250	0.075
		1/2"-20UNF connector	XS1M12MA250K	0.025
	NC	Pre-cabled (L = 2 m) (1)	XS1M12MB250	0.075
		1/2"-20UNF connector	XS1M12MB250K	0.025

Non flush mountable

4	NO	Pre-cabled (L = 2 m) (1)	XS2M12MA250	0.075
		1/2"-20UNF connector	XS2M12MA250K	0.025
	NC	Pre-cabled (L = 2 m) (1)	XS2M12MB250	0.075

Ø 18, threaded M18 x 1

Flush mountable				
5	NO	Pre-cabled (L = 2 m) (1)	XS1M18MA250	0.120
		1/2"-20UNF connector	XS1M18MA250K	0.060
	NC	Pre-cabled (L = 2 m) (1)	XS1M18MB250	0.120
		1/2"-20UNF connector	XS1M18MB250K	0.060

Non flush mountable

8	NO	Pre-cabled (L = 2 m) (1)	XS2M18MA250	0.120
		1/2"-20UNF connector	XS2M18MA250K	0.060
	NC	Pre-cabled (L = 2 m) (1)	XS2M18MB250	0.120
		1/2"-20UNF connector	XS2M18MB250K	0.060

Ø 30, threaded M30 x 1.5

Flush mountable				
10	NO	Pre-cabled (L = 2 m) (1)	XS1M30MA250	0.205
		1/2"-20UNF connector	XS1M30MA250K	0.145
	NC	Pre-cabled (L = 2 m) (1)	XS1M30MB250	0.205
		1/2"-20UNF connector	XS1M30MB250K	0.145

Non flush mountable

15	NO	Pre-cabled (L = 2 m) (1)	XS2M30MA250	0.205
		1/2"-20UNF connector	XS2M30MA250K	0.145
	NC	Pre-cabled (L = 2 m) (1)	XS2M30MB250	0.205
		1/2"-20UNF connector	XS2M30MB250K	0.145

Accessories (2)

Description mm		Reference	Weight kg
Fixing clamps	Ø 12	XSZB112	0.006
	Ø 18	XSZB118	0.010
	Ø 30	XSZB130	0.020

(1) For a 5 m long cable add L1 to the reference; for a 10 m long cable add L2 to the reference.
Example: XS1M18MA250 becomes XS1M18MA250L1 with a 5 m long cable.

(2) For further information, see page 118.

Inductive proximity sensors

XS range, general purpose

Multivoltage sensor, cylindrical, flush mountable and non flush mountable

Two-wire AC or DC, short-circuit protection

Characteristics		XS●M●●M●250K	XS●M●●M●250
Sensor type		UL, CSA, CE	
Product certifications			
Connection		1/2"-20UNF connector	Pre-cabled, length: 2 m
Operating zone	Ø 12 flush mountable	mm	0...1.6
	Ø 12 non flush mountable	mm	0...3.2
	Ø 18 flush mountable	mm	0...4
	Ø 18 non flush mountable	mm	0...6.4
	Ø 30 flush mountable	mm	0...8
	Ø 30 non flush mountable	mm	0...12
Differential travel		%	1...15 of effective sensing distance (Sr)
Degree of protection		Conforming to IEC 60529	IP 67 IP 68, double insulation
Storage temperature		°C	- 40...+ 85
Operating temperature		°C	- 25...+ 70
Materials		Case	Nickel plated brass
	Cable		PvR 2 x 0.34 mm ²
Vibration resistance		Conforming to IEC 60068-2-6	25 gn, amplitude ± 2 mm (f = 10 to 55 Hz)
Shock resistance		Conforming to IEC 60068-2-27	50 gn, duration 11 ms
Indicators	Output state		Yellow LED, 4 viewing ports at 90°
	Supply on		Yellow LED Green LED (only on Ø 18 and Ø 30)
Rated supply voltage		V	~ 24...240 (50/60 Hz) or ~ 24...210
Voltage limits (including ripple)		V	~ or ~ 20...264
Switching capacity		mA	~ 5...300 or ~ 5...200 (except Ø 12: ~ or ~ 5...200) with overload and short-circuit protection
Voltage drop, closed state		V	≤ 5.5
Current consumption, no-load		mA	-
Residual current, open state		mA	≤ 1.5
Maximum switching frequency	Ø 12	Hz	~ 25 or ~ 4000
	Ø 18	Hz	~ 25 or ~ 2000
	Ø 30 flush mountable	Hz	~ 25 or ~ 2000
	Ø 30 non flush mountable	Hz	~ 25 or ~ 1000
Delays	First-up	ms	≤ 70
	Response	ms	≤ 0.2 for Ø 12, ≤ 2 for Ø 18 and Ø 30
	Recovery	ms	≤ 0.2 for Ø 12, ≤ 4 for Ø 18, ≤ 5 for Ø 30 flush mountable, ≤ 10 for Ø 30 non flush mountable

Wiring schemes

1/2"-20UNF connector	Pre-cabled	2-wire ~ or ~
	BU: Blue BN: Brown	NO or NC output
<small>⊕ : on connector models only.</small>		

Setting-up

Sensor	Minimum mounting distances (mm)			
	Side by side	Face to face	Facing a metal object	Mounted in a metal support
Ø 12 flush mountable	e ≥ 4	e ≥ 24	e ≥ 6	d ≥ 12 h ≥ 0
Ø 12 non flush mountable	e ≥ 16	e ≥ 48	e ≥ 12	d ≥ 36 h ≥ 8
Ø 18 flush mountable	e ≥ 10	e ≥ 60	e ≥ 15	d ≥ 18 h ≥ 0
Ø 18 non flush mountable	e ≥ 16	e ≥ 96	e ≥ 24	d ≥ 54 h ≥ 16
Ø 30 flush mountable	e ≥ 20	e ≥ 120	e ≥ 30	d ≥ 30 h ≥ 0
Ø 30 non flush mountable	e ≥ 60	e ≥ 180	e ≥ 45	d ≥ 90 h ≥ 30

Dimensions

Sensor	Flush mountable in metal					Non flush mountable in metal				
	Pre-cabled		Connector		c	Pre-cabled		Connector		c
	a	b	a	b		a	b	a	b	
Ø 12	57	42	66	48	5	57	42	66	42	5
Ø 18	60	51	72	51	8	60	44	72	44	8
Ø 30	60	51	72	51	13	63	41	75	41	13

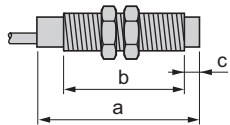

Inductive proximity sensors

XS range, general purpose

Cylindrical, metal and plastic, flush mountable and non flush mountable

Four-wire DC, solid-state NO + NC output

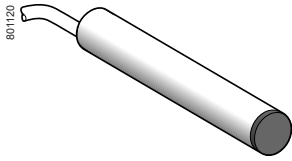

XS1L06●C410

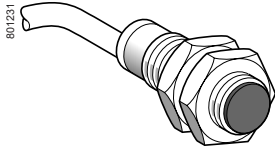

XS1●●●●C410

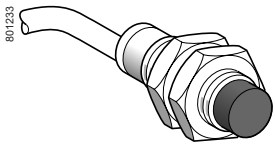

XS2●●●●C410

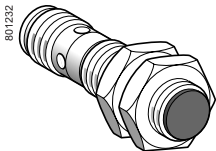

XS1N●●●C410D

Sensing distance (Sn) mm	Function	Output	Connection	Reference	Weight kg
Ø 6.5 plain					
Stainless steel case, flush mountable					
1.5	NO + NC	PNP	Pre-cabled (L = 2 m)	XS1L06PC410	0.025
		NPN	Pre-cabled (L = 2 m)	XS1L06NC410	0.025
Ø 8, threaded M8 x 1					
Stainless steel case, flush mountable					
1.5	NO + NC	PNP	Pre-cabled (L = 2 m)	XS1M08PC410	0.035
			M12 connector	XS1M08PC410D	0.025
		NPN	Pre-cabled (L = 2 m)	XS1M08NC410	0.035
			M12 connector	XS1M08NC410D	0.025
Stainless steel case, non flush mountable					
2.5	NO + NC	NPN	Pre-cabled (L = 2 m)	XS2M08NC410	0.035
			M12 connector	XS2M08NC410D	0.025
Plastic case, non flush mountable					
2.5	NO + NC	PNP (3)	Pre-cabled (L = 2 m) (1)	XS4P08PC410	0.035
Ø 12, threaded M12 x 1					
Brass case, flush mountable					
2	NO + NC	PNP	Pre-cabled (L = 2 m) (1) (2)	XS1N12PC410	0.070
			M12 connector	XS1N12PC410D	0.020
		NPN	Pre-cabled (L = 2 m) (1)	XS1N12NC410	0.070
			M12 connector	XS1N12NC410D	0.020
Plastic case, non flush mountable					
4	NO + NC	PNP (3)	Pre-cabled (L = 2 m) (1)	XS4P12PC410	0.070
			M12 connector	XS4P12PC410D	0.020

(1) For a 5 m long cable add L1 to the reference. Example: XS1N12PC410 becomes XS1N12PC410L1 with a 5 m long cable.

(2) For a 10 m long cable add L2 to the reference. Example: XS1N12PC410 becomes XS1N12PC410L2 with a 10 m long cable.

(3) These sensors can be supplied in NPN versions. Please contact our Customer Care Centre.

Inductive proximity sensors

XS range, general purpose

Cylindrical, metal and plastic, flush mountable and non flush mountable

Four-wire DC, solid-state NO + NC output

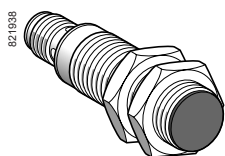

XS●●18●C410

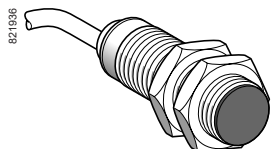

XS●●18●C410D

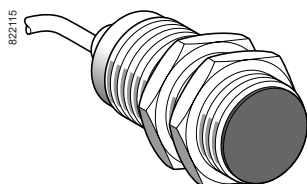

XS●●30●C410

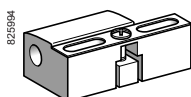

XSZB1●●

Sensing distance (Sn) mm	Function	Output	Connection	Reference	Weight kg
Ø 18, threaded M18 x 1					
Brass case, flush mountable					
5	NO + NC	PNP	Pre-cabled (L = 2 m) (1) (2)	XS1N18PC410	0.100
			M12 connector	XS1N18PC410D	0.040
		NPN	Pre-cabled (L = 2 m)	XS1N18NC410	0.100
			M12 connector	XS1N18NC410D	0.040
Plastic case, non flush mountable					
8	NO + NC	PNP (3)	Pre-cabled (L = 2 m)	XS4P18PC410	0.100
			M12 connector	XS4P18PC410D	0.040
Ø 30, threaded M30 x 1.5					
Brass case, flush mountable					
10	NO + NC	PNP	Pre-cabled (L = 2 m) (1) (2)	XS1N30PC410	0.160
			M12 connector	XS1N30PC410D	0.100
		NPN	Pre-cabled (L = 2 m)	XS1N30NC410	0.160
			M12 connector	XS1N30NC410D	0.100
Plastic case, non flush mountable					
15	NO + NC	PNP (3)	Pre-cabled (L = 2 m)	XS4P30PC410	0.160
			M12 connector	XS4P30PC410D	0.100
Accessories (4)					
Description				Reference	Weight kg
Fixing clamps		Ø 8		XSZB108	0.006
		Ø 12		XSZB112	0.006
		Ø 18		XSZB118	0.010
		Ø 30		XSZB130	0.020

(1) For a 5 m long cable add **L1** to the reference. Example: **XS1N18PC410** becomes **XS1N18PC410L1** with a 5 m long cable.

(2) For a 10 m long cable add **L2** to the reference. Example: **XS1N18PC410** becomes **XS1N18PC410L2** with a 10 m long cable.

(3) These sensors can be supplied in NPN versions. Please contact our Customer Care Centre.

(4) For further information, see page 118.

Inductive proximity sensors

XS range, general purpose

Cylindrical, metal and plastic, flush mountable and non flush mountable

Four-wire DC, solid-state NO + NC output

Characteristics					
Sensor type		XS●●●●PC410D	XS●●●●NC410D	XS●●●●PC410	XS●●●●NC410
Product certifications		UL, CSA, CE, E2 (1)	UL, CSA, CE	UL, CSA, CE, E2 (2)	UL, CSA, CE
Conformity to safety standards	Ø 6.5 and Ø 8	–			
	Ø 12, Ø 18 and Ø 30	EN/IEC 61508: SIL 2 EN/ISO 13849-1: PL=d IEC 62061: SILcl2 (3)	–	EN/IEC 61508: SIL 2 EN/ISO 13849-1: PL=d IEC 62061: SILcl2 (4)	–
Reliability data	Ø 12, Ø 18 and Ø 30	MTTFd = 1829 years, PFHd = 62 10 ⁻⁹ 1/h, SFF > 92 %, DC > 74 % (with a safety controller) (3)	–	MTTFd = 1829 years, PFHd = 62 10 ⁻⁹ 1/h, SFF > 92 %, DC > 74 % (with a safety controller) (4)	–
Connection		M12 connector		Pre-cabled, length: 2 m	
Operating zone	Ø 6.5 and Ø 8 flush mountable	mm	0...1.2		
	Ø 8 non flush mountable	mm	0...2		
	Ø 12 flush mountable	mm	0...1.6		
	Ø 12 non flush mountable	mm	0...3.2		
	Ø 18 flush mountable	mm	0...4		
	Ø 18 non flush mountable	mm	0...6.4		
	Ø 30 flush mountable	mm	0...8		
	Ø 30 non flush mountable	mm	0...12		
Differential travel		%	1...15 of effective sensing distance (Sr)		
Degree of protection	Conforming to IEC 60529		IP 65 and IP 67	IP 67	IP 67, double insulation (Ø 6.5 and Ø 8) IP 68, double insulation (Ø 12, Ø 18 and Ø 30)
	Conforming to DIN 40050		IP 69K (Ø 12, Ø 18 and Ø 30)	–	–
Storage temperature		°C	- 40...+ 85		
Operating temperature		°C	- 25...+ 70 (5)		
Materials	Case		Nickel plated brass for XS1N●●●. Stainless steel 303 for XS1M08●●● and XS2M08●●●. Plastic, PPS, for XS4P●●●.		
	Cable		–		PvR 4 x 0.08 mm ² (Ø 6.5 and Ø 8) PvR 4 x 0.22 mm ² (Ø 12, Ø 18 and Ø 30)
Vibration resistance	Conforming to IEC 60068-2-6		25 gn, amplitude ± 2 mm (f = 10 to 55 Hz)		
Shock resistance	Conforming to IEC 60068-2-27		50 gn, duration 11 ms		
Output state indication			Yellow LED, 4 viewing ports at 90°		Yellow LED, annular
Rated supply voltage		V	--- 12...24 with protection against reverse polarity		
Voltage limits (including ripple)		V	--- 9...36 (--- 10...36 for XS4P●●●)	--- 10...36	--- 9...36 (--- 10...36 for XS4P18●●●)
Switching capacity		mA	≤ 200 with overload and short-circuit protection		
Voltage drop, closed state		V	≤ 2		
Current consumption, no-load		mA	≤ 10		
Maximum switching frequency	Ø 6.5, Ø 8 and Ø 12	Hz	5000		
	Ø 18	Hz	2000		
	Ø 30	Hz	1000		
Delays	First-up	ms	≤ 5		
	Response	ms	≤ 0.1 for Ø 8 and Ø 12, ≤ 0.15 for Ø 18, ≤ 0.3 for Ø 30		
	Recovery	ms	≤ 0.1 for Ø 8 and Ø 12, ≤ 0.35 for Ø 18, ≤ 0.7 for Ø 30		

(1) Except XS4P●●●: UL, CSA and CE.

(2) Except XS4P18●●●: UL, CSA and CE.

(3) Except XS4P●●●.

(4) Except XS4P18●●●.

(5) Sensors are available for very low temperatures (suffix TF: -40°C, + 70°C) or very high temperatures (suffix TT: - 25°C, + 85°C). Please consult our Customer Care Centre.

Inductive proximity sensors

XS range, general purpose

Cylindrical, metal and plastic, flush mountable and non flush mountable

Four-wire DC, solid-state NO + NC output

Wiring schemes

M12 connector



Pre-cabled

BU: Blue
BN: Brown
BK: Black
WH: White

PNP 4-wire

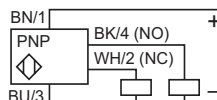

NPN 4-wire

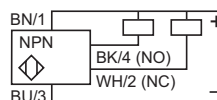

Setting-up

Minimum mounting distances (mm)

Sensor	Side by side	Face to face	Facing a metal object	Mounted in a metal support
Ø 6.5 flush mountable XS1L06	$e \geq 3$	$e \geq 18$	$e \geq 4.5$	$d \geq 6.5$ $h \geq 0$
Ø 8 flush mountable XS1M08	$e \geq 3$	$e \geq 18$	$e \geq 4.5$	$d \geq 8$ $h \geq 0$
Ø 8 non flush mountable XS4P08	$e \geq 10$	$e \geq 30$	$e \geq 7.5$	$d \geq 24$ $h \geq 5$
Ø 12 flush mountable XS1N12	$e \geq 4$	$e \geq 24$	$e \geq 6$	$d \geq 12$ $h \geq 0$
Ø 12 non flush mountable XS4P12	$e \geq 16$	$e \geq 48$	$e \geq 12$	$d \geq 36$ $h \geq 8$
Ø 18 flush mountable XS1N18	$e \geq 10$	$e \geq 60$	$e \geq 15$	$d \geq 18$ $h \geq 0$
Ø 18 non flush mountable XS4P18	$e \geq 16$	$e \geq 96$	$e \geq 24$	$d \geq 54$ $h \geq 16$
Ø 30 flush mountable XS1N30	$e \geq 20$	$e \geq 120$	$e \geq 30$	$d \geq 30$ $h \geq 0$
Ø 30 non flush mountable XS4P30	$e \geq 60$	$e \geq 180$	$e \geq 45$	$d \geq 90$ $h \geq 30$

Dimensions

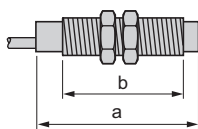

Flush mountable in metal

Sensor	Pre-cabled (mm)		M12 connector (mm)	
	a	b	a	b
Ø 6.5 XS1L06 stainless steel	50	-	-	-
Ø 8 XS1M08 stainless steel	51	42	62	40
Ø 12 XS1N12 brass	37	25	50	31
Ø 18 XS1N18 brass	41	29	51	28
Ø 30 XS1N30 brass	45	33	54	33

Non flush mountable in metal

Sensor	Pre-cabled (mm)		M12 connector (mm)	
	a	b	a	b
Ø 8 XS2M08 stainless steel	54	42	65	40
Ø 8 XS4P08 plastic	34	25	-	-
Ø 12 XS4P12 plastic	37	25	50	31
Ø 18 XS4P18 plastic	41	29	51	28
Ø 30 XS4P30 plastic	45	33	54	33

Inductive proximity sensors

XS range, general purpose

Cylindrical, metal, increased range, flush mountable

Four-wire DC, solid-state NO + NC output

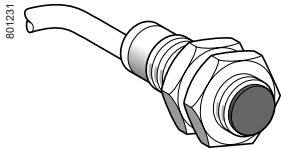

XS1●●B3PCL2

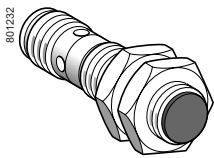

XS112B3PCM12

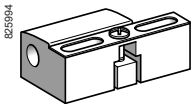

XSZB●●●

Sensors, 4-wire

Sensing distance (Sn) mm	Function	Output	Connection	Reference	Weight kg
Ø 8, threaded M8 x 1					
2.5	NO + NC	PNP	Pre-cabled (L = 2 m)	XS608B1PCL2	0.035
			M12 connector	XS608B1PCM12	0.025

Ø 12, threaded M12 x 1					
4	NO + NC	PNP	Pre-cabled (L = 2 m)	XS112B3PCL2	0.070
			M12 connector	XS112B3PCM12	0.020

Ø 18, threaded M18 x 1					
8	NO + NC	PNP	Pre-cabled (L = 2 m)	XS118B3PCL2	0.100
			M12 connector	XS118B3PCM12	0.040

Ø 30, threaded M30 x 1.5					
15	NO + NC	PNP	Pre-cabled (L = 2 m)	XS130B3PCL2	0.160
			M12 connector	XS130B3PCM12	0.100

Accessories (1)

Description	For use with sensors	Reference	Weight kg
Fixing clamps	Ø 8	XSZB108	0.006
	Ø 12	XSZB112	0.006
	Ø 18	XSZB118	0.010
	Ø 30	XSZB130	0.020

(1) For further information, see page 118.

Inductive proximity sensors

XS range, general purpose

Cylindrical, metal, increased range, flush mountable

Four-wire DC, solid-state NO + NC output

Characteristics		XS1●●B3PCM12 / XS608B1PCM12	XS1●●B3PCL2 / XS608B1PCL2
Sensor type			
Product certifications		UL, CSA, CE, E2	
Conformity to safety standards only for Ø 12 to Ø 30		EN/IEC 61508: SIL 2 EN/ISO 13849-1: PL = d IEC 62061: SILcl2	
Reliability data only for Ø 12 to Ø 30		MTTFd = 1829 years, PFHd = 62 10 ⁻⁹ 1/h, SFF > 92 %, DC > 74 % (with a safety controller)	
Connection	Connector	M12	–
	Pre-cabled	–	Length 2 m
Operating zone (1)	Ø 8	mm	0...2
	Ø 12	mm	0...3.2
	Ø 18	mm	0...6.4
	Ø 30	mm	0...12
Differential travel		%	
Degree of protection		%	
Conforming to IEC 60529	IP 65 and IP 67		IP 65 and IP 68, double insulation □
	Conforming to DIN 40050		IP 69K
Storage temperature		°C	
Operating temperature		°C	
Materials	Case	Nickel plated brass for Ø 12 to Ø 30, stainless steel grade 303 for Ø 8	
	Sensing face	PPS	
	Cable	–	PvR 4 x 0.22 mm ² except Ø 8: 4 x 0.08 mm ²
Vibration resistance	Conforming to IEC 60068-2-6	25 gn, amplitude ± 2 mm (f = 10 to 55 Hz)	
Shock resistance	Conforming to IEC 60068-2-27	50 gn, duration 11 ms	
Output state indication		Yellow LED, 4 viewing ports at 90°	Yellow LED, annular
Rated supply voltage		V	
Voltage limits (including ripple)		V	
Switching capacity		mA	
Voltage drop, closed state		V	
Current consumption, no-load		mA	
Maximum switching frequency	Ø 8 and Ø 12	Hz	
	Ø 18	Hz	
	Ø 30	Hz	
Delays	First-up	ms	
	Response	ms	
	Recovery	ms	

Wiring schemes

M12 connector



Pre-cabled

BU: Blue
BN: Brown
BK: Black
WH: White

PNP 4-wire

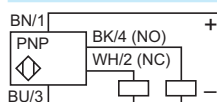

Setting-up

Minimum mounting distances (mm)

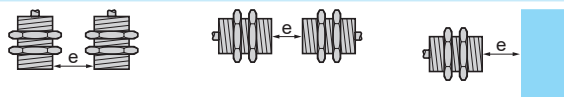

Sensors	Side by side	Face to face	Facing a metal object
Ø 8	e ≥ 5	e ≥ 30	e ≥ 8
Ø 12	e ≥ 8	e ≥ 50	e ≥ 12
Ø 18	e ≥ 16	e ≥ 100	e ≥ 25
Ø 30	e ≥ 30	e ≥ 180	e ≥ 45

Dimensions

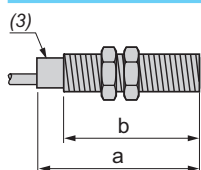

Sensors	Pre-cabled (mm)		M12 connector (mm)	
	a	b	a	b
Ø 8	51	42	61	40
Ø 12	37	25	50	31
Ø 18	41	29	51	28
Ø 30	45	33	54	33

(1) Detection curves, see page 122.

(2) Sensors are available for very low temperatures (suffix TF: -40°C, +70°C) or very high temperatures (suffix TT: -25°C, +85°C). Please consult our Customer Care Centre.

(3) LED.

Inductive proximity sensors

XS range, general purpose

Cylindrical, metal and plastic, flush and non flush mountable

Four-wire DC, solid-state PNP + NPN NO/NC programmable output

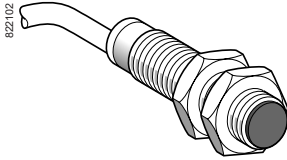

XS1M●●KP340
XS4P●●KP340

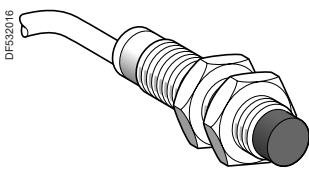

XS2M●●KP340

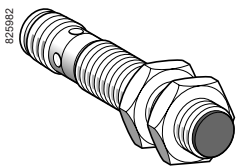

XS1M●●KP340D
XS4P●●KP340D

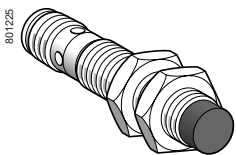

XS2M●●KP340D

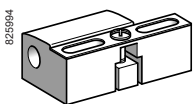

XSZB1●●

Sensing distance (Sn) mm	Function	Output	Connection	Reference	Weight kg
Ø 12, threaded M12 x 1					
Metal case, flush mountable					
2	NO/NC programmable	PNP + NPN	Pre-cabled (L = 2 m) (1) M12 connector	XS1M12KP340 XS1M12KP340D	0.075 0.025
Metal case, non flush mountable					
4	NO/NC programmable	PNP + NPN	Pre-cabled (L = 2 m) (1) M12 connector	XS2M12KP340 XS2M12KP340D	0.075 0.025
Plastic case, non flush mountable					
4	NO/NC programmable	PNP + NPN	Pre-cabled (L = 2 m) (1) M12 connector	XS4P12KP340 XS4P12KP340D	0.075 0.025
Ø 18, threaded M18 x 1					
Metal case, flush mountable					
5	NO/NC programmable	PNP + NPN	Pre-cabled (L = 2 m) (1) M12 connector	XS1M18KP340 XS1M18KP340D	0.120 0.060
Metal case, non flush mountable					
8	NO/NC programmable	PNP + NPN	Pre-cabled (L = 2 m) (1) M12 connector	XS2M18KP340 XS2M18KP340D	0.120 0.060
Plastic case, non flush mountable					
8	NO/NC programmable	PNP + NPN	Pre-cabled (L = 2 m) (1) M12 connector	XS4P18KP340 XS4P18KP340D	0.120 0.060
Ø 30, threaded M30 x 1.5					
Metal case, flush mountable					
10	NO/NC programmable	PNP + NPN	Pre-cabled (L = 2 m) (1) M12 connector	XS1M30KP340 XS1M30KP340D	0.205 0.145
Metal case, non flush mountable					
15	NO/NC programmable	PNP + NPN	Pre-cabled (L = 2 m) (1) M12 connector	XS2M30KP340 XS2M30KP340D	0.205 0.145
Plastic case, non flush mountable					
15	NO/NC programmable	PNP + NPN	Pre-cabled (L = 2 m) (1) M12 connector	XS4P30KP340 XS4P30KP340D	0.205 0.145
Accessories (2)					
Description mm				Reference	Weight kg
Fixing clamps		Ø 12		XSZB112	0.006
		Ø 18		XSZB118	0.010
		Ø 30		XSZB130	0.020

(1) For a 5 m long cable add L1 to the reference; for a 10 m long cable add L2 to the reference.
Example: XS1M12KP340 becomes XS1M12KP340L1 with a 5 m long cable.

(2) For further information, see page 118.

Inductive proximity sensors

XS range, general purpose

Cylindrical, metal and plastic, flush and non flush mountable

Four-wire DC, solid-state PNP + NPN NO/NC

programmable output

Characteristics		XS●M●●KP340D	XS●M●●KP340
Sensor type			
Product certifications		UL, CSA, CE	
Connection		M12 connector	Pre-cabled, length: 2 m
Operating zone	Ø 12 flush mountable	mm	0...1.6
	Ø 12 non flush mountable	mm	0...3.2
	Ø 18 flush mountable	mm	0...4
	Ø 18 non flush mountable	mm	0...6.4
	Ø 30 flush mountable	mm	0...8
	Ø 30 non flush mountable	mm	0...12
Differential travel		%	1...15 of effective sensing distance (Sr)
Degree of protection		Conforming to IEC 60529	IP 67 IP 68, double insulation
Storage temperature		°C	- 40...+ 85
Operating temperature		°C	- 25...+ 70
Materials		Case	Nickel plated brass for XS1M and XS2M, PPS for XS4P
	Cable	-	PvR 4 x 0.34 mm ²
Vibration resistance		Conforming to IEC 60068-2-6	25 gn, amplitude ± 2 mm (f = 10 to 55 Hz)
Shock resistance		Conforming to IEC 60068-2-27	50 gn, duration 11 ms
Output state indication			Yellow LED, 4 viewing ports at 90° Yellow LED, annular
Rated supply voltage		V	--- 12...24 with protection against reverse polarity
Voltage limits (including ripple)		V	--- 10...36
Switching capacity		mA	≤ 200 with overload and short-circuit protection
Voltage drop, closed state		V	≤ 2.6
Current consumption, no-load		mA	≤ 10
Maximum switching frequency	Ø 12	Hz	5000
	Ø 18	Hz	2000
	Ø 30 flush mountable	Hz	1000
	Ø 30 non flush mountable	Hz	1000
Delays	First-up	ms	≤ 5
	Response	ms	≤ 0.1 for Ø 12, ≤ 0.15 for Ø 18, ≤ 0.3 for Ø 30
	Recovery	ms	≤ 0.1 for Ø 12, ≤ 0.35 for Ø 18, ≤ 0.7 for Ø 30

Wiring schemes

M12 connector



Pre-cabled

BU: Blue
BN: Brown
BK: Black
WH: White

PNP + NPN

4-wire programmable, NO or NC output

PNP

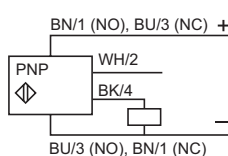

NPN

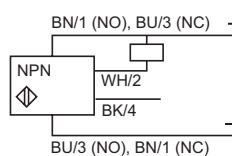

Setting-up

Minimum mounting distances (mm)

Sensor	Side by side	Face to face	Facing a metal object	Mounted in a metal support
Ø 12 flush mountable XS1M12	$e \geq 4$	$e \geq 24$	$e \geq 6$	$d \geq 12$ $h \geq 0$
Ø 12 non flush mountable XS2M12 and XS4P12	$e \geq 16$	$e \geq 48$	$e \geq 12$	$d \geq 36$ $h \geq 8$
Ø 18 flush mountable XS1M18	$e \geq 10$	$e \geq 60$	$e \geq 15$	$d \geq 18$ $h \geq 0$
Ø 18 non flush mountable XS2M18 and XS4P18	$e \geq 16$	$e \geq 96$	$e \geq 24$	$d \geq 54$ $h \geq 16$
Ø 30 flush mountable XS1M30	$e \geq 20$	$e \geq 120$	$e \geq 30$	$d \geq 30$ $h \geq 0$
Ø 30 non flush mountable XS2M30 and XS4P30	$e \geq 60$	$e \geq 180$	$e \geq 45$	$d \geq 90$ $h \geq 30$

Dimensions

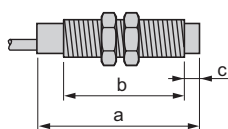

Sensor	Flush mountable in metal				Non flush mountable in metal				
	Pre-cabled		Connector		Pre-cabled		Connector		c
	a	b	a	b	a	b	a	b	
Ø 12 metal	54	42	61	42	55	42	66	42	5
Ø 12 plastic	-	-	-	-	54	42	61	43	0
Ø 18 metal	60	51	72	51	60	44	72	44	8
Ø 18 plastic	-	-	-	-	60	51	70	51	0
Ø 30 metal	60	51	72	51	63	41	75	41	13
Ø 30 plastic	-	-	-	-	60	51	70	51	0

Inductive proximity sensors

XS range, general purpose
Plastic, cylindrical, non flush mountable
Two-wire AC or DC
Three-wire DC, solid-state output

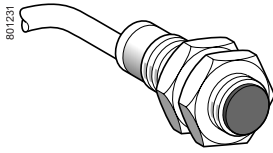

XS4P●●●●340
XS4P●●●●370
XS4P●●●●230

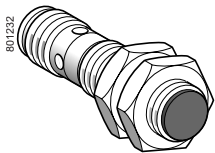

XS4P●●●●340D
XS4P●●●●370D
XS4P●●●●230K

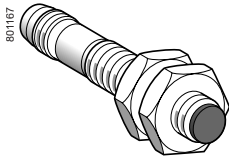

XS4P08●●●340S

Sensing dist. (Sn) mm	Function	Output	Connection	Reference	Weight kg
Ø 8, threaded M8 x 1					
Three-wire --- 12-24 V					
2.5	NO	PNP	Pre-cabled (L = 2 m) (1) (2)	XS4P08PA340	0.025
		NPN	Pre-cabled (L = 2 m) (1) (2)	XS4P08NA340	0.025
	NC	PNP	Pre-cabled (L = 2 m) (1) (2)	XS4P08PB340	0.025
		NPN	Pre-cabled (L = 2 m) (1) (2)	XS4P08NB340	0.025
Three-wire --- 12-48 V					
2.5	NO	PNP	Pre-cabled (L = 2 m) (1)	XS4P08PA370	0.030
Two-wire ~ or --- 24-240 V					
2.5	NO		Pre-cabled (L = 2 m) (1)	XS4P08MA230	0.030
			1/2"-20UNF connector	XS4P08MA230K	0.020
	NC		Pre-cabled (L = 2 m) (1)	XS4P08MB230	0.030
			1/2"-20UNF connector	XS4P08MB230K	0.020
Ø 12, threaded M12 x 1					
Three-wire --- 12-24 V					
4	NO	PNP	Pre-cabled (L = 2 m) (1) (3)	XS4P12PA340	0.060
		NPN	Pre-cabled (L = 2 m) (1) (3)	XS4P12NA340	0.060
	NC	PNP	Pre-cabled (L = 2 m) (1) (3)	XS4P12PB340	0.060
		NPN	Pre-cabled (L = 2 m) (1) (3)	XS4P12NB340	0.060
Three-wire --- 12-48 V					
4	NO	PNP	Pre-cabled (L = 2 m) (1) (3)	XS4P12PA370	0.065
		NPN	Pre-cabled (L = 2 m) (1) (3)	XS4P12NA370	0.065
	NC	PNP	Pre-cabled (L = 2 m) (1) (3)	XS4P12PB370	0.065
		NPN	Pre-cabled (L = 2 m) (3)	XS4P12NB370	0.065
Two-wire ~ or --- 24-240 V					
4	NO		Pre-cabled (L = 2 m) (1)	XS4P12MA230	0.065
			1/2"-20UNF connector	XS4P12MA230K	0.030
	NC		Pre-cabled (L = 2 m) (1)	XS4P12MB230	0.065
			1/2"-20UNF connector	XS4P12MB230K	0.030
Ø 18, threaded M18 x 1					
Three-wire --- 12-24 V					
8	NO	PNP	Pre-cabled (L = 2 m) (1) (3)	XS4P18PA340	0.090
		NPN	Pre-cabled (L = 2 m) (1) (3)	XS4P18NA340	0.090
	NC	PNP	Pre-cabled (L = 2 m) (1) (3)	XS4P18PB340	0.090
		NPN	Pre-cabled (L = 2 m) (1) (3)	XS4P18NB340	0.090
Three-wire --- 12-48 V					
8	NO	PNP	Pre-cabled (L = 2 m) (1) (3)	XS4P18PA370	0.100
		NPN	Pre-cabled (L = 2 m) (1) (3)	XS4P18NA370	0.100
	NC	PNP	Pre-cabled (L = 2 m) (1) (3)	XS4P18PB370	0.100
		NPN	Pre-cabled (L = 2 m) (3)	XS4P18NB370	0.100
Two-wire ~ or --- 24-240 V					
8	NO		Pre-cabled (L = 2 m) (1)	XS4P18MA230	0.100
			1/2"-20UNF connector	XS4P18MA230K	0.040
	NC		Pre-cabled (L = 2 m) (1)	XS4P18MB230	0.100
			1/2"-20UNF connector	XS4P18MB230K	0.040
Ø 30, threaded M30 x 1.5					
Three-wire --- 12-24 V					
15	NO	PNP	Pre-cabled (L = 2 m) (1) (3)	XS4P30PA340	0.120
		NPN	Pre-cabled (L = 2 m) (1) (3)	XS4P30NA340	0.120
	NC	PNP	Pre-cabled (L = 2 m) (1) (3)	XS4P30PB340	0.120
		NPN	Pre-cabled (L = 2 m) (1) (3)	XS4P30NB340	0.120
Three-wire --- 12-48 V					
15	NO	PNP	Pre-cabled (L = 2 m) (1) (3)	XS4P30PA370	0.140
		NPN	Pre-cabled (L = 2 m) (1) (3)	XS4P30NA370	0.140
	NC	PNP	Pre-cabled (L = 2 m) (3)	XS4P30PB370	0.140
		NPN	Pre-cabled (L = 2 m) (3)	XS4P30NB370	0.140
Two-wire ~ or ---					
15	NO		Pre-cabled (L = 2 m) (1)	XS4P30MA230	0.140
			1/2"-20UNF connector	XS4P30MA230K	0.080
	NC		Pre-cabled (L = 2 m) (1)	XS4P30MB230	0.140
			1/2"-20UNF connector	XS4P30MB230K	0.080

(1) For a 5 m long cable add L1 to the reference; for a 10 m long cable add L2 to the reference. Example: **XS4P08PA340** becomes **XS4P08PA340L1** with a 5 m long cable.

(2) For an M8 connector, add S to the reference. Example: **XS4P08PA340** becomes **XS4P08PA340S** with an M8 connector.

(3) For an M12 connector, add D to the reference. Example: **XS4P12PA370** becomes **XS4P12PA370D** with an M12 connector.

Inductive proximity sensors

XS range, general purpose

Plastic, cylindrical, non flush mountable

Two-wire AC or DC

Three-wire DC, solid-state output

Characteristics		XS4P●●●●340●	XS4P●●●●370●	XS4P●●M●230●
Sensor type		UL, CSA, CE, ECOLAB		
Product certifications		UL, CSA, CE, ECOLAB		
Connection	Pre-cabled	Length: 2 m		
	Connector	M8 on Ø 8 M12 on Ø 12, Ø 18 and Ø 30		1/2"-20UNF
Operating zone	Ø 8	mm	0...2	
	Ø 12	mm	0...3.2	
	Ø 18	mm	0...6.4	
	Ø 30	mm	0...12	
Differential travel		%	1...15 of effective sensing distance (Sr)	
Degree of protection		Conforming to IEC 60529	IP 68, double insulation for pre-cabled version (except Ø 8: IP 67) IP 67 for connector version	
Storage temperature		°C	- 40...+ 85	
Operating temperature		°C	- 25...+ 70	
Materials	Case	PPS		
	Cable	PvR 3 x 0.34 mm ² except Ø 8: 3 x 0.11 mm ²		PvR 2 x 0.34 mm ² except Ø 8: 2 x 0.11 mm ²
Vibration resistance		Conforming to IEC 60068-2-6	25 gn, amplitude ± 2 mm (f = 10 to 55 Hz)	
Shock resistance		Conforming to IEC 60068-2-27	50 gn, duration 11 ms	
Output state indication		Yellow LED: annular on pre-cabled version Yellow LED: 4 viewing ports at 90° on connector version		
Rated supply voltage		V	~ 12...24 with protection against reverse polarity	~ 12...48 with protection against reverse polarity ~ or ~ 24...240 (50/60 Hz)
Voltage limits (including ripple)		V	~ 10...36	~ 10...58 ~ or ~ 20...264
Switching capacity		mA	≤ 200 with overload and short-circuit protection 5...100 for Ø 8, 5...200 for Ø 12, 5...200 ~ and 5...300 ~ for Ø 18 and 30	
Voltage drop, closed state		V	≤ 2	
Residual current, open state		mA	-	
Current consumption, no-load		mA	≤ 10	
Maximum switching frequency	Ø 8 and Ø 12	Hz	5000	
	Ø 18	Hz	2000	
	Ø 30	Hz	1000	
Delays	First-up	ms	≤ 10	
	Response	ms	≤ 0.1 for Ø 8 and Ø 12, ≤ 0.15 for Ø 18, ≤ 0.3 for Ø 30	
	Recovery	ms	≤ 0.1 for Ø 8 and Ø 12, ≤ 0.35 for Ø 18, ≤ 0.7 for Ø 30	

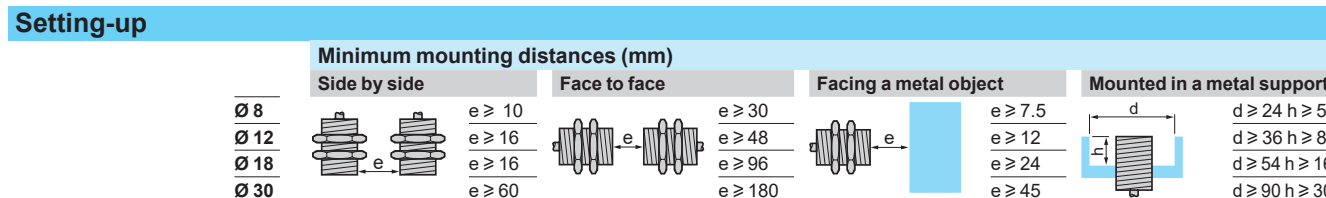
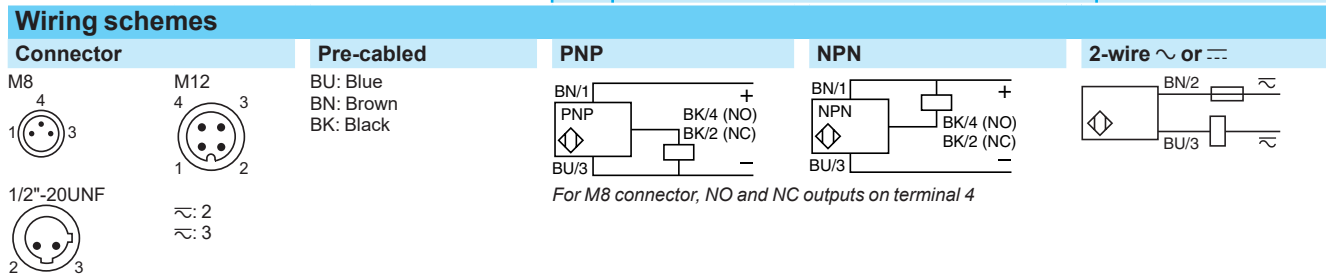

Dimensions

XS4P	3-wire ~ 12-24 V				3-wire ~ 12-48 V or 2-wire ~/~ 24-240 V			
	Pre-cabled (mm)		Connector (mm)		Pre-cabled (mm)		Connector (mm)	
	a	b	a	b	a	b	a	b
Ø 8	33	26	42	26	50	42	61	40
Ø 12	35	25	48	27	54	42	61	42
Ø 18	36	25	48	29	62	52	70	52
Ø 30	43	32	50	34	62	52	70	52

Inductive proximity sensors

XS range, general purpose

Cylindrical, almost flush mountable, increased range

Three-wire DC, solid-state output

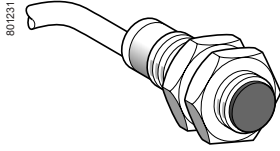

XS1N●●●●349

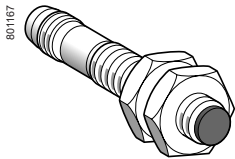

XS1N08●●●349S

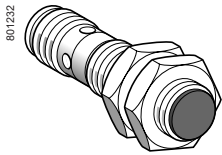

XS1N●●●●349D

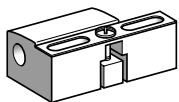

XSZB1●●

References

Sensing distance (Sn) (mm)	Function	Output	Connection	Reference	Weight kg
Ø 8, threaded M8 x 1					
2.5	NO	PNP	Pre-cabled (L = 2 m)	XS1N08PA349	0.035
			M8 connector	XS1N08PA349S	0.015
			M12 connector	XS1N08PA349D	0.020
NC	PNP	Pre-cabled (L = 2 m)	XS1N08PB349	0.035	
		M8 connector	XS1N08PB349S	0.015	
		M12 connector	XS1N08PB349D	0.020	
Ø 12, threaded M12 x 1					
4	NO	PNP	Pre-cabled (L = 2 m)	XS1N12PA349	0.070
			M12 connector	XS1N12PA349D	0.020
			NPN	Pre-cabled (L = 2 m)	XS1N12NA349
		M12 connector	XS1N12NA349D	0.020	
	NC	PNP	Pre-cabled (L = 2 m)	XS1N12PB349	0.070
			M12 connector	XS1N12PB349D	0.020
NPN			Pre-cabled (L = 2 m)	XS1N12NB349	0.070
	M12 connector	XS1N12NB349D	0.020		
Ø 18, threaded M18 x 1					
10	NO	PNP	Pre-cabled (L = 2 m)	XS1N18PA349	0.100
			M12 connector	XS1N18PA349D	0.040
			NPN	Pre-cabled (L = 2 m)	XS1N18NA349
		M12 connector	XS1N18NA349D	0.040	
	NC	PNP	Pre-cabled (L = 2 m)	XS1N18PB349	0.100
			M12 connector	XS1N18PB349D	0.040
NPN			Pre-cabled (L = 2 m)	XS1N18NB349	0.100
	M12 connector	XS1N18NB349D	0.040		
Ø 30, threaded M30 x 1.5					
20	NO	PNP	Pre-cabled (L = 2 m)	XS1N30PA349	0.160
			M12 connector	XS1N30PA349D	0.100
			NPN	Pre-cabled (L = 2 m)	XS1N30NA349
		M12 connector	XS1N30NA349D	0.100	
	NC	PNP	Pre-cabled (L = 2 m)	XS1N30PB349	0.160
			M12 connector	XS1N30PB349D	0.100
NPN			Pre-cabled (L = 2 m)	XS1N30NB349	0.160
	M12 connector	XS1N30NB349D	0.100		

Accessories (1)

Description mm	Reference	Weight kg	
Fixing clamps	Ø 8	XSZB108	0.006
	Ø 12	XSZB112	0.006
	Ø 18	XSZB118	0.010
	Ø 30	XSZB130	0.020

(1) For further information, see page 118.

Characteristics		XS1.....349D	XS1.....349S	XS1.....349
Sensor type		UL, CSA, CE		
Product certifications		UL, CSA, CE		
Connection		M12 connector	M8 connector	Pre-cabled, length: 2 m
Operating zone	Ø 8	mm	0...2	
	Ø 12	mm	0...3.2	
	Ø 18	mm	0...8	
	Ø 30	mm	0...16	
Differential travel		%	1...15 of effective sensing distance (Sr)	
Degree of protection	Conforming to IEC 60529	IP 67		IP 68, double insulation (except Ø 8: IP 67)
	Conforming to DIN 40050	IP 69K for Ø 12 to Ø 30		
Storage temperature		°C	- 40...+ 85	
Operating temperature		°C	- 25...+ 70	
Materials	Case	Nickel plated brass		
	Cable	-		
Vibration resistance		Conforming to IEC 60068-2-6	25 gn, amplitude ± 2 mm (f = 10 to 55 Hz)	
Shock resistance		Conforming to IEC 60068-2-27	50 gn, duration 11 ms	
Output state indication		Yellow LED, 4 viewing ports at 90°		Yellow LED, annular
Rated supply voltage		V	12...24 with protection against reverse polarity	
Voltage limits (including ripple)		V	10...36	
Switching capacity		mA	≤ 200 with overload and short-circuit protection	
Voltage drop, closed state		V	≤ 2	
Current consumption, no-load		mA	≤ 10	
Maximum switching frequency	Ø 8 and Ø 12	Hz	2500	
	Ø 18	Hz	1000	
	Ø 30	Hz	500	
Delays	First-up	ms	≤ 5	
	Response	ms	≤ 0.2 for Ø 8 and Ø 12, ≤ 0.3 for Ø 18, ≤ 0.6 for Ø 30	
	Recovery	ms	≤ 0.2 for Ø 8 and Ø 12, ≤ 0.7 for Ø 18, ≤ 1.4 for Ø 30	

Wiring schemes

Connector	Pre-cabled	PNP 3-wire	NPN 3-wire
M8 	M12 	BU: Blue BN: Brown BK: Black	

For M8 connector, NO and NC outputs on terminal 4

Setting-up precautions

Sensor	Minimum mounting distances (mm)			
	Side by side	Face to face	Facing a metal object	Mounted in a metal support
Ø 8	e ≥ 5	e ≥ 30	e ≥ 7.5	d ≥ 10 h ≥ 1.6
Ø 12	e ≥ 8	e ≥ 48	e ≥ 12	d ≥ 14 h ≥ 2.4
Ø 18	e ≥ 20	e ≥ 96	e ≥ 30	d ≥ 28 h ≥ 3.6
Ø 30	e ≥ 40	e ≥ 240	e ≥ 60	d ≥ 50 h ≥ 6

Dimensions

Sensor	Flush mountable in metal					
	Pre-cabled		M8 connector		M12 connector	
	a	b	a	b	a	b
Ø 8	33	25	42	26	45	23
Ø 12	35	25	-	-	50	30
Ø 18	39	28	-	-	50	28
Ø 30	43	32	-	-	55	32

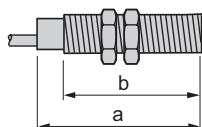

Inductive proximity sensors

XS range, general purpose

Miniature, cylindrical, flush mountable

Three-wire DC, solid-state output

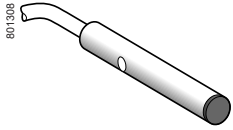

XS1L04●●310

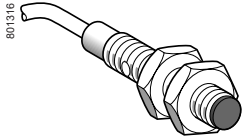

XS1N05●●310

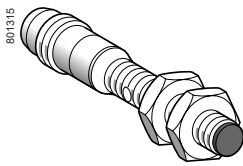

XS1N05●●311S

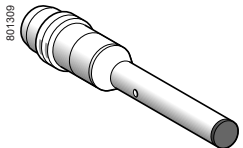

XS1L04●●310S

Ø 4 plain (1)

Sensing distance (Sn) mm	Function	Output	Connection (2)	Reference	Weight kg
Brass case, flush mountable					
1	NO	PNP	Pre-cabled (L = 2 m)	XS1L04PA310	0,025
			M8 connector	XS1L04PA310S	0.010
	NPN	PNP	Pre-cabled (L = 2 m)	XS1L04NA310	0.025
			M8 connector	XS1L04NA310S	0.010
	NC	PNP	Pre-cabled (L = 2 m)	XS1L04PB310	0.025
			M8 connector	XS1L04PB310S	0.010
NPN	PNP	Pre-cabled (L = 2 m)	XS1L04NB310	0.025	
		M8 connector	XS1L04NB310S	0.010	

Stainless steel case, flush mountable

0,8	NO	PNP	Pre-cabled (L = 2 m)	XS1L04PA311	0.025
			M8 connector	XS1L04PA311S	0.010
	NPN	PNP	Pre-cabled (L = 2 m)	XS1L04NA311	0.025
			M8 connector	XS1L04NA311S	0.010
	NC	PNP	Pre-cabled (L = 2 m)	XS1L04PB311	0.025
			M8 connector	XS1L04PB311S	0,010
NPN	PNP	Pre-cabled (L = 2 m)	XS1L04NB311	0.025	
		M8 connector	XS1L04NB311S	0.010	

Ø 5, threaded M5 x 0.5 (1)

Sensing distance (Sn) mm	Function	Output	Connection (2)	Reference	Weight kg
Brass case, flush mountable					
1	NO	PNP	Pre-cabled (L = 2 m)	XS1N05PA310	0,030
			NPN	Pre-cabled (L = 2 m)	XS1N05NA310
	NC	PNP	Pre-cabled (L = 2 m)	XS1N05PB310	0,030
			NPN	Pre-cabled (L = 2 m)	XS1N05NB310

Stainless steel case, flush mountable

0.8	NO	PNP	Pre-cabled (L = 2 m)	XS1N05PA311	0.030
			M8 connector	XS1N05PA311S	0.015
	NPN	PNP	Pre-cabled (L = 2 m)	XS1N05NA311	0.030
			M8 connector	XS1N05NA311S	0.015
	NC	PNP	Pre-cabled (L = 2 m)	XS1N05PB311	0.030
			M8 connector	XS1N05PB311S	0.015
NPN	PNP	Pre-cabled (L = 2 m)	XS1N05NB311	0.030	
		M8 connector	XS1N05NB311S	0.015	

(1) For accessories, see page 118.

(2) For a 5 m long cable add L1 to the reference; for a 10 m long cable add L2 to the reference.
Example: XS1L04PA310 becomes XS1L04PA310L1 with a 5 m long cable.

Inductive proximity sensors

XS range, general purpose
Miniature, cylindrical, flush mountable
Three-wire DC, solid-state output

Characteristics		XS1●●●●●●●S	XS1●●●●●●●
Sensor type			
Product certifications		UL, CSA, CÉ	
Connection (1)	Connector	M8 on XS1●●●●●●●S	–
	Pre-cabled	–	Length: 2 m
Operating zone	∅ 4	mm	0...0.8 (brass), 0...0.6 (stainless steel)
	∅ 5	mm	0...0.8 (brass), 0...0.6 (stainless steel)
Degree of protection	Conforming to IEC 60529		IP 67
Storage temperature		°C	- 40...+ 85
Operating temperature		°C	- 25...+ 70
Materials	Case		Nickel plated brass or stainless steel 303
	Cable		PvR 3 x 0.11 mm ²
Vibration resistance	Conforming to IEC 60068-2-6		25 gn, amplitude ± 2 mm (f = 10 to 55 Hz)
Shock resistance	Conforming to IEC 60068-2-27		50 gn, duration 11 ms
Output state indication			Yellow LED, 4 viewing ports at 90° Yellow LED, annular
Rated supply voltage		V	--- 5...24 for XS1L04●●●●●●● and XS1N05●●●●●●●
Voltage limits (including ripple)		V	--- 5...30 for XS1L04●●●●●●● and XS1N05●●●●●●●
Current consumption, no-load		mA	≤ 10
Switching capacity	3-wire PNP/NPN	mA	≤ 100 with overload and short-circuit protection
Voltage drop, closed state		V	≤ 2
Maximum switching frequency		kHz	5
Delays	First-up	ms	≤ 5
	Response	ms	≤ 0.1
	Recovery	ms	≤ 0.1

(1) Detection curves, see page 122

Wiring schemes

Connector	Pre-cabled	PNP 3-wire	NPN 3-wire
M8 	BU: Blue BN: Brown BK: Black		

Setting-up

Minimum mounting distances (mm)

Sensor	Side by side	Face to face	Facing a metal object
∅ 4	e ≥ 2	e ≥ 12	e ≥ 3, d1 ≥ 4, h ≥ 0
∅ 5	e ≥ 2	e ≥ 12	e ≥ 3, d1 ≥ 5, h ≥ 0

Tightening torque

Stainless steel: 2.2 N.m. Brass: 1.6 N.m (values obtained with washers mounted)

Dimensions

Sensor	Pre-cabled		M8 connector	
	a	b	a	b
∅ 4	28	–	43	–
∅ 5	28	24	43	24

Inductive proximity sensors

XS range

Flush mountability using teach mode: simplicity through innovation

Operating principle

In proposing flush mountable sensors using teach mode, Telemecanique Sensors offers simplicity through innovation.

■ A single product enables flush mounting using teach mode and meets all the requirements for inductive detection of metal objects. By simply pressing the “Teach mode” button, the sensor automatically acquires optimum configuration for all detection, flush mountability and environment requirements.

■ Other advantages of flush mountable sensors using teach mode

- Increased performance:
 - sensing distance guaranteed and optimised irrespective of the mounting method, object, environment or background,
 - suitable for all metal environments.
- Simplified use provided by:
 - the flush mountability using teach mode technology, associated with the availability of the flattest and most compact sensors on the market, ensures full integration in the machine and limits the risks of mechanical damage,
 - mechanical adjustments no longer necessary due to teach mode.
- Lower costs due to:
 - the elimination of adjustment times and complex supports
 - the elimination of flush mountable and non flush mountable versions, which halves the number of references,
 - much easier and much quicker product selection.

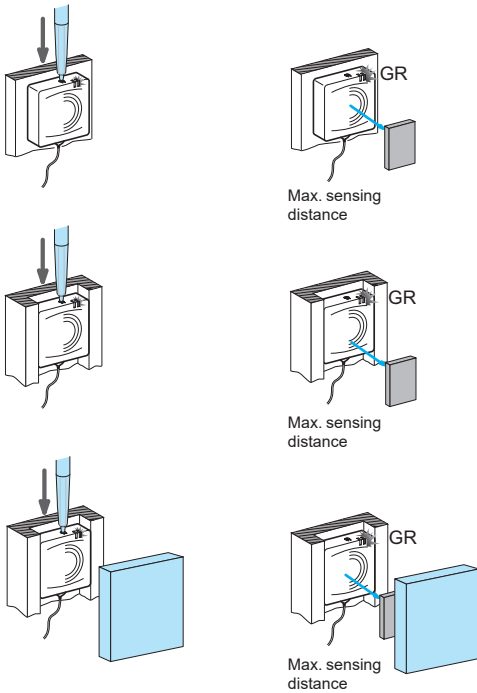

Precision position detection

All flush mountable inductive proximity sensors using teach mode benefit from ultra precise adjustment, which is very quick irrespective of the metal environment.

■ Precision side approach detection makes it possible to accurately define the distance at which the object will be detected as it passes the sensor. On the flush mountable sensors using teach mode, the desired detection position can be stored in memory by simply pressing the teach button.

■ Precision frontal approach detection makes it possible to accurately define the distance at which the object will be detected as it approaches the sensor. On the flush mountable sensors using teach mode, the desired detection position can be stored in memory by simply pressing the teach button.

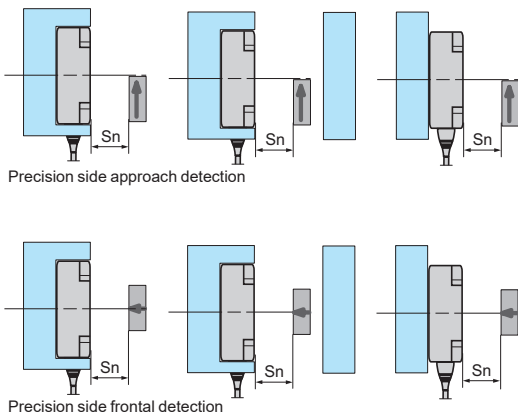

Mounting accessories

Telemecanique Sensors offers a complete, inexpensive range of mounting accessories (clamps, plates, brackets, etc.) that provide solutions for all installation problems.

- Fixing kits for quick installation or replacement of sensors
- No adjustment required. Simple clipping-in enables the sensor to be fixed in position and ready for operation.

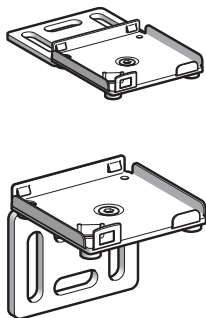

Inductive proximity sensors

XS range

Flush mountability using teach mode:
simplicity through innovation



Cylindrical type

Dimensions (mm)		12	18	30
Sensing distance (mm)	Flush mounted use	0...3.4	0...6	0...11
	Non flush mounted use	0...5	0...9	0...18
Sensor type		XS612B2	XS618B2	XS630B2
Page		72		



Block type

Dimensions (mm)		26 x 26 x 13	40 x 40 x 15	80 x 80 x 26
Sensing distance (mm)	Flush mounted use	0...10	0...15	0...40
	Non flush mounted use	0...15	0...25	0...60
Sensor type		XS8E1A1	XS8C1A1	XS8D1A1
Page		74		

Inductive proximity sensors

XS range, Application

Adjustable range sensors

Cylindrical, flush mountable using teach mode (1)

Three-wire DC, solid-state output

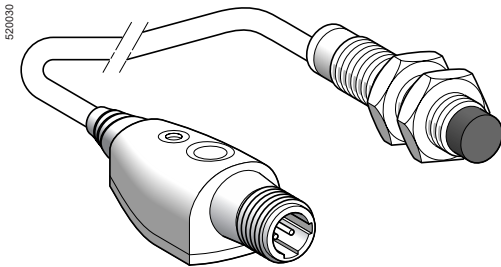

XS6●●B2●●L01M12

Ø 12, threaded M12 x 1

Sensing distance (Sn) mm	Function	Output	Connection	Reference	Weight kg
5	NO	PNP	Remote M12 connector on 0.15 m flying lead	XS612B2PAL01M12	0.100
		NPN	Remote M12 connector on 0.15 m flying lead	XS612B2NAL01M12	0.100
	NC	PNP	Remote M12 connector on 0.15 m flying lead	XS612B2PBL01M12	0.100
		NPN	Remote M12 connector on 0.15 m flying lead	XS612B2NBL01M12	0.100

Ø 18, threaded M18 x 1

Sensing distance (Sn) mm	Function	Output	Connection	Reference	Weight kg
9	NO	PNP	Remote M12 connector on 0.15 m flying lead	XS618B2PAL01M12	0.140
		NPN	Remote M12 connector on 0.15 m flying lead	XS618B2NAL01M12	0.140
	NC	PNP	Remote M12 connector on 0.15 m flying lead	XS618B2PBL01M12	0.140
		NPN	Remote M12 connector on 0.15 m flying lead	XS618B2NBL01M12	0.140

Ø 30, threaded M30 x 1.5

Sensing distance (Sn) mm	Function	Output	Connection	Reference	Weight kg
18	NO	PNP	Remote M12 connector on 0.15 m flying lead	XS630B2PAL01M12	0.220
		NPN	Remote M12 connector on 0.15 m flying lead	XS630B2NAL01M12	0.220
	NC	PNP	Remote M12 connector on 0.15 m flying lead	XS630B2PBL01M12	0.220
		NPN	Remote M12 connector on 0.15 m flying lead	XS630B2NBL01M12	0.220

Accessories (2)

Description	Reference	Weight kg
Remote control fixing clamp	XSZBPM12	0.015
Sensor fixing clamps	Ø 12	XSZB112 0.006
	Ø 18	XSZB118 0.010
	Ø 30	XSZB130 0.020

(1) For further information on flush or non flush mountable sensors using teach mode, see page 70.

(2) For further information, see page 118.

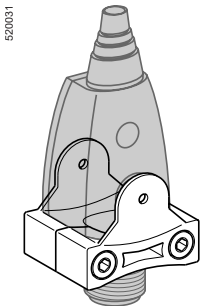

XSZBPM12

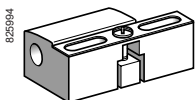

XSZB●●●

Inductive proximity sensors

XS range, Application

Adjustable range sensors

Cylindrical, flush mountable using teach mode

Three-wire DC, solid-state output

Characteristics		XS6●●B2●●L01M12	
Sensor type		UL, CSA, CE	
Product certifications		Remote M12 connector on 0.15 m flying lead	
Connection	Connector	Remote M12 connector on 0.15 m flying lead	
Sensing distance and adjustment zone	Ø 12	Nominal sensing distance (Sn)	mm 0...5 non flush mounted / 0...3.4 flush mounted
		Precision adjustment zone	mm 1.7...5 non flush mounted / 1.7...3.4 flush mounted
	Ø 18	Nominal sensing distance (Sn)	mm 0...9 non flush mounted / 0...6 flush mounted
		Precision adjustment zone	mm 3...9 non flush mounted / 3...6 flush mounted
	Ø 30	Nominal sensing distance (Sn)	mm 0...18 non flush mounted / 0...11 flush mounted
		Precision adjustment zone	mm 6...18 non flush mounted / 6...11 flush mounted
Differential travel		%	
Degree of protection		Conforming to IEC 60529 IP 67, \square	
Storage temperature		°C - 40...+ 85	
Operating temperature		°C - 25...+ 70	
Materials	Case	Nickel plated brass	
	Remote control	PBT	
	Cable	PvR - Ø 4.2 mm	
Vibration resistance		Conforming to IEC 60068-2-6 25 gn, amplitude ± 2 mm (f = 10 to 55 Hz)	
Shock resistance		Conforming to IEC 60068-2-27 50 gn, duration 11 ms	
Indicators	Output state	Yellow LED	
	Supply on and teach mode	Green LED	
Rated supply voltage		V --- 12...24 with protection against reverse polarity	
Voltage limits (including ripple)		V --- 10...36	
Switching capacity		mA ≤ 100 with overload and short-circuit protection	
Voltage drop, closed state		V ≤ 2	
Current consumption, no-load		mA ≤ 10	
Maximum switching frequency		Hz 1000	
Delays	First-up	ms ≤ 10	
	Response	ms ≤ 0.3	
	Recovery	ms ≤ 0.7	

Wiring schemes

Connector
M12

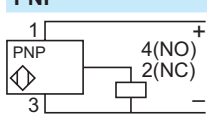
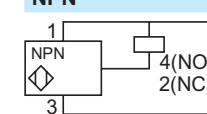

PNP	NPN
	

Setting-up

Minimum mounting distances (mm)

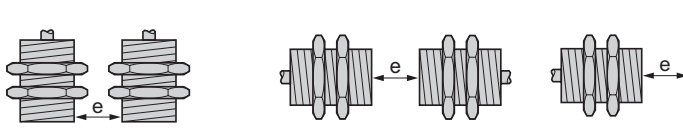

	Side by side		Face to face		Facing a metal object
	flush mounted	not flush mounted	flush mounted	not flush mounted	
Ø 12	e ≥ 14	50	e ≥ 50	100	e ≥ 3.4
Ø 18	e ≥ 28	100	e ≥ 100	200	e ≥ 6
Ø 30	e ≥ 48	180	e ≥ 180	360	e ≥ 11

Dimensions

XS6

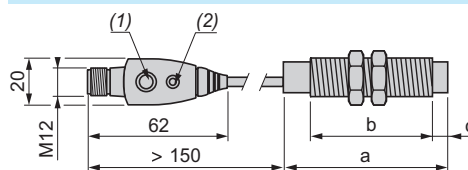

(1) Teach mode button
(2) LED

Connector (mm)

	a	b	c
Ø 12	59	42	5
Ø 18	64	44	8
Ø 30	62.6	41	13



Inductive proximity sensors

XS range, general purpose with increased range
 Flat, flush mountable using teach mode (1)
 Two-wire AC or DC
 Three-wire DC, solid-state output

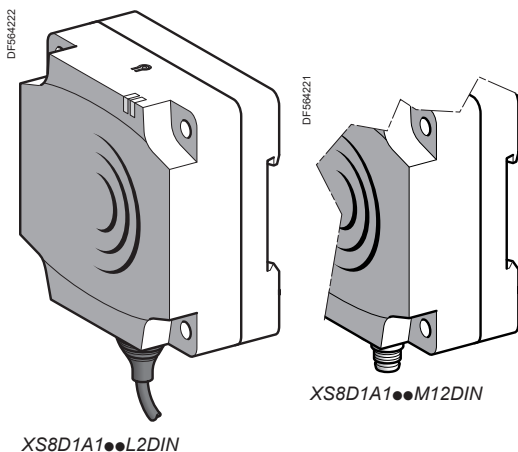
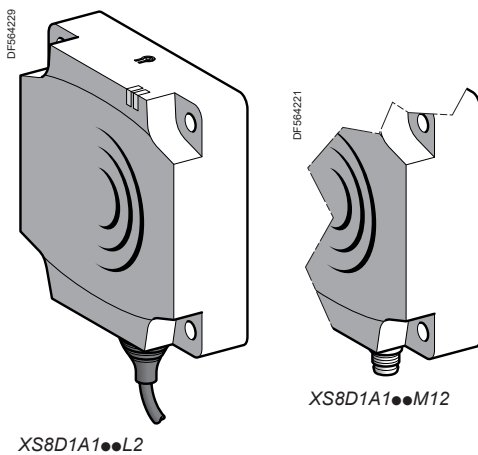
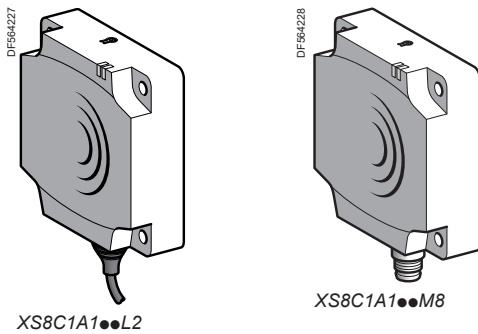
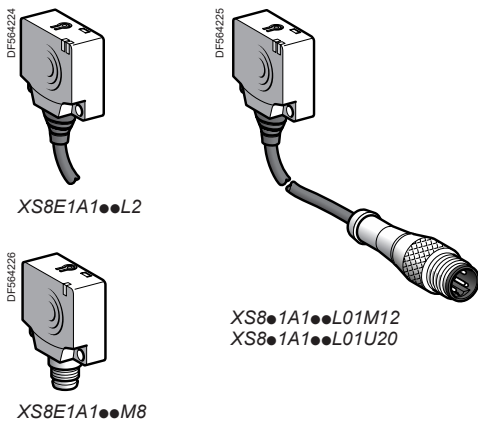

Flat, 26 x 26 x 13 mm format (2)

Sensing distance (Sn) mm	Function	Output	Connection	Reference	Weight kg
Three-wire --- with overload and short-circuit protection					
15	NO	PNP	Pre-cabled (L = 2 m) (3)	XS8E1A1PAL2	0.075
			M8 connector	XS8E1A1PAM8	0.040
			Remote M12 connector	XS8E1A1PAL01M12	0.040
	NPN	Pre-cabled (L = 2 m) (3)	XS8E1A1NAL2	0.075	
		M8 connector	XS8E1A1NAM8	0.040	
		Remote M12 connector	XS8E1A1NAL01M12	0.040	
NC	PNP	Pre-cabled (L = 2 m) (3)	XS8E1A1PBL2	0.075	
		M8 connector	XS8E1A1PBM8	0.040	
		Remote M12 connector	XS8E1A1PBL01M12	0.040	
	NPN	Pre-cabled (L = 2 m) (3)	XS8E1A1NBL2	0.075	
		M8 connector	XS8E1A1NBM8	0.040	
		Remote M12 connector	XS8E1A1NBL01M12	0.040	

Two-wire ~ or --- unprotected (4)

15	NO	-	Pre-cabled (L = 2 m) (3)	XS8E1A1MAL2	0.070
			Remote 1/2"-20UNF connector	XS8E1A1MAL01U20	0.040
	NC	-	Pre-cabled (L = 2 m) (3)	XS8E1A1MBL2	0.070
			Remote 1/2"-20UNF connector	XS8E1A1MBL01U20	0.040

Flat, 40 x 40 x 15 mm format (2)

Sensing distance (Sn) mm	Function	Output	Connection	Reference	Weight kg
Three-wire --- with overload and short-circuit protection					
25	NO	PNP	Pre-cabled (L = 2 m) (3)	XS8C1A1PAL2	0.095
			M8 connector	XS8C1A1PAM8	0.060
			Remote M12 connector	XS8C1A1PAL01M12	0.060
		NPN	Pre-cabled (L = 2 m) (3)	XS8C1A1NAL2	0.095
			M8 connector	XS8C1A1NAM8	0.060
			Remote M12 connector	XS8C1A1NAL01M12	0.060
	NC	PNP	Pre-cabled (L = 2 m) (3)	XS8C1A1PBL2	0.095
			M8 connector	XS8C1A1PBM8	0.060
			Remote M12 connector	XS8C1A1PBL01M12	0.060
		NPN	Pre-cabled (L = 2 m) (3)	XS8C1A1NBL2	0.095
			M8 connector	XS8C1A1NBM8	0.060
			Remote M12 connector	XS8C1A1NBL01M12	0.060

Two-wire ~ or --- unprotected (4)

25	NO	-	Pre-cabled (L = 2 m) (3)	XS8C1A1MAL2	0.090
			Remote 1/2"-20UNF connector	XS8C1A1MAL01U20	0.060
	NC	-	Pre-cabled (L = 2 m) (3)	XS8C1A1MBL2	0.090
			Remote 1/2"-20UNF connector	XS8C1A1MBL01U20	0.060

Flat, 80 x 80 x 26 mm format (2)

Sensing distance (Sn) mm	Function	Output	Connection	Reference	Weight kg
Three-wire --- with overload and short-circuit protection					
60	NO	PNP	Pre-cabled (L = 2 m) (3)	XS8D1A1PAL2 (5)	0.390
			M12 connector	XS8D1A1PAM12 (5)	0.340
			M12 connector	XS8D1A1PAL01M12 (5)	0.340
		NPN	Pre-cabled (L = 2 m) (3)	XS8D1A1NAL2 (5)	0.390
			M12 connector	XS8D1A1NAM12 (5)	0.340
			M12 connector	XS8D1A1NAL01M12 (5)	0.340
	NC	PNP	Pre-cabled (L = 2 m) (3)	XS8D1A1PBL2 (5)	0.390
			M12 connector	XS8D1A1PBM12 (5)	0.340
			M12 connector	XS8D1A1PBL01M12 (5)	0.340
		NPN	Pre-cabled (L = 2 m) (3)	XS8D1A1NBL2 (5)	0.390
			M12 connector	XS8D1A1NBM12 (5)	0.340
			M12 connector	XS8D1A1NBL01M12 (5)	0.340

Two-wire ~ or --- unprotected (4)

60	NO	-	Pre-cabled (L = 2 m) (3)	XS8D1A1MAL2 (5)	0.390
			1/2"-20UNF connector	XS8D1A1MAU20 (5)	0.340
			1/2"-20UNF connector	XS8D1A1MBU20 (5)	0.340
	NC	-	Pre-cabled (L = 2 m) (3)	XS8D1A1MBL2 (5)	0.390
			1/2"-20UNF connector	XS8D1A1MBL01U20 (5)	0.340
			1/2"-20UNF connector	XS8D1A1MBU20 (5)	0.340

(1) For further information on flush or non flush mountable sensors using teach mode, see page 70.

(2) For accessories, see page 118.

(3) For a 5 m long cable replace L2 by L5; for a 10 m long cable replace L2 by L10.

(4) It is essential to connect a 0.4 A "quick-blow" fuse in series with the load.

(5) For clipping onto 35 mm omega rail or 80 x 80 x 40 mm format, add DIN to the end of the reference. Example: **XS8D1A1PAL2 DIN**.

Characteristics		XS8E●●●●M8, XS8C●●●●M8, XS8D●●●●M12, XS8D●●●●U20	XS8E●●●●L01M12, XS8E●●●●L01U20, XS8C●●●●L01M12, XS8C●●●●L01U20	XS8E●●●●L2, XS8C●●●●L2, XS8D●●●●L2
Sensor type				
Product certifications		UL, CSA, CE, ECOLAB		
Connection	Connector	M8 except XS8●●●●M12: M12 XS8●●●●U20: 1/2"-20UNF	Remote on 0.15 m flying lead XS8●●●●L01M12: M12 XS8●●●●L01U20: 1/2"-20UNF	–
	Pre-cabled	–	–	Length: 2 m
Sensing distance and adjustment zone	XS8E	Nominal sensing dist. Sn	mm 0...15 not flush mounted / 0...10 flush mounted	
		Fine adjustment zone	mm 5...15 not flush mounted / 5...10 flush mounted	
	XS8C	Nominal sensing dist. Sn	mm 0...25 not flush mounted / 0...15 flush mounted	
		Fine adjustment zone	mm 8...25 not flush mounted / 8...15 flush mounted	
	XS8D	Nominal sensing dist. Sn	mm 0...60 not flush mounted / 0...40 flush mounted	
		Fine adjustment zone	mm 20...60 not flush mounted / 20...40 flush mounted	
Differential travel		% 1...15 of effective sensing distance (Sr)		
Degree of protection	Conforming to IEC 60529	IP 67, double insulation □ (except M8 connector: IP 67)		IP 68, □
Storage temperature		°C -40...+85		
Operating temperature		°C -25...+70		
Materials	Case	PBT		
	Cable	–	PvR 3 x 0.34 mm ² ≡ and PvR 2 x 0.34 mm ² ≡	
Vibration resistance	Conforming to IEC 60068-2-6	25 gn, amplitude ± 2 mm (f = 10 to 55 Hz)		
Shock resistance	Conforming to IEC 60068-2-27	50 gn, duration 11 ms		
Indicators	Output state	Yellow LED		
	Supply on and teach mode	Green LED		
Rated supply voltage	3-wire	V 12...24 with protection against reverse polarity		
	2-wire	V ~ or ≡ 24...240 (~ 50/60 Hz)		
Voltage limits (including ripple)	3-wire	V 10...36		
	2-wire	V ~ or ≡ 20...264		
Current consumption, no-load	3-wire	mA ≤ 10		
Residual current, open state	2-wire	mA ≤ 1.5		
Switching capacity	3-wire	mA ≤ 100 XS8E, ≤ 200 XS8C and XS8D, with overload and short-circuit protection		
	2-wire	mA 5...200 ≡ XS8E, 5...300 ~ XS8C and XS8D, 5...200 ≡ XS8C and XS8D		
Voltage drop, closed state	3-wire	V ≤ 2		
	2-wire	V ≤ 5.5		
Maximum switching frequency		Hz 2000 XS8E, 1000 XS8C, 150 XS8D		
Delays	First-up	ms ≤ 10 XS8E, XS8C and XS8D (3-wire), ≤ 10 XS8E and XS8C, ≤ 15 XS8D (2-wire)		
	Response	ms ≤ 0.3		
	Recovery	ms ≤ 0.8 XS8E and XS8C, ≤ 6 XS8D		

Wiring schemes

Connector	Pre-cabled	PNP/M12 or M8	NPN/M12 or M8	2-wire 1/2"-20UNF
<p>M8 M12 1/2"-20UNF</p>	<p>BU: Blue BN: Brown BK: Black</p>			

For M8 connector, NO and NC outputs on terminal 4

Setting-up

Minimum mounting distances (mm)				
Side by side	$e \geq$	XS8E	XS8C	XS8D
	Flush mounted	40	60	200
	Not flush mounted	150	125	600
Face to face	$e \geq$	XS8E	XS8C	XS8D
	Flush mounted	80	120	400
	Not flush mounted	300	250	not recommended
Facing a metal object	$e \geq$	XS8E	XS8C	XS8D
		10	15	40

Dimensions

XS8C/D/E	XS8C/D	XS8E							
		(1) LED (2) Teach mode button (3) For CHC type screws							
Sensor	A (cable)	A (connector)	B	C	D	E	F	G	H
XS8E	14	11	26	13	8.8	20	3.5	6.8	6.6
XS8C	14	11	40	15	9.8	33	4.5	8.3	13.6
XS8D	23	18	80	26	16	65	5.5	8.5	37.8
XS8D●●DIN	23	18	80	40	30	65	5.1	22.5	37.8

Inductive proximity sensors

XS range, Application

Sensors for rotation monitoring, slip detection, shaft overload detection

Cylindrical form

Example:
Coupling breakage monitoring

B2Z138

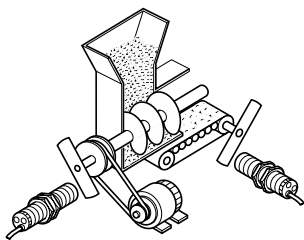

D1602242

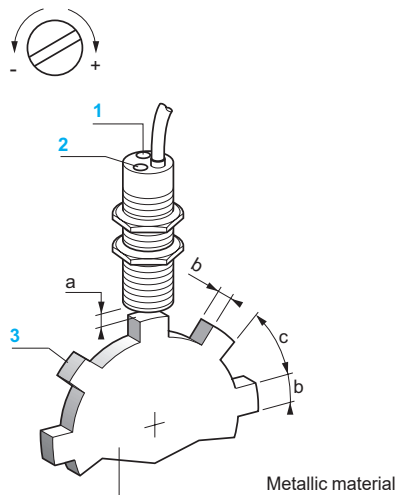

Functions

These self-contained rotation speed monitoring sensors have the special feature of incorporating, in the same case, the pulse sensing and processing electronics as well as the output switching amplifier that are required to establish an integrated rotation monitoring device.

The unit provides an economical solution for detecting slip, belt breakage, drive shaft shear and overloading, etc., in the following applications: conveyor belts, bucket elevators, Archimedian screws, grinders, crushers, pumps, centrifugal driers, mixers, etc.

Operating principle

The output signal of this type of sensor is processed by an impulse comparator incorporated in the sensor. The impulse frequency F_c generated by the moving part to be monitored is compared to the frequency F_r preset on the sensor. The output switching circuit of the sensor is in the closed state for $F_c > F_r$ and the open state for $F_c < F_r$.

Sensors XSAV are particularly suitable for the detection of underspeed: when the speed of the moving part F_c falls below a preset threshold F_r , this causes the output circuit of the sensor to switch off.

Note: Following power-up, the operational status of the sensor is subject to a delay of 9 seconds in order for the moving part being monitored to run-up to its nominal speed. During this time, the output of the sensor remains in the closed state.

Adjustment of frequency threshold

- Adjustment of sensor's frequency threshold: using potentiometer, 15 turns approximately.
- To increase the frequency threshold: turn the adjustment screw clockwise (+).
- To decrease the frequency threshold: turn the adjustment screw anti-clockwise (-).

1: Potentiometer	Diameter of sensor		
2: LED	a	b	c
3: Metal target	M30	4...6 mm	30 mm 60 mm

Potentiometer adjustment curves (for XSAV1●801, 2-wire ~ or --- sensors)

Low speed version (6...150 impulses/minute) High speed version (120...3000 impulses/minute)

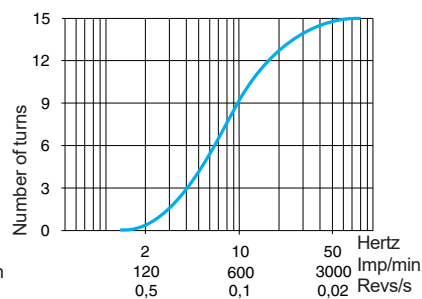
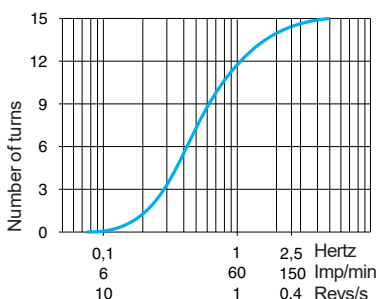

Setting-up

Minimum distances (mm)

Side by side

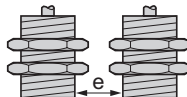

$e \geq 20$

Facing a metal object

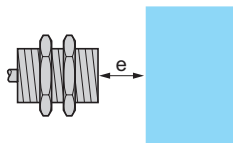

$e \geq 30$

Face to face

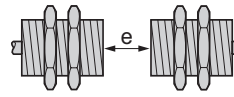

$e \geq 120$

Mounted in a metal support

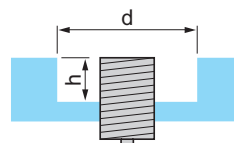

$d \geq 30, h \geq 0$

Fixing nut tightening torque: $< 50 \text{ N.m} / 442.53 \text{ lb-in}$

Flush mountable in metal

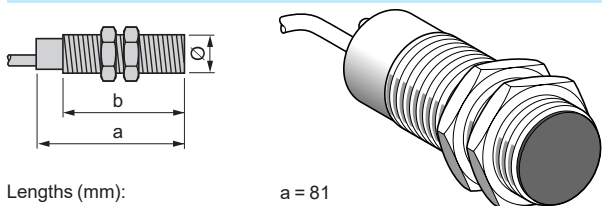

Lengths (mm):

a = Overall

b = Threaded section

a = 81

b = 67

Ø = M30

	DC	DC	AC/DC	AC/DC
Nominal sensing distance (Sn)	10 mm	10 mm	10 mm	10 mm
Adjustable frequency range	6...150 impulses/min	120...3000 impulses/min	6...150 impulses/min	120...3000 impulses/min

References

3-wire $\overline{\text{---}}$	PNP / NC	XSAV11373	XSAV12373	–	–
2-wire $\overline{\text{---}}$ or \sim / NC	–	–	–	XSAV11801	XSAV12801
Weight (kg)	0.300				

Characteristics

Connection	Pre-cabled, 3 x 0.34 mm ² , length 2 m (1)	Pre-cabled, 2 x 0.34 mm ² , length 2 m (1)
Degree of protection conforming to IEC 60529	IP 67	
Operating zone	0...8 mm	
Repeat accuracy	3 % of Sr	
Differential travel	3...15 % of Fr	
Operating temperature	-25...+70 °C	
Output state indication	Red LED	
Rated supply voltage	$\overline{\text{---}}$ 12...48 V with protection against reverse polarity	\sim 24...240 V (50/60 Hz) or $\overline{\text{---}}$ 24...210 V
Voltage limits (including ripple)	$\overline{\text{---}}$ 10...58 V	\sim or $\overline{\text{---}}$ 20...264 V
Switching capacity	≤ 200 mA with overload and short-circuit protection	\sim 5...350 mA or $\overline{\text{---}}$ 5...200 mA (2)
Voltage drop, closed state	≤ 1.8 V	≤ 5.7 V
Residual current, open state	–	≤ 1.5 mA
Current consumption, no-load	≤ 15 mA	–
Maximum switching frequency	6000 impulses/min (for XSAV11●●●); 48,000 impulses/min (for XSAV12●●●)	
“Run-up” delay following power-up	9 seconds ± 20 % + 1/Fr (3)	

Wiring schemes

3-wire $\overline{\text{---}}$
XSAV1●373

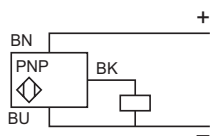

2-wire \sim or $\overline{\text{---}}$
XSAV1●801

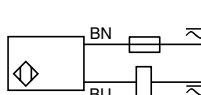

(1) For a 5 m long cable add L05 to the reference, for a 10 m long cable add L10 to the reference.

Example: XSAV11373 becomes XSAV11373L05 with a 5 m long cable.

(2) These sensors do not incorporate overload or short-circuit protection and therefore, it is essential to connect a 0.4 A “quick-blow” fuse in series with the load, see page 118.

(3) For a sensor without a “run-up” delay following power-up, replace XSAV1 in the reference by XSAV0. Example: XSAV11801 becomes XSAV01801 without a “run-up” delay. For a reduced “run-up” delay of 3 s, replace XSAV1 in the reference by XSAV3.

Inductive proximity sensors

XS range, Application

Sensors for rotation monitoring, slip detection and shaft overload detection, with teach mode

Operating principle and applications

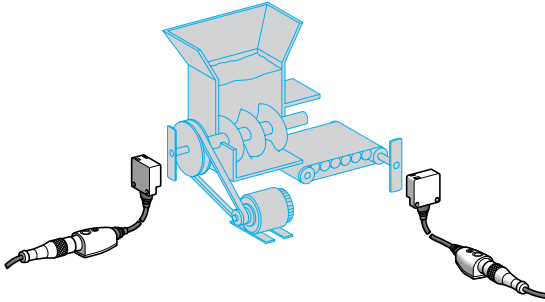

- These inductive proximity sensors are designed for monitoring rotational speed or the speed of the flow of objects to be protected or monitored. They operate on the principle of comparing a speed threshold preset by the operator against the instantaneous measurement of the speed of the moving object to be protected.
- They provide a simple, economical solution for detecting slip, belt breakage, coupling breakage and overload, etc.
- They are widely used in grinder/crusher, mixer, pump, centrifugal driver, conveyor belt, bucket elevator, Archimedeian screw, etc. type applications.

Installation and setting-up

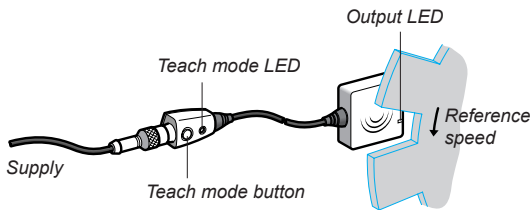

Setting-up and positioning the sensor

- In the positioning phase, the XS9 sensor can operate as a standard inductive sensor (Schneider Electric patent). Operation in inductive mode enables validation of reliable detection of all the moving objects to be monitored.
- Using this system, the positioning is therefore made 100 % reliable and can be checked at any time without altering the settings of the sensor.

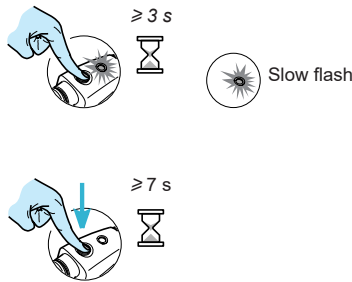

Speed adjustment in teach mode

- The normal or reference speed of the moving object (1) to be monitored is adjusted by simply pressing the teach mode button (2) and is then validated by the display LED.
- If in doubt, the sensor can be reset at any time to the factory settings.
- (1) To allow the moving object to reach its normal speed (machine inertia), the sensor holds its output closed for 9 seconds.
- (2) The sensor's default drop-out underspeed corresponds to the preset speed - 30 %.
Example: If the preset speed is 1000 rpm, the sensor drops out on underspeed when the speed of the moving object drops below $1000 - (1000 \times 0.3) = 700$ rpm.
- 20 %, - 11 % and - 6 % thresholds can be obtained by pressing the teach mode button.

Setting-up

Minimum mounting distances (mm)

Type	Side by side	Face to face
XS9E	$e \geq 40$	$e \geq 80$
XS9C	$e \geq 60$	$e \geq 120$

Dimensions

XS9E, XS9C

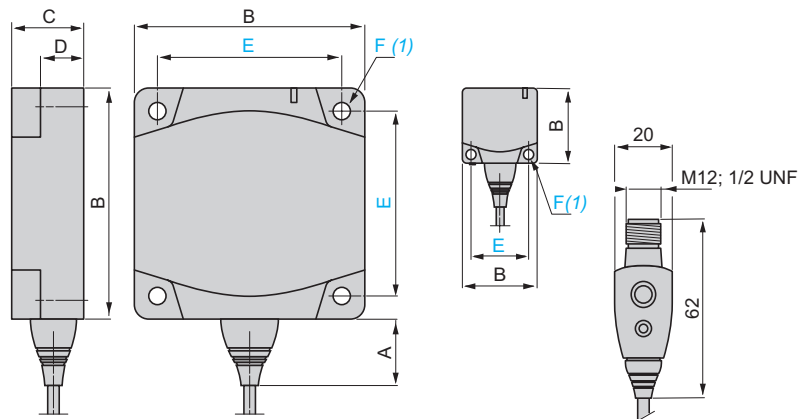

(1) For CHC type screws

Type	A	B	C	D	E	F
XS9E	14	26	13	8.8	20	3.5
XS9C	14	40	15	9.8	33	4.5

Inductive proximity sensors

XS range, Application

Sensors for rotation monitoring, slip detection and shaft overload detection, with teach mode

Flush mountable in metal

PBT case

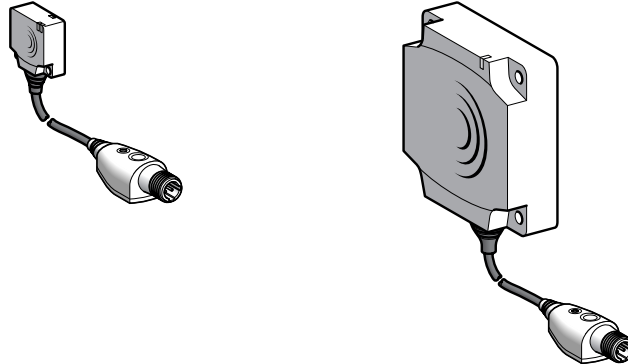

Nominal sensing distance (Sn)	10 mm	15 mm	10 mm	15 mm
Adjustable frequency range	6...6000 impulses/min			

References

3-wire	PNP / NC	XS9E11RPBL01M12	XS9C11RPBL01M12	–	–
2-wire	~ or ~ / NC	–	–	XS9E11RMBL01U20	XS9C11RMBL01U20
Weight (kg)		0.040	0.060	0.040	0.060

Characteristics

Product certifications	UL, CSA, CE			
Connection	Remote M12 connector on 0.15 m flying lead		Remote 1/2"-20UNF connector on 0.15 m flying lead	
Operating zone	0...8 mm	0...12 mm	0...8 mm	0...12 mm
Degree of protection	Conforming to IEC 60529 IP 67, double insulation			
Storage temperature	- 40...+ 85 °C			
Operating temperature	- 25...+ 70 °C			
Vibration resistance	Conforming to IEC 60068-2-6 25 gn, amplitude ± 2 mm (f = 10 to 55 Hz)			
Shock resistance	Conforming to IEC 60068-2-27 50 gn, duration 11 ms			
Indicators	Output state Supply on			
Rated supply voltage	~ 12...24 V		~ or ~ 24...240 V (50/60 Hz)	
Voltage limits (including ripple)	~ 10...36 V		~ or ~ 20...264 V	
Switching capacity	≤ 100 mA (1)	≤ 200 mA (1)	~ or ~ 5...100 mA (2)	~ 5...200 mA, ~ 5...300 mA(2)
Voltage drop, closed state	≤ 2 V		≤ 5.5 V	
Residual current, open state	≤ 100 mA		≤ 1.5 mA	
Current consumption, no-load	≤ 10 mA		–	
Maximum switching frequency	48,000 impulses/min			
"Run-up" delay following power-up	9 seconds + 1/Fr			

(1) With overload and short-circuit protection.

(2) It is essential to connect a 0.4 A "quick-blow" fuse in series with the load.

Wiring schemes

Connector		3-wire ~	2-wire ~ or ~
M12	1/2"-20UNF	XS9E11RPBL01M12	XS9E11RMBL01U20

Accessory (1)

Description	Reference	Weight kg
Remote control fixing clamp	XSZBPM12	0.015

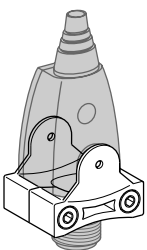

XSZBPM12

(1) For accessories, see page 118.

Inductive proximity sensors

XS range, Application

Sensors with analogue output signal 0...10 V ⁽¹⁾

or 4...20 mA

For position, displacement and deformation control/monitoring

Functions

Example:
Sorting parts

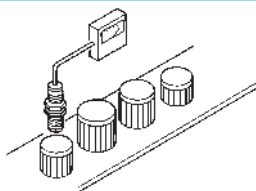

These analogue output proximity sensors are solid-state sensors designed for monitoring displacement. They are not measuring sensors. They are suitable for use in many sectors, particularly for applications involving:

- deformation and displacement monitoring,
- vibration amplitude and frequency monitoring,
- control of dimensional tolerances,
- position control,
- concentricity or eccentricity monitoring.

Operating principle

The operating principle of the sensor is that of a damped oscillator. The degree of damping will depend on the distance of an object from the sensing face. The sensor will sense the distance and produce an output current with a value directly proportional to this distance.

Output curves 4..0.20 mA, 2-wire connection

XS1M12AB120

Sn = 0.2...2 mm

Ø 12 mm

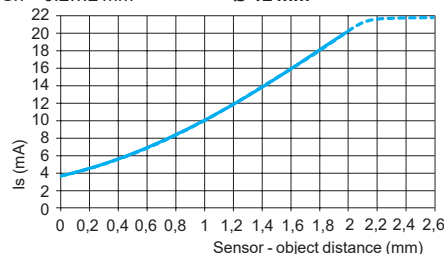

XS1M18AB120

Sn = 0.5...5 mm

Ø 18 mm

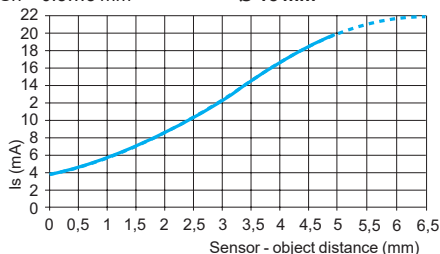

XS1M30AB120

Sn = 1...10 mm

Ø 30 mm

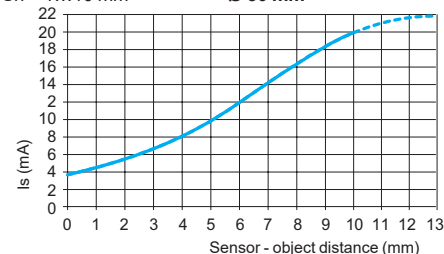

XS4P12AB120

Sn = 0.4...4 mm

Ø 12 mm

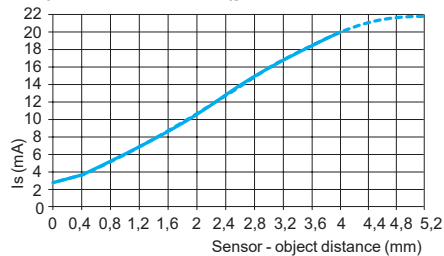

XS4P18AB120

Sn = 0.8...8 mm

Ø 18 mm

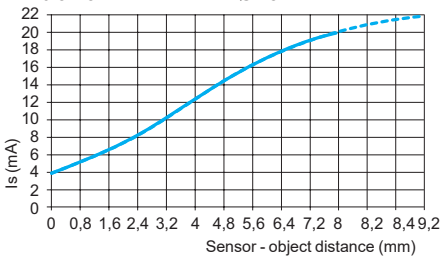

XS4P30AB120

Sn = 1.5...15 mm

Ø 30 mm

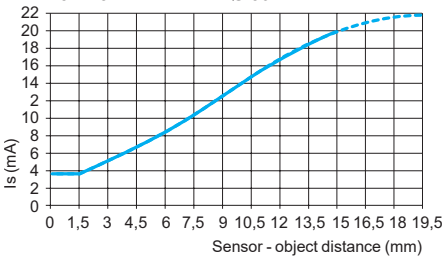

Output curves 0...10 V, 3-wire connection

XS4P12AB110

Sn = 0.4...4 mm

Ø 12 mm

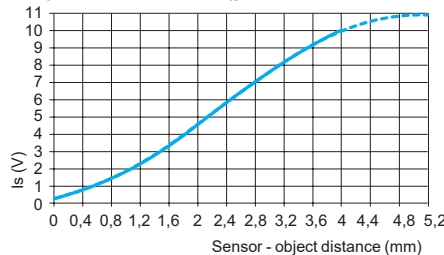

XS4P18AB110

Sn = 0.8...8 mm

Ø 18 mm

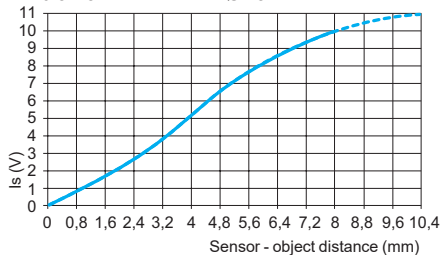

XS4P30AB110

Sn = 1.5...15 mm

Ø 30 mm

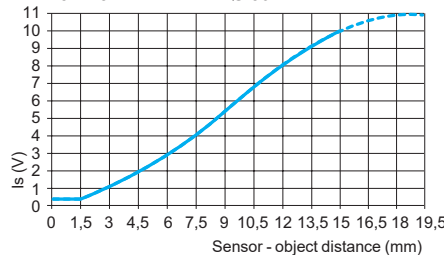

Wiring schemes

2-wire connection

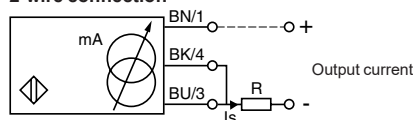

3-wire connection

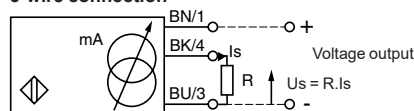

Output current	Load impedance value
12 V	4...20 mA
24 V	4...20 mA
	$R \leq 8.2 \Omega$
	$R \leq 470 \Omega$

Ensure a minimum of 10 V between the + and the - (terminal 3) of the sensor.

Output current	Load impedance value	Output voltage	Load impedance value
24 V	0...10 mA	0...10 V	$R = 1000 \Omega$
48 V	0...10 mA	0...10 V	$R = 1000 \Omega$

Ensure a minimum of 5 V between the + and the sensor output (terminal 4).

⁽¹⁾ Voltage range only obtained with a load impedance of 1000 Ω .

Inductive proximity sensors

XS range, Application

Sensors with analogue output signal 0...10 V ⁽¹⁾

or 4...20 mA

For position, displacement and deformation control/monitoring

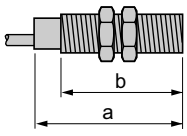
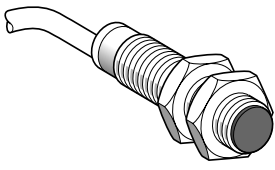
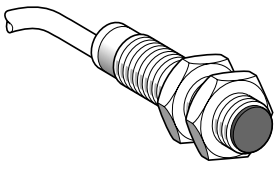
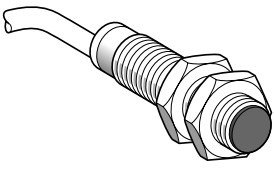
Sensor	Flush mountable in metal	Non flush mountable in metal	
			
Lengths (mm): a = Overall b = Threaded section	a = 50 b = 42	a = 50 b = 42	a = 54 b = 42
Nominal sensing distance (Sn)	Metal case 2 mm	Plastic case 4 mm	Plastic case 4 mm

References			
3-wire ---	Output 0...10 V (2)	–	–
2-wire ---	Output 4...20 mA (2)	XS1M12AB120	XS4P12AB120
Weight (kg)		0.075	0.065
			XS4P12AB110

Characteristics			
Product certifications	CE, UL, CSA		
Connection	Pre-cabled, PvR 3 x 0.34 mm ² , length 2 m		
Degree of protection Conforming to IEC 60529	IP 67		
Operating zone	0.2...2 mm	0.4...4 mm	0.4...4 mm
Repeat accuracy	± 3 %		
Linearity error	± 2 mA		± 1 V
Ambient air temperature	For operation: - 25...+ 70 °C		
Rated supply voltage	--- 12...24 V	--- 12...24 V	--- 24...48 V
Voltage limits (including ripple)	--- 10...36 V	--- 10...36 V	--- 15...58 V
Output current drift Ambient temperature: - 25...+ 70 °C	≤ 10 %		
Current consumption, no-load	4 mA		
Maximum operating rate	1500 Hz		

(1) Voltage range only obtained with a load impedance of 1000 Ω.

(2) Output current range Is, see page 80.

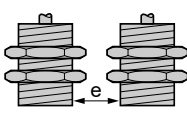
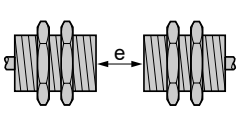
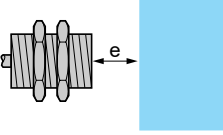
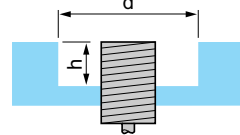
Setting-up				
Minimum mounting distances (mm)	Side by side	Face to face	Facing a metal object	Mounted in a metal support
				
XS1M12AB120 flush mountable	e ≥ 4	e ≥ 24	e ≥ 6	d ≥ 12, h ≥ 0
XS4P12AB110 non flush mountable	e ≥ 16	e ≥ 48	e ≥ 12	d ≥ 36, h ≥ 8
XS4P12AB120 non flush mountable	e ≥ 16	e ≥ 48	e ≥ 12	d ≥ 36, h ≥ 8
Fixing nut tightening torque	< 6 N.m (metal case), < 2 N.m (plastic case)			
Other versions	Please consult our Customer Care Centre.			

Inductive proximity sensors

XS range, Application

Sensors with analogue output signal 0...10 V ⁽¹⁾
or 4...20 mA

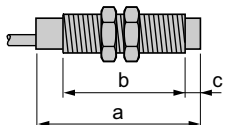
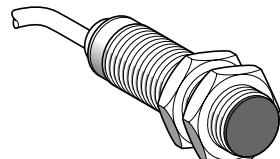
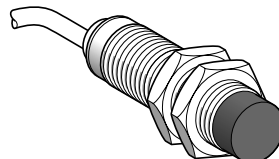
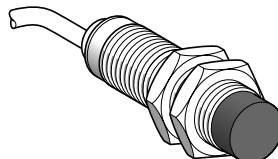
Sensor	Flush mountable in metal	Non flush mountable in metal	
			
Lengths (mm): a = Overall b = Threaded section c = For non flush mountable sensors	a = 53 b = 44 c = 0	a = 41 b = 26 c = 8	a = 41 b = 26 c = 8
Nominal sensing distance (S _n)	Metal case 5 mm	Plastic case 8 mm	Plastic case 8 mm

References			
3-wire $\overline{\text{---}}$ Output 0...10 V (2)	–	–	XS4P18AB110
2-wire $\overline{\text{---}}$ Output 4...20 mA (2)	XS1M18AB120	XS4P18AB120	–
Weight (kg)	0.120	0.080	0.080

Characteristics			
Product certifications	CE, UL, CSA		
Connection	Pre-cabled, PVR 3 x 0.34 mm ² , length 2 m		
Degree of protection Conforming to IEC 60529	IP 67		
Operating zone	0.5...5 mm	0.8...8 mm	0.8...8 mm
Repeat accuracy	± 3 %		
Linearity error	± 2 mA		± 1 V
Ambient air temperature	For operation: - 25...+ 70 °C		
Rated supply voltage	$\overline{\text{---}}$ 12...24 V	$\overline{\text{---}}$ 12...24 V	$\overline{\text{---}}$ 24...48 V
Voltage limits (including ripple)	$\overline{\text{---}}$ 10...36 V	$\overline{\text{---}}$ 10...36 V	$\overline{\text{---}}$ 15...58 V
Output current drift Ambient temperature: - 25...+ 70 °C	≤ 10 %		
Current consumption, no-load	4 mA		
Maximum operating rate	500 Hz		

(1) Voltage range only obtained with a load impedance of 1000 Ω.
(2) Output current range is, see page 80.

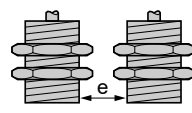
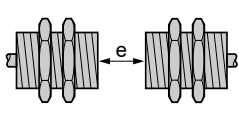
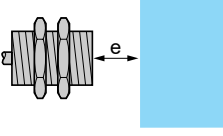
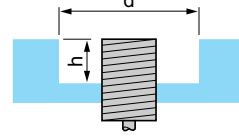
Setting-up				
Minimum mounting distances (mm)	Side by side	Face to face	Facing a metal object	Mounted in a metal support
				
XS1M18AB120 flush mountable	e ≥ 10	e ≥ 60	e ≥ 15	d ≥ 18, h ≥ 0
XS4P18AB110 non flush mountable	e ≥ 32	e ≥ 96	e ≥ 24	d ≥ 54, h ≥ 16
XS4P18AB120 non flush mountable	e ≥ 32	e ≥ 96	e ≥ 24	d ≥ 54, h ≥ 16

Fixing nut tightening torque	< 15 N.m (metal case), < 5 N.m (plastic case)
Other versions	Please consult our Customer Care Centre.

Inductive proximity sensors

XS range, Application

Sensors with analogue output signal 0...10 V ⁽¹⁾
or 4...20 mA

Sensor	Flush mountable in metal	Non flush mountable in metal	
Lengths (mm): a = Overall b = Threaded section c = For non flush mountable sensors	a = 50 b = 42 c = 0	a = 53 b = 32 c = 13	a = 53 b = 32 c = 13
Nominal sensing distance (Sn)	Metal case 10 mm	Plastic case 15 mm	Plastic case 15 mm

References			
3-wire ---	Output 0...10 V (2)	–	XS4P30AB110
2-wire ---	Output 4...20 mA (2)	XS1M30AB120	XS4P30AB120
Weight (kg)		0.200	0.100

Characteristics			
Product certifications	CE, UL, CSA		
Connection	Pre-cabled, PvR 3 x 0.34 mm ² , length 2 m		
Degree of protection Conforming to IEC 60529	IP 67		
Operating zone	1...10 mm	1.5...15 mm	1.5...15 mm
Repeat accuracy	± 3 %		
Linearity error	± 2 mA		± 1 V
Ambient air temperature	For operation: - 25...+ 70 °C		
Rated supply voltage	--- 12...24 V	--- 12...24 V	--- 24...48 V
Voltage limits (including ripple)	--- 10...36 V	--- 10...36 V	--- 15...58 V
Output current drift Ambient temperature: - 25...+ 70 °C	≤ 10 %		
Current consumption, no-load	4 mA		
Maximum operating rate	300 Hz		

(1) Voltage range only obtained with a load impedance of 1000 Ω.

(2) Output current range Is, see page 80.

Setting-up				
Minimum mounting distances (mm)	Side by side	Face to face	Facing a metal object	Mounted in a metal support
XS1M30AB120 flush mountable	e ≥ 20	e ≥ 120	e ≥ 30	d ≥ 30, h ≥ 0
XS4P30AB110 non flush mountable	e ≥ 60	e ≥ 180	e ≥ 45	d ≥ 90, h ≥ 30
XS4P30AB120 non flush mountable	e ≥ 60	e ≥ 180	e ≥ 45	d ≥ 90, h ≥ 30
Fixing nut tightening torque	< 40 N.m (metal case), < 20 N.m (plastic case)			
Other versions	Please consult our Customer Care Centre.			

Inductive proximity sensors

XS range, Application

Sensors with analogue output signal 0...10 V ⁽¹⁾

For position, displacement and deformation control/monitoring

Functions

These analogue output proximity sensors are solid-state sensors designed for monitoring displacement. They are not measuring sensors.

They are suitable for use in many sectors, particularly for applications involving:

- deformation and displacement monitoring,
- vibration amplitude and frequency monitoring,
- control of dimensional tolerances,
- position control,
- concentricity or eccentricity monitoring.

Operating principle

The operating principle of the sensor is that of a damped oscillator. The degree of damping will depend on the distance of an object from the sensing face. The sensor will sense the distance and produce an output current with a value directly proportional to this distance.

Output curves 0...10 V, 3-wire connection

XS9F

$S_n = 1...5$ mm

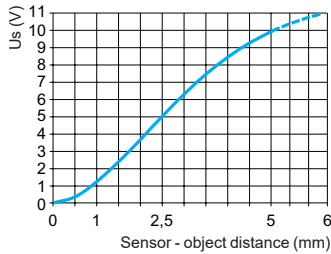

XS9E

$S_n = 1...10$ mm

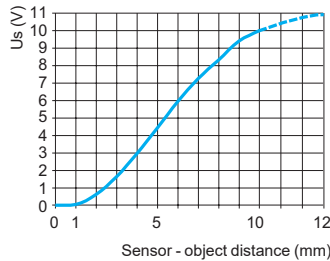

XS9C

$S_n = 2...15$ mm

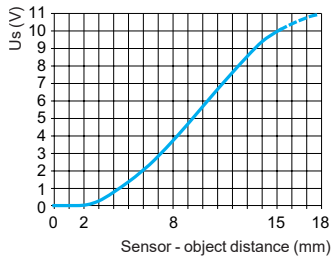

XS9D

$S_n = 5...40$ mm

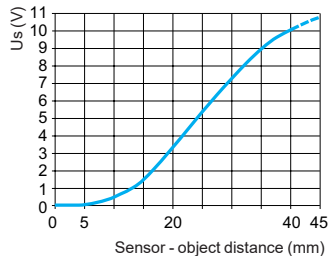

Wiring schemes

Connector



Pre-cabled

BN: Brown
BU: Blue
BK: Black

3-wire connection

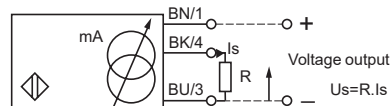

Output current	Load impedance value	Output voltage	Load impedance value
24 V	0...10 mA	$R \leq 1400 \Omega$	0...10 V
			$R = 1000 \Omega$

Note: Ensure a minimum of 5 V between the + (terminal 1) and the sensor output (terminal 4).

⁽¹⁾ Voltage range only obtained with a load impedance of 1000 Ω .

Inductive proximity sensors

XS range, Application

Sensors with analogue output signal 0...10 V (1)

For position, displacement and deformation control/monitoring

Flush mountable in metal



PBT case

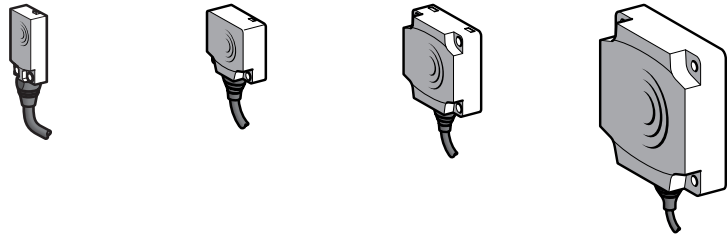

Nominal sensing distance (Sn)		5 mm	10 mm	15 mm	40 mm
References					
3-wire $\overline{\text{---}}$	Pre-cabled (L = 2 m) (2)	XS9F111A1L2	XS9E111A1L2	XS9C111A1L2	XS9D111A1L2
0...10 V	Connector	XS9F111A1L01M8	XS9E111A1L01M12	XS9C111A1L01M12	XS9D111A1M12
Weight (kg)	Pre-cabled (L = 2 m) (2)	0.060	0.075	0.095	0.340
	Connector	0.040	0.055	0.075	0.320

Characteristics					
Product certifications		UL, CSA, Cc	UL, CSA, Cc, ECOLAB		
Connection	Pre-cabled	PvR 3 x 0.34 mm ² , length 2 m for XS9●111A●L2			
	Connector	0.15 m flying lead with M8 connector	0.15 m flying lead with M12 connector		M12
Operating zone		1...5 mm	1...10 mm	2...15 mm	5...40 mm
Degree of protection Conforming to IEC 60529	Pre-cabled	IP 68	IP 68, double insulation \square		
	Connector	IP 67	IP 67, double insulation \square		
Storage temperature		- 40...+ 85 °C			
Operating temperature		- 25...+ 70 °C			
Materials		PBT case			
Vibration resistance	Conforming to IEC 60068-2-6	25 gn, amplitude \pm 2 mm (f = 10 to 55 Hz)			
Shock resistance	Conforming to IEC 60068-2-27	50 gn, duration 11 ms			
Output state indication		No			
Rated supply voltage		$\overline{\text{---}}$ 24 V			
Voltage limits (including ripple)		$\overline{\text{---}}$ 15...36 V			
Repeat accuracy		\pm 3 %			
Linearity error		\pm 1 V			
Current consumption, no-load		\leq 4 mA with overload and short-circuit protection			
Maximum operating frequency		2000 Hz	1000 Hz	100 Hz	
Output current drift		\leq 10 % (throughout the operating temperature range)			

Dimensions

XS9F	XS9E/C/D	XS9C/D	XS9E				
			(3) For CHC type screws				
Type	A (L2)	A (M12)	B	C	D	E	F
XS9E	14	—	26	13	8.8	20	3.5
XS9C	14	—	40	15	9.8	33	4.5
XS9D	23	14	80	26	16	65	5.5

Setting-up (Minimum mounting distances (mm))

Type	Side by side	Face to face	Facing a metal object
XS9F			
XS9E	$e \geq 15$	$e \geq 36$	$e \geq 15$
XS9C	$e \geq 30$	$e \geq 72$	$e \geq 30$
XS9D	$e \geq 45$	$e \geq 110$	$e \geq 45$
XS9D	$e \geq 120$	$e \geq 300$	$e \geq 120$

(1) Voltage range only obtained with a load impedance of 1000 Ω .
 (2) For a 5 m long cable replace L2 by L5, for a 10 m long cable replace L2 by L10.
 Example: XS9C111A1L2 becomes XS9C111A1L5 with a 5 m long cable.

Inductive proximity sensors

XS range, Application

Sensors with analogue output signal 4...20 mA

For position, displacement and deformation control/monitoring

Functions

These analogue output proximity sensors are solid-state sensors designed for monitoring displacement. They are not measuring sensors.

They are suitable for use in many sectors, particularly for applications involving:

- deformation and displacement monitoring,
- vibration amplitude and frequency monitoring,
- control of dimensional tolerances,
- position control,
- concentricity or eccentricity monitoring.

Operating principle

The operating principle of the sensor is that of a damped oscillator. The degree of damping will depend on the distance of an object from the sensing face. The sensor will sense the distance and produce an output current with a value directly proportional to this distance.

Output curves 4...20 mA, 2-wire connection

XS9F

Sn = 1...5 mm

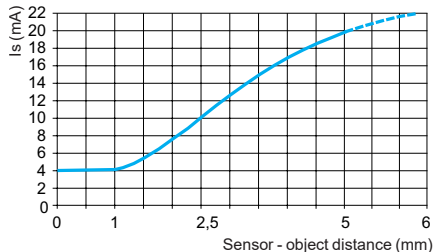

XS9E

Sn = 1...10 mm

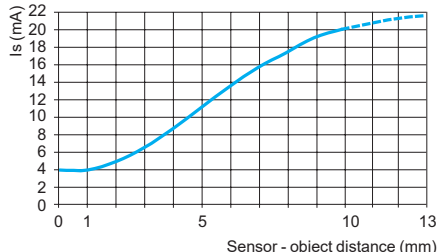

XS9C

Sn = 2...15 mm

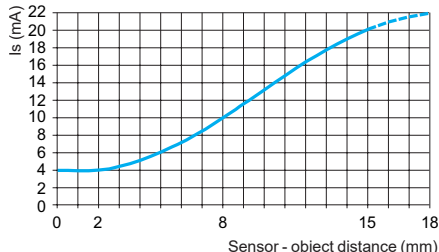

XS9D

Sn = 5...40 mm

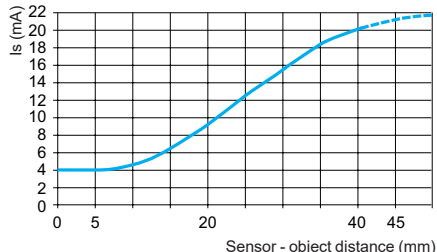

Wiring schemes

Connector



Pre-cabled

BN: Brown
BU: Blue
BK: Black

2-wire connection

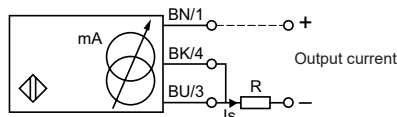

	Output current	Load impedance value
12 V	4...20 mA	$R \leq 8.2 \Omega$
24 V	4...20 mA	$R \leq 470 \Omega$

Note: Ensure a minimum of 10 V between the + (terminal 1) and - (terminal 3) of the sensor.

Inductive proximity sensors

XS range, Application

Sensors with analogue output signal 4...20 mA

For position, displacement and deformation control/monitoring

Flush mountable in metal



PBT case

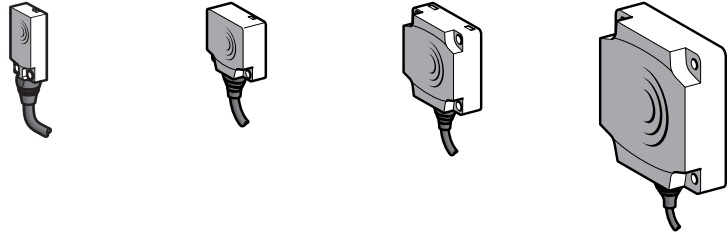

Nominal sensing distance (Sn)	5 mm	10 mm	15 mm	40 mm
-------------------------------	------	-------	-------	-------

References					
2-wire $\overline{\text{---}}$	Pre-cabled (L = 2 m) (1)	XS9F111A2L2	XS9E111A2L2	XS9C111A2L2	XS9D111A2L2
4...20 mA	Connector	XS9F111A2L01M8	XS9E111A2L01M12	XS9C111A2L01M12	XS9D111A2M12
Weight (kg)	Pre-cabled (L = 2 m)	0.060	0.075	0.095	0.340
	Connector	0.040	0.055	0.075	0.320

Characteristics					
Product certifications		UL, CSA, CE	UL, CSA, CE, ECOLAB		
Connection	Pre-cabled	PvR 3 x 0.34 mm ² , length 2 m for XS9●111A●L2			
	Connector	0.15 m flying lead with M8 connector	0.15 m flying lead with M12 connector		M12
Operating zone		1...5 mm	1...10 mm	2...15 mm	5...40 mm
Degree of protection	Pre-cabled	IP 68	IP 68, double insulation \square		
	Connector	IP 67	IP 67, double insulation \square		
Storage temperature		- 40...+ 85 °C			
Operating temperature		- 25...+ 60 °C		- 25...+ 70 °C	
Materials		PBT case			
Vibration resistance	Conforming to IEC 60068-2-6	25 gn, amplitude \pm 2 mm (f = 10 to 55 Hz)			
Shock resistance	Conforming to IEC 60068-2-27	50 gn, duration 11 ms			
Output state indication		No			
Rated supply voltage		$\overline{\text{---}}$ 12...24 V			
Voltage limits (including ripple)		$\overline{\text{---}}$ 10...36 V			
Repeat accuracy		\pm 3 %			
Linearity error		\pm 2 mA			
Current consumption, no-load		\leq 4 mA with overload and short-circuit protection			
Maximum operating frequency		2000 Hz	1000 Hz	100 Hz	
Output current drift		\leq 10 % (throughout the operating temperature range)			

Dimensions

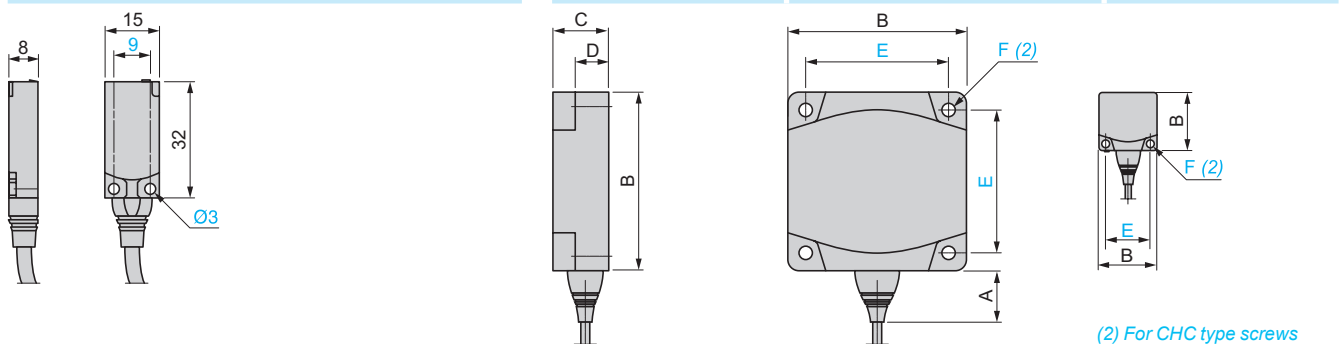

Type	A (L2)	A (M12)	B	C	D	E	F
XS9E	14	–	26	13	8.8	20	3.5
XS9C	14	–	40	15	9.8	33	4.5
XS9D	23	14	80	26	16	65	5.5

(2) For CHC type screws

Setting-up (Minimum mounting distances (mm))

Type	Side by side	Face to face	Facing a metal object
XS9F	$e \geq 15$	$e \geq 36$	$e \geq 15$
XS9E	$e \geq 30$	$e \geq 72$	$e \geq 30$
XS9C	$e \geq 45$	$e \geq 110$	$e \geq 45$
XS9D	$e \geq 120$	$e \geq 300$	$e \geq 120$

(1) For a 5 m long cable replace L2 by L5; for a 10 m long cable replace L2 by L10.
Example: XS9F111A2L2 becomes XS9F111A2L5 with a 5 m long cable.

Inductive proximity sensors

XS range, Application

Sensors with analogue output signal 0...10 V ⁽¹⁾ or 4...20 mA. Plastic case, 40 x 40 mm front face
5 position turret head

Sensor	Non flush mountable in metal	
Dimensions	40 x 40 x 70 mm	40 x 40 x 117 mm

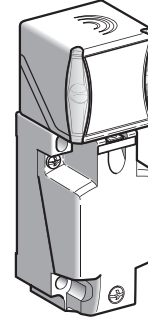
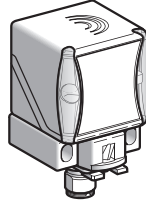

Nominal sensing distance (Sn)	25 mm
--------------------------------------	-------

References

3-wire ---	0...10 V output ⁽¹⁾	XS9C2A2A1M12	XS9C4A2A1P20 ⁽²⁾
2-wire ---	4...20 mA output	XS9C2A2A2M12	XS9C4A2A2P20 ⁽²⁾

XS9C4●●●P20 sensors are available with an ISO M20 cable entry and can be supplied with a PG 13.5 (e.g. **XS9C4A2A1G13**) or a 1/2" NPT (e.g. **XS9C4A2A2N12**) cable entry: please consult our Customer Care Centre for more information.

Weight (kg)	0.149	0.244
--------------------	-------	-------

Characteristics

Product certifications	UL, CSA, CE	
Conformity to standards	IEC 60947-5-2 and IEC 60947-5-7	
Connection	M12 connector (4-pin)	Screw terminals, clamping capacity 3 x 1.5 mm ² / 3 x 16 AWG
Operating zone	2...27 mm	
Linearity error	< 3%	
Repeat accuracy	< 3%	
Output current drift	< 5%	
Degree of protection	Conforming to IEC 60529 and DIN 40050	IP 65, IP 67 and IP 69K
Temperature	Storage	- 40...+ 85°C
	Operation ⁽³⁾	- 25...+ 70°C
Material	Case: PBT	
Vibration resistance	Conforming to IEC 60068-2-6	25 gn, amplitude \pm 2 mm (f = 10...55 Hz)
Shock resistance	Conforming to IEC 60068-2-27	50 gn for 11 ms
Indicators	Output state (alignment aid)	Yellow LED
Rated supply voltage	4...20 mA	--- 12...24 V with protection against reverse polarity
	0...10 V	--- 24 V with protection against reverse polarity
Voltage limits (including ripple)	4...20 mA	--- 12...36 V
	0...10 V	--- 15...36 V
Current consumption, no-load	3-wire ---	< 4 mA
Delays	First-up	< 7 ms
	Response	< 6 ms
	Recovery	< 6 ms

Analogue outputs 4-20 mA and 0-10 V

XS9C2A2A2M12 and XS9C4A2A2P20	XS9C2A2A1M12 and XS9C4A2A1P20
--------------------------------------	--------------------------------------

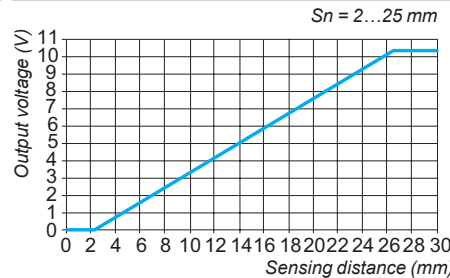
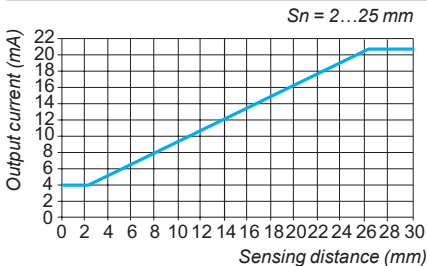

⁽¹⁾ Voltage range only obtained with a load impedance of 1000 Ω .

⁽²⁾ These sensors are supplied without a cable gland. An adaptable PG 13.5 cable gland is available (reference **XSZPE13**).

⁽³⁾ Sensors are available for very low temperatures (suffix **TF**: - 40°C, + 70°C) or very high temperatures (suffix **TT**: - 25°C, + 85°C); please consult our Customer Care Centre.

Inductive proximity sensors

XS range, Application

Sensors with analogue output signal 0...10 V ⁽¹⁾ or 4...20 mA. Plastic case, 40 x 40 mm front face
5 position turret head

Setting-up precautions

Minimum mounting distances (mm)

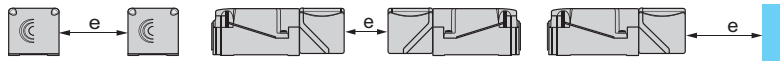

Side by side

Face to face

Facing a metal object

Sensors non flush mountable in metal

$e \geq 120$

$e \geq 240$

$e \geq 90$

Wiring schemes

2-wire

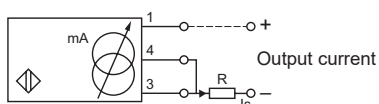

Output current

Load impedance value

12 V	4...20 mA	$R \leq 82 \Omega$
24 V	4...20 mA	$R \leq 560 \Omega$

Ensure a minimum of 10 V between the + and the - (terminal 3) of the sensor.

3-wire

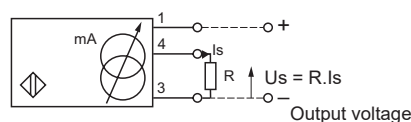

Output voltage

Output current

Load impedance value

Output voltage

Load impedance value

12 V	0...10 mA	$R \leq 630 \Omega$	-	-
24 V	0...10 mA	$R \leq 1500 \Omega$	0...10 V	$R = 1000 \Omega$

Ensure a minimum of 5 V between the + and the sensor output (terminal 4).

Dimensions

XS9C2A2A1M12 and XS9C2A2A2M12

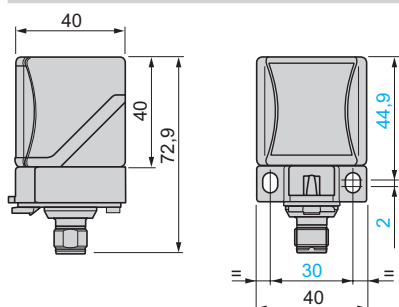

Head positions

XS9C2A2A1M12 and XS9C2A2A2M12

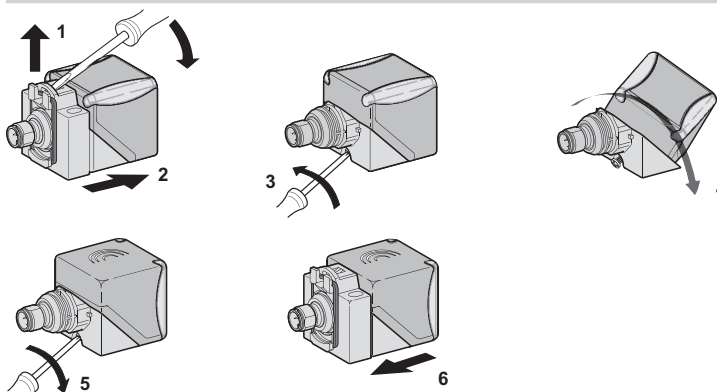

XS9C4A2A1P20 and XS9C4A2A2P20

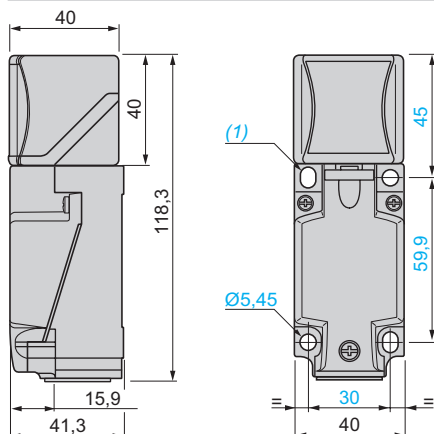

XS9C4A2A1P20 and XS9C4A2A2P20

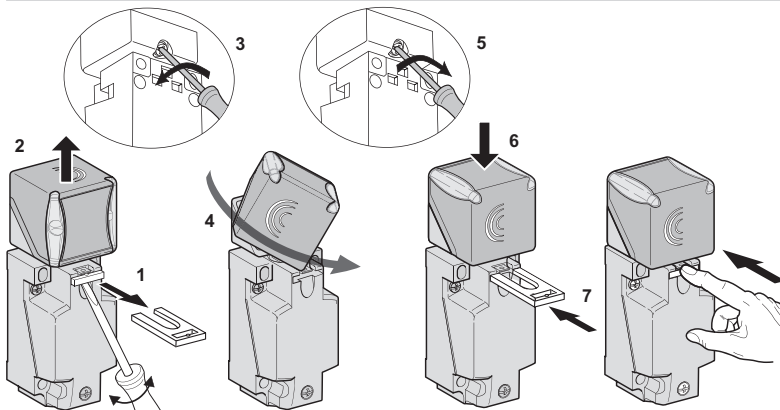

(1) 2 elongated holes $\varnothing 5.3 \times 7$ mm.

Tightening torque of cover fixing screws and clamp screws: $< 1.2 \text{ N.m} / < 10.62 \text{ lb-in}$

(1) Voltage range only obtained with a load impedance of 1000Ω .

Inductive proximity sensors

XS range, Application

Cylindrical, stainless steel 316L front face
for food and beverage applications and harsh industrial
environments. Three-wire DC, solid-state output

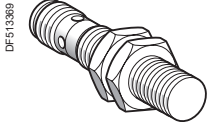

XS912●1PAM12

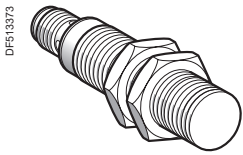

XS918●1PAM12

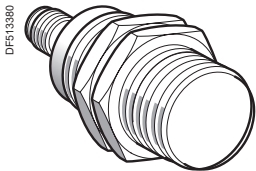

XS930●1PAM12

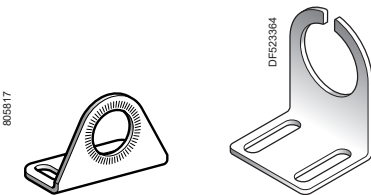

XUZA118

XSZBS30

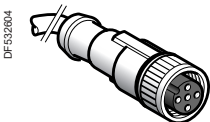

XZCP1141L●

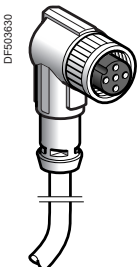

XZCP1241L●

Ø 12 mm, threaded M12 x 1

Sensing distance (Sn) mm	Function	Output	Connection	Reference	Weight kg
Three-wire 12-24V DC, flush mountable					
6	NO	PNP	M12	XS912S1PAM12	0.024

Three-wire 12-24V DC, non flush mountable

10	NO	PNP	M12	XS912S4PAM12	0.023
----	----	-----	-----	--------------	-------

Ø 18 mm, threaded M18 x 1

Sensing distance (Sn) mm	Function	Output	Connection	Reference	Weight kg
Three-wire 12-24V DC, flush mountable					
10	NO	PNP	M12	XS918S1PAM12	0.051

Three-wire 12-24V DC, non flush mountable

20	NO	PNP	M12	XS918S4PAM12	0.051
----	----	-----	-----	--------------	-------

Ø 30 mm, threaded M30 x 1.5

Sensing distance (Sn) mm	Function	Output	Connection	Reference	Weight kg
Three-wire 12-24V DC, flush mountable					
20	NO	PNP	M12	XS930S1PAM12	0.140

Three-wire 12-24V DC, non flush mountable

40	NO	PNP	M12	XS930S4PAM12	0.145
----	----	-----	-----	--------------	-------

Accessories

Description	For use with sensor	Reference	Weight kg
Stainless steel mounting bracket	Ø 12	XSZBS12	0.090
	Ø 18	XUZA118	0.190
	Ø 30	XSZBS30	0.370

Connecting cables (PVC) (1)

Description	Type	Length m	Reference	Weight kg
Pre-wired M12 connectors Female, 4-pin Stainless steel clamping ring	Straight	2	XZCPA1141L2	0.090
		5	XZCPA1141L5	0.190
		10	XZCPA1141L10	0.370
	Elbowed	2	XZCPA1241L2	0.090
		5	XZCPA1241L5	0.190
		10	XZCPA1241L10	0.370

Wiring schemes

M12 connector



PNP

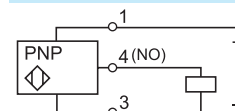

(1) For further information, please consult our site www.tesensors.com.

Characteristics				
Sensor type	Flush	XS912S1PAM12	XS918S1PAM12	XS930S1PAM12
	Non flush	XS912S4PAM12	XS918S4PAM12	XS930S4PAM12
Product certifications		CE, cULus, ECOLAB		
Connection	Connector	M12		
Operating zone	Flush	mm 0...4.8	0...8	0...16
	Non flush	mm 0...8	0...16	0...32
Differential travel		% 1...15 (real sensing distance Sr)		
Degree of protection	Conforming to IEC 60529	IP 68 (5 meters underwater for 1 month)		
	Conforming to DIN 40050	IP 69K		
Storage temperature		°C -25...+85 (-13...185°F)		
Operating temperature		°C -25...+85 (-13...185°F)		
Materials	Case	Stainless steel 316L		
Front face thickness		mm 0.4	0.6	1.0
Mechanical shock resistance	Conforming to IEC 62262	IK10		
Vibration resistance	Conforming to IEC 60068-2-6	25 gn, amplitude ± 1 mm (f = 10 to 55 Hz)		
Shock resistance	Conforming to IEC 60068-2-27	30 gn, duration 11 ms		
Output state indication		Yellow LED, 4 viewing points at 90° (blinking from 0.8 Sr and Sr)		
Rated supply voltage		V $\bar{\bar{}}$ 12...24 with protection against reverse polarity		
Voltage limits (including ripple)		V $\bar{\bar{}}$ 10...30		
Switching capacity		mA ≤ 200 with overload and short-circuit protection		
Voltage drop, closed state		V ≤ 2		
Current consumption, no-load		mA ≤ 10		
Maximum switching frequency	Flush	Hz 600	300	100
	Non flush	Hz 400	200	90
Delays	First set-up	ms 40		
	Response	µs 0.06		
	Recovery	µs 15		

Setting-up

Minimum mounting distances in mm, flush version

Side by side		Face to face	Facing a metal object	Mounted in a metal support
Ø 12	e ≥ 38	e ≥ 30	e ≥ 20	d ≥ 24
Ø 18	e ≥ 42	e ≥ 40	e ≥ 30	d ≥ 50
Ø 30	e ≥ 80	e ≥ 70	e ≥ 60	d ≥ 90

Minimum mounting distances in mm, non flush version

Side by side		Face to face	Facing a metal object	Mounted in a metal support
Ø 12	e ≥ 108	e ≥ 40	e ≥ 30	d ≥ 30 h ≥ 22
Ø 18	e ≥ 182	e ≥ 70	e ≥ 60	d ≥ 60 h ≥ 34
Ø 30	e ≥ 270	e ≥ 130	e ≥ 120	d ≥ 120 h ≥ 34

Dimensions

	Flush sensor			Non flush sensor		
	M12	M18	M30	M12	M18	M30
a (mm)	60	63.5	63.5	60	63.5	63.5
b (mm)	41	42	42	36	35	32
c (mm)	0	0	0	5	7	10

Lengths (mm):
a = overall
b = threaded
c = for non flush mountable sensors

Reduction coefficient

Flush-non mounted		Flush sensor			Non flush sensor		
		M12	M18	M30	M12	M18	M30
Steel		1	1	1	1	1	1
Aluminum		1	1	1	1	1	1
Brass		1.3	1.2	1.3	1.4	1.35	1.2
Copper		0.85	0.8	0.9	0.8	0.9	0.9
Stainless steel	Thickness 1 mm	0.5	0.5	0.35	(1)	0.3	(1)
	Thickness 2 mm	0.9	0.9	0.7	0.66	0.6	0.25
Flush mounted		M12	M18	M30	(1) No detection.		
Steel		0.7	0.75	0.9			
Aluminum		1.15	0.9	0.7			
Brass		1.05	0.75	0.6			
Stainless steel		0.8	0.8	1.3			

Inductive proximity sensors

XS range, Application, food and beverage processing series
Cylindrical, stainless steel, non flush mountable
Three-wire DC, solid-state output

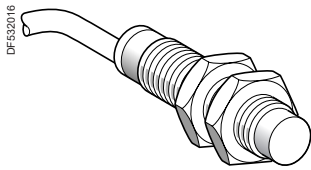

XS212SA L2

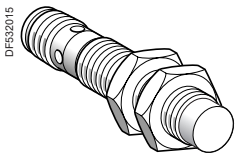

XS218SA M12

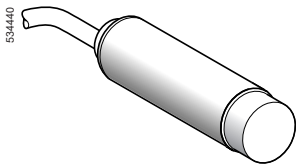

XS2L2SA L2

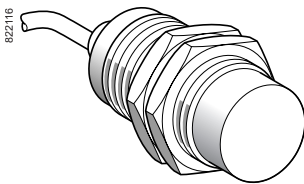

XS230SA L2

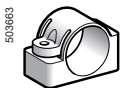

XUZB2005

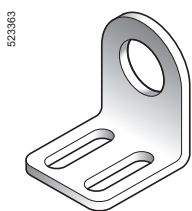

XSZBS12



XUZA118

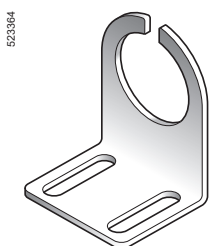

XSZBS30

Ø 12, threaded M12 x 1

Sensing distance (Sn) mm	Function	Output	Connection	Reference	Weight kg
7	NO	PNP	Pre-cabled (L = 2 m) (1)	XS212SAPAL2	0.075
			M12 connector	XS212SAPAM12	0.035
		NPN	Pre-cabled (L = 2 m) (1)	XS212SANAL2	0.075
			M12 connector	XS212SANAM12	0.035

Ø 18, threaded M18 x 1

Sensing distance (Sn) mm	Function	Output	Connection	Reference	Weight kg
12	NO	PNP	Pre-cabled (L = 2 m) (1)	XS218SAPAL2	0.120
			M12 connector	XS218SAPAM12	0.060
		NPN	Pre-cabled (L = 2 m) (1)	XS218SANAL2	0.120
			M12 connector	XS218SANAM12	0.060

Ø 18, plain

Sensing distance (Sn) mm	Function	Output	Connection	Reference	Weight kg
12	NO	PNP	Pre-cabled (L = 2 m) (1)	XS2L2SAPAL2	0.120
			M12 connector	XS2L2SAPAM12	0.060
		NPN	Pre-cabled (L = 2 m) (1)	XS2L2SANAL2	0.120
			M12 connector	XS2L2SANAM12	0.060

Ø 30, threaded M30 x 1.5

Sensing distance (Sn) mm	Function	Output	Connection	Reference	Weight kg
22	NO	PNP	Pre-cabled (L = 2 m) (1)	XS230SAPAL2	0.205
			M12 connector	XS230SAPAM12	0.145
		NPN	Pre-cabled (L = 2 m) (1)	XS230SANAL2	0.205
			M12 connector	XS230SANAM12	0.145

Accessories (2)

Description	For use with	Reference	Weight kg
Plastic fixing clamp , 24.1 mm centres, with locking screw	Ø 18 sensor, plain case	XUZB2005	0.007
Stainless steel fixing bracket	Ø 12 sensor	XSZBS12	0.060
	Ø 18 sensor	XUZA118	0.045
	Ø 30 sensor	XSZBS30	0.080

Connecting cables

Description	Type	Length m	Reference	Weight kg
Pre-wired M12 connectors Female, 4-pin, stainless steel clamping ring	Straight	2	XZCPA1141L2	0.090
		5	XZCPA1141L5	0.210
		10	XZCPA1141L10	0.410
	Elbowed	2	XZCPA1241L2	0.090
		5	XZCPA1241L5	0.210
		10	XZCPA1241L10	0.410
M12 jumper cable Male, 3-pin, stainless steel clamping ring	Straight	2	XZCRA151140A2	0.095
		5	XZCRA151140A5	0.200

(1) For a 5 m long cable replace L2 by L5; for a 10 m long cable replace L2 by L10.

Example: **XS212SAPAL2** becomes **XS212SAPAL5** with a 5 m long cable.

(2) For further information, see page 118.

Characteristics

Sensor type		XS2●●SA●●M12	XS2●●SA●●L2
Product certifications/approvals		UL, CSA, CE	
Connection	Connector	M12	–
	Pre-cabled	–	Length: 2 m
Operating zone	∅ 12	mm 0...5.6	
	∅ 18	mm 0...9.6	
	∅ 30	mm 0...17.6	
Differential travel		%	
Degree of protection		1...15 of effective sensing distance (Sr)	
Storage temperature	Conforming to IEC 60529	IP 67	IP 68, double insulation
	DIN 40050	IP 69K	
Operating temperature		°C	
Materials		Stainless steel 316 L	
Vibration resistance	Case	–	Non-poisonous PVC, 3 x 0.34 mm ²
	Cable		
Shock resistance		25 gn, amplitude ± 2 mm (f = 10 to 55 Hz)	
Output state indication		Yellow LED: 4 viewing ports at 90°	
Rated supply voltage		Yellow LED: annular	
Voltage limits (including ripple)		V	
Switching capacity		≤ 200 with overload and short-circuit protection	
Voltage drop, closed state		V	
Current consumption, no-load		mA	
Maximum switching frequency		Hz	
Delays	First-up	ms	
	Response	ms	
	Recovery	ms	

(1) + 100 °C for cleaning and sterilization phases whilst not in service.

Wiring schemes

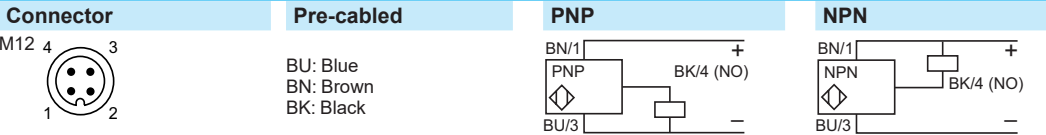

Setting-up

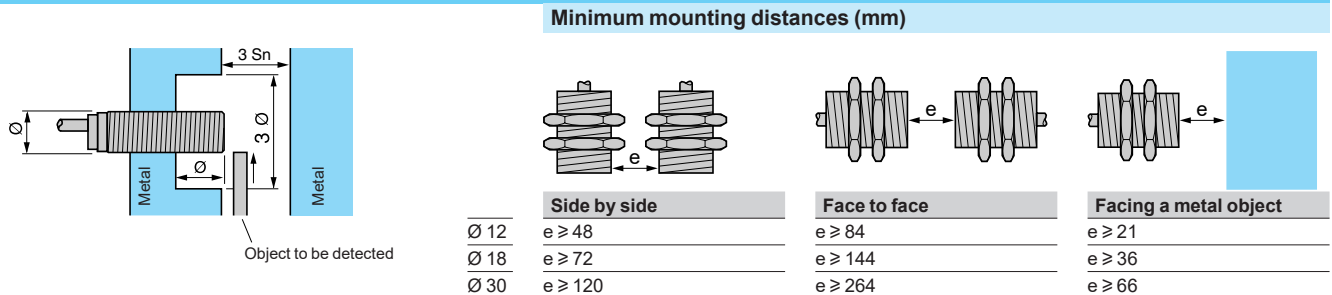

Dimensions

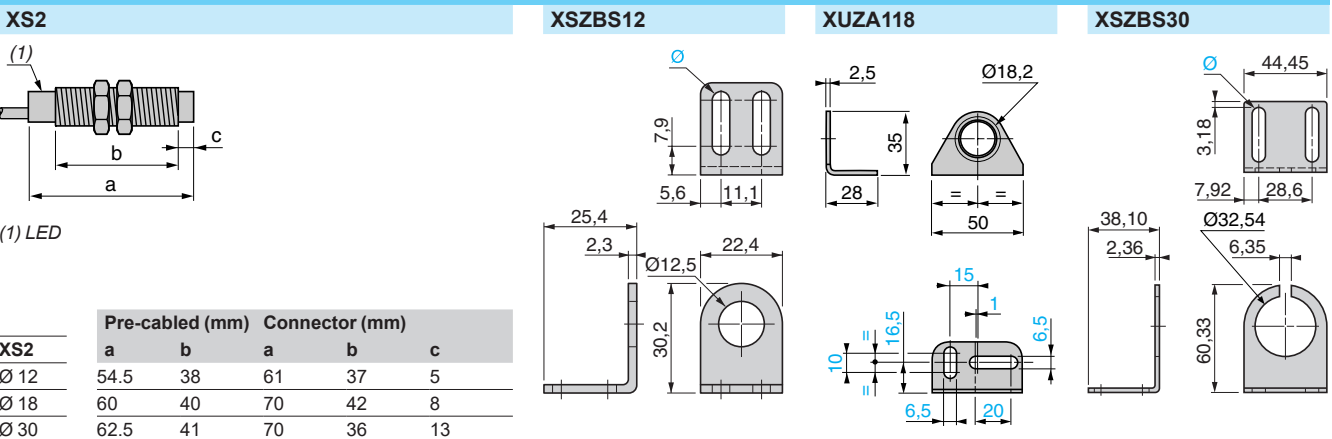

Inductive proximity sensors

XS range, Application

Food and beverage processing series

Cylindrical, stainless steel, non flush mountable

Two-wire AC or DC

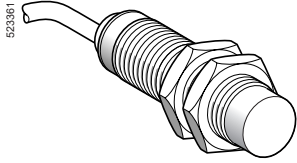

XS218SAM•L2

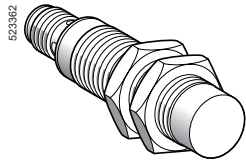

XS218SAM•U20

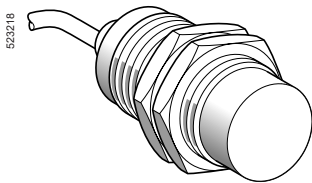

XS230SAM•L2

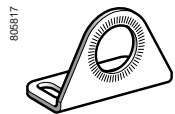

XUZA118

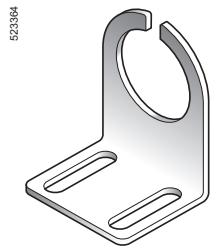

XSZBS30

Ø 18, threaded M18 x 1				
Sensing distance (Sn) mm	Function	Connection	Reference	Weight kg
12	NO	Pre-cabled (L = 2 m) (1)	XS218SAMAL2	0.120
		1/2"-20UNF connector	XS218SAMAU20	0.060

Ø 30, threaded M30 x 1.5				
Sensing distance (Sn) mm	Function	Connection	Reference	Weight kg
22	NO	Pre-cabled (L = 2 m) (1)	XS230SAMAL2	0.205
		1/2"-20UNF connector	XS230SAMAU20	0.145

Connecting cables				
Description	Type	Length m	Reference	Weight kg
Pre-wired connectors 1/2"-20UNF 3-pin female, stainless steel clamping ring	Straight	5	XZCPA1865L5	0.210
		10	XZCPA1865L10	0.410
	Elbowed	5	XZCPA1965L5	0.250
		10	XZCPA1965L10	0.485

Accessories				
Description	For use with	Reference	Weight kg	
Stainless steel fixing brackets	Ø 18 sensor	XUZA118	0.045	
	Ø 30 sensor	XSZBS30	0.080	

(1) For a 5 m long cable replace L2 by L5; for a 10 m long cable replace L2 by L10.
Example: XS218SAMAL2 becomes XS218SAMAL5 with a 5 m long cable.

Characteristics

		XS2●●SAM●U20	XS2●●SAM●L2
Sensor type			
Product certifications/approvals		UL, CSA, CE	
Connection	Connector	1/2"-20UNF	-
	Pre-cabled	-	Length: 2 m
Operating zone	Ø 18	mm 0...9.6	
	Ø 30	mm 0...17.6	
Differential travel		%	
		1...15 of effective sensing distance (Sr)	
Degree of protection	Conforming to IEC 60529	IP 67	IP 68, double insulation ☑
	DIN 40050	IP 69K	
Storage temperature		°C	
		- 40...+ 85 (1)	
Operating temperature		°C	
		- 25...+ 85	
Materials	Case	Stainless steel 316 L	
	Cable	-	Non-poisonous PVC, 2 x 0.34 mm ²
Vibration resistance		25 gn, amplitude ± 2 mm (f = 10 to 55 Hz)	
Shock resistance		50 gn, duration 11 ms	
Output state indication		Yellow LED: 4 viewing ports at 90°	Yellow LED: annular
Rated supply voltage		V	
		~ or - 24...240 (~ 50/60 Hz)	
Voltage limits (including ripple)		V	
		~ or - 20...264	
Switching capacity		mA	
		~ 5...300 or - 5...200 (2)	
Voltage drop, closed state		V	
		≤ 5.5	
Residual current, open state		mA	
		≤ 0.8	
Maximum switching frequency	XS218SAM●●●	Hz	
	XS230SAM●●●	Hz	
		~ 25 or - 1000	
		~ 25 or - 300	
Delays	First-up	ms	
	Response	ms	
	Recovery	ms	
		≤ 0.5 XS218SAM●●●, ≤ 2 XS230SAM●●●	

(1) + 100 °C for cleaning and sterilization phases whilst not in service.

(2) It is essential to connect a 0.4 A "quick-blow" fuse in series with the load.

Wiring schemes

Connector

1/2"-20UNF



AC/DC: 2
⊕ : 1
AC/DC: 3

Pre-cabled

BU: Blue
BN: Brown

2-wire ~ or -

NO output

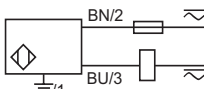

⊕: on connector models only

Setting-up

Minimum mounting distances (mm)

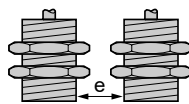
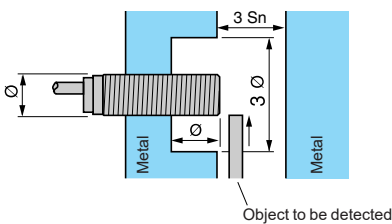

Side by side

Ø 18 e ≥ 72
Ø 30 e ≥ 120

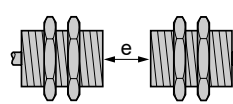

Face to face

e ≥ 144
e ≥ 264

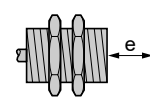

Facing a metal object

e ≥ 36
e ≥ 66

Dimensions

XS2

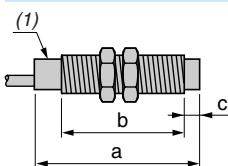

(1) LED

XSZA118

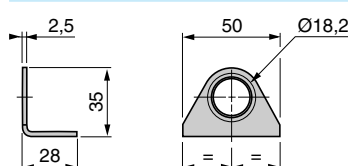

XSZBS30

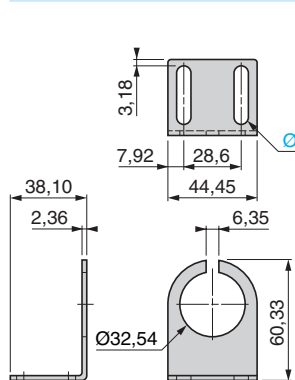

XS2	Pre-cabled (mm)		Connector (mm)		
	a	b	a	b	c
Ø 18	60	40	72	44	8
Ø 30	62.5	41	74	40	13

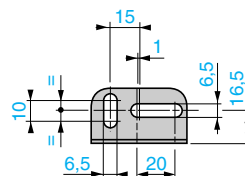

Ø: 2 elongated holes Ø 7.14 x 29.36

Inductive proximity sensors

XS range, Application, food and beverage processing series
Cylindrical, plastic, non flush mountable
Three-wire DC, solid-state output

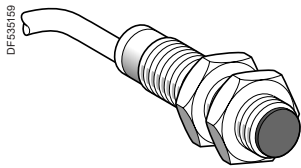

XS2●●AA●●L2

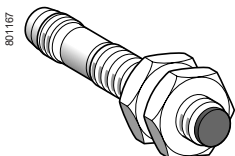

XS2●●AA●●M12

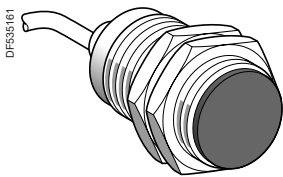

XS230AA●●L2

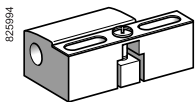

XSZB●●●

Ø 12, threaded M12 x 1

Sensing distance (Sn) mm	Function	Output	Connection	Reference	Weight kg
7	NO	PNP	Pre-cabled (L = 2 m) (1)	XS212AAPAL2	0.065
			M12 connector	XS212AAPAM12	0.030
		NPN	Pre-cabled (L = 2 m) (1)	XS212AANAL2	0.065
			M12 connector	XS212AANAM12	0.030

Ø 18, threaded M18 x 1

Sensing distance (Sn) mm	Function	Output	Connection	Reference	Weight kg
12	NO	PNP	Pre-cabled (L = 2 m) (1)	XS218AAPAL2	0.100
			M12 connector	XS218AAPAM12	0.040
		NPN	Pre-cabled (L = 2 m) (1)	XS218AANAL2	0.100
			M12 connector	XS218AANAM12	0.040

Ø 30, threaded M30 x 1.5

Sensing distance (Sn) mm	Function	Output	Connection	Reference	Weight kg
22	NO	PNP	Pre-cabled (L = 2 m) (1)	XS230AAPAL2	0.140
			M12 connector	XS230AAPAM12	0.080
		NPN	Pre-cabled (L = 2 m) (1)	XS230AANAL2	0.140
			M12 connector	XS230AANAM12	0.080

Accessories (2)

Description		Reference	Weight kg
Fixing clamps	Ø 12	XSZB112	0.006
	Ø 18	XSZB118	0.010
	Ø 30	XSZB130	0.020

Connecting cables

Description	Type	Length m	Reference	Weight kg
Pre-wired M12 connectors Female, 4-pin, stainless steel clamping ring	Straight	2	XZCPA1141L2	0.090
		5	XZCPA1141L5	0.190
		10	XZCPA1141L10	0.370
	Elbowed	2	XZCPA1241L2	0.090
		5	XZCPA1241L5	0.190
		10	XZCPA1241L10	0.370
M12 jumper cable Male, 3-pin, stainless steel clamping ring	Straight	2	XZCRA151140A2	0.090
		5	XZCRA151140A5	0.190

(1) For a 5 m long cable replace L2 by L5; for a 10 m long cable replace L2 by L10.
Example: **XS212AAPAL2** becomes **XS212AAPAL5** with a 5 m long cable.

(2) For further information, see page 118.

Characteristics		XS2●●AA●●M12	XS2●●AA●●L2
Sensor type		UL, CSA, CE	
Product certifications/approvals		UL, CSA, CE	
Connection	Connector	M12	–
	Pre-cabled	–	Length: 2 m
Operating zone	Ø 12	mm	0...5.6
	Ø 18	mm	0...9.6
	Ø 30	mm	0...17.6
Differential travel		%	1...15 of effective sensing distance (Sr)
Degree of protection	Conforming to IEC 60529	IP 67	IP 68, double insulation □
	DIN 40050	IP 69K	
Storage temperature		°C	-40...+85
Operating temperature		°C	-25...+85
Materials	Case	PPS	
	Cable	–	PvR and 3 x 0.34 mm ²
Vibration resistance	Conforming to IEC 60068-2-6	25 gn, amplitude ± 2 mm (f = 10 to 55 Hz)	
Shock resistance	Conforming to IEC 60068-2-27	50 gn, duration 11 ms	
Output state indication		Yellow LED: annular	
Rated supply voltage		V	≈ 12...48 for T - 25...+85 °C
Voltage limits (including ripple)		V	≈ 10...58 for T - 25...+85 °C
Switching capacity		mA	≤ 200 with overload and short-circuit protection
Voltage drop, closed state		V	≤ 2
Current consumption, no-load		mA	≤ 10
Maximum switching frequency	XS212AA●●●●	Hz	2500
	XS218AA●●●●	Hz	1000
	XS230AA●●●●	Hz	500
Delays	First-up	ms	≤ 10
	Response	ms	≤ 0.2 Ø 12, ≤ 0.3 Ø 18, ≤ 0.6 Ø 30
	Recovery	ms	≤ 0.2 Ø 12, ≤ 0.7 Ø 18, ≤ 1.4 Ø 30

Wiring schemes

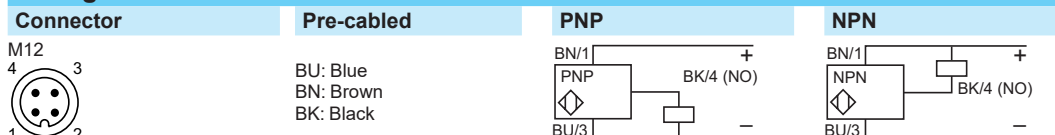

Setting-up

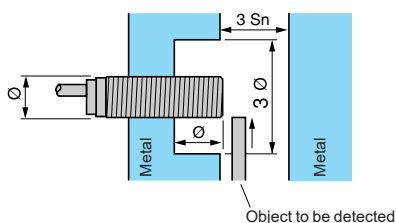

Minimum mounting distances (mm)

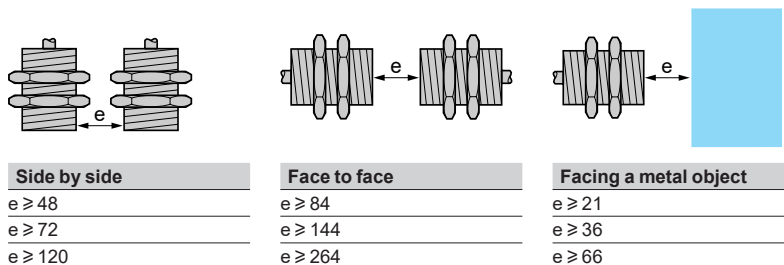

Dimensions

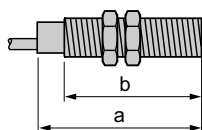

XS2	Pre-cabled (mm)		Connector (mm)	
	a	b	a	b
Ø 12	50	42	61	43
Ø 18	60	51	70	52
Ø 30	60	51	70	52

Inductive proximity sensors

XS range Application, food and beverage processing series
Cylindrical, plastic, non flush mountable
Two-wire AC or DC

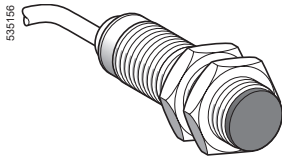

XS2●●AAM●L2

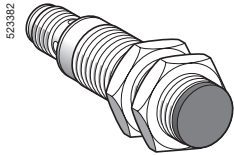

XS2●●AAM●U20

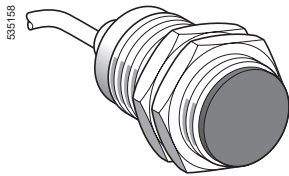

XS230AAM●L2

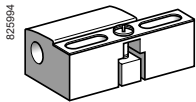

XSZB1●●

Ø 18, threaded M18 x 1

Sensing distance (Sn) mm	Function	Connection	Reference	Weight kg
12	NO	Pre-cabled (L = 2 m) (1)	XS218AAMAL2	0.100
		1/2"-20UNF connector	XS218AAMAU20	0.040

Ø 30, threaded M30 x 1.5

Sensing distance (Sn) mm	Function	Connection	Reference	Weight kg
22	NO	Pre-cabled (L = 2 m) (1)	XS230AAMAL2	0.140
		1/2"-20UNF connector	XS230AAMAU20	0.080

Accessories (2)

Description		Reference	Weight kg
Fixing clamps	Ø 18	XSZB118	0.010
	Ø 30	XSZB130	0.020

Connecting cables

Description	Type	Length m	Reference	Weight kg
Pre-wired connectors 1/2"-20UNF 3-pin female, stainless steel 316 L clamping ring	Straight	5	XZCPA1865L5	0.180
		10	XZCPA1865L10	0.350
	Elbowed	5	XZCPA1965L5	0.180
		10	XZCPA1965L10	0.350

(1) For a 5 m long cable replace L2 by L5; for a 10 m long cable replace L2 by L10.

Example: **XS218AAMAL2** becomes **XS218AAMAL5** with a 5 m long cable.

(2) For further information, see page 118.

Characteristics		XS2●●AAM●U20	XS2●●AAM●L2
Sensor type		UL, CSA, CE	
Product certifications/approvals		UL, CSA, CE	
Connection	Connector	1/2"-20UNF	—
	Pre-cabled	—	Length: 2 m
Operating zone	∅ 18	mm 0...9.6	
	∅ 30	mm 0...17.6	
Differential travel		1...15 of effective sensing distance (Sr)	
Degree of protection	Conforming to IEC 60529	IP 67	IP 68, double insulation □
	DIN 40050	IP 69K	
Storage temperature		°C - 40...+ 85	
Operating temperature		°C - 25...+ 85	
Materials	Case	PPS	
	Cable	—	PvR and 2 x 0.34 mm ²
Vibration resistance		25 gn, amplitude ± 2 mm (f = 10 to 55 Hz)	
Shock resistance		50 gn, duration 11 ms	
Output state indication		Yellow LED: annular	
Rated supply voltage		V ~ or ≡ 24...240 (~ 50/60 Hz)	
Voltage limits (including ripple)		V ~ or ≡ 20...264	
Switching capacity		mA ~ 5...300 or ≡ 5...200 (1)	
Voltage drop, closed state		V ≤ 5.5	
Residual current, open state		mA ≤ 0.8	
Maximum switching frequency	XS218AAM●●●	Hz ~ 25 or ≡ 1000	
	XS230AAM●●●	Hz ~ 25 or ≡ 300	
Delays	First-up	ms ≤ 30	
	Response	ms ≤ 0.5	
	Recovery	ms ≤ 0.5 XS218AAM●●●, ≤ 2 XS230AAM●●●	

(1) It is essential to connect a 0.4 A "quick-blow" fuse in series with the load.

Wiring schemes

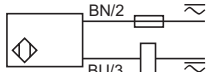
Connector	Pre-cabled	2-wire ~ or ≡
1/2"-20UNF	BU: Blue BN: Brown	NO output
		

Setting-up

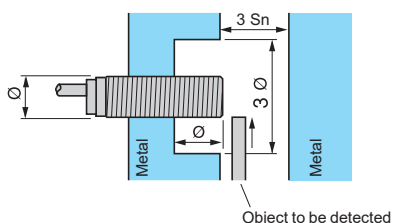

Minimum mounting distances (mm)

	Side by side	Face to face	Facing a metal object
∅ 18	e ≥ 72	e ≥ 144	e ≥ 36
∅ 30	e ≥ 120	e ≥ 264	e ≥ 66

Dimensions

XS2

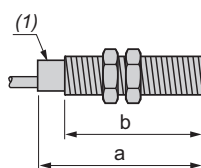

(1) LED

XS2	Pre-cabled (mm)		Connector (mm)	
	a	b	a	b
∅ 18	60	51	70	52
∅ 30	60	51	70	52

Inductive proximity sensors

XS range, Application
Cylindrical, stainless steel 303 front face
for harsh industrial environments
Three-wire DC, solid-state output

DF513376

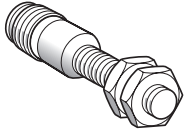

XS908●1PAM12

DF513389

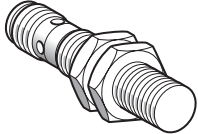

XS912●1PAM12

DF513373

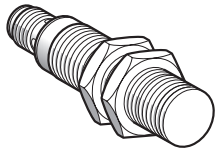

XS918●1PAM12

DF513380

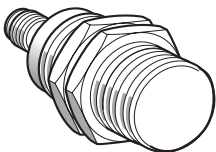

XS930●1PAM12

DF532804



XZCP1141L●

DF503830

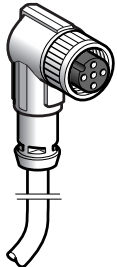

XZCP1241L●

Ø 8 mm, threaded M8 x 1

Sensing distance (Sn) mm	Function	Output	Connection	Reference	Weight kg
Three-wire 12-24V $\overline{\text{DC}}$, flush mountable					
3	NO	PNP	M12	XS908R1PAM12	0.018

Three-wire 12-24V $\overline{\text{DC}}$, non flush mountable

6	NO	PNP	M12	XS908R4PAM12	0.018
---	----	-----	-----	--------------	-------

Ø 12 mm, threaded M12 x 1

Sensing distance (Sn) mm	Function	Output	Connection	Reference	Weight kg
Three-wire 12-24V $\overline{\text{DC}}$, flush mountable					
6	NO	PNP	M12	XS912R1PAM12	0.024

Three-wire 12-24V $\overline{\text{DC}}$, non flush mountable

10	NO	PNP	M12	XS912R4PAM12	0.023
----	----	-----	-----	--------------	-------

Ø 18 mm, threaded M18 x 1

Sensing distance (Sn) mm	Function	Output	Connection	Reference	Weight kg
Three-wire 12-24V $\overline{\text{DC}}$, flush mountable					
10	NO	PNP	M12	XS918R1PAM12	0.044

Three-wire 12-24V $\overline{\text{DC}}$, non flush mountable

20	NO	PNP	M12	XS918R4PAM12	0.051
----	----	-----	-----	--------------	-------

Ø 30 mm, threaded M30 x 1.5

Sensing distance (Sn) mm	Function	Output	Connection	Reference	Weight kg
Three-wire 12-24V $\overline{\text{DC}}$, flush mountable					
20	NO	PNP	M12	XS930R1PAM12	0.140

Three-wire 12-24V $\overline{\text{DC}}$, non flush mountable

40	NO	PNP	M12	XS930R4PAM12	0.144
----	----	-----	-----	--------------	-------

Connecting cables (PUR) (1)

Description	Type	Length m	Reference	Weight kg
Pre-wired M12 connectors Female, 4-pin Metal clamping	Straight	2	XZCP1141L2	0.090
		5	XZCP1141L5	0.190
		10	XZCP1141L10	0.370
	Elbowed	2	XZCP1241L2	0.090
		5	XZCP1241L5	0.190
		10	XZCP1241L10	0.370

Wiring schemes

M12 connector



PNP

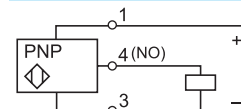

(1) For further information, please consult our site www.tesensors.com.

Inductive proximity sensors

XS range, Application
Cylindrical, stainless steel 303 front face
for harsh industrial environments
Three-wire DC, solid-state output

Characteristics						
Sensor type	Flush		XS908R1PAM12	XS912R1PAM12	XS918R1PAM12	XS930R1PAM12
	Non flush		XS908R4PAM12	XS912R4PAM12	XS918R4PAM12	XS930R4PAM12
Product certifications			CE, cULus			
Connection	Connector		M12			
Operating zone	Flush	mm	0...2.4	0...4.8	0...8	0...16
	Non flush	mm	0...4.8	0...8	0...16	0...32
Differential travel		%	1...15 (real sensing distance Sr)			
Degree of protection	Conforming to IEC 60529		IP 67	IP 68 (5 meters underwater for 1 month)		
	Conforming to DIN 40050		IP 69K			
Storage temperature		°C	-25...+70 (-13...158°F)			
Operating temperature		°C	-25...+70 (-13...158°F)			
Materials	Case		Stainless steel, 303 grade			
Front face thickness		mm	0.25	0.4	0.6	1.0
Mechanical shock resistance	Conforming to IEC 62262		IK10			
Vibration resistance	Conforming to IEC 60068-2-6		25 gn, amplitude ± 1 mm (f = 10 to 55 Hz)			
Shock resistance	Conforming to IEC 60068-2-27		30 gn, duration 11 ms			
Output state indication			Yellow LED, 4 viewing points at 90° (blinking from 0.8 Sr and Sr)			
Rated supply voltage		V	12...24 with protection against reverse polarity			
Voltage limits (including ripple)		V	10...30			
Switching capacity		mA	≤ 200 with overload and short-circuit protection			
Voltage drop, closed state		V	≤ 2			
Current consumption, no-load		mA	≤ 10			
Maximum switching frequency	Flush	Hz	1000	600	300	100
	Non flush	Hz	700	400	200	90
Delays	First set-up	ms	40			
	Response	µs	0.05	0.06		
	Recovery	µs	23	15		

Setting-up

Minimum mounting distances in mm, flush version

Side by side		Face to face	Facing a metal object	Mounted in a metal support
Ø 8	e ≥ 14	e ≥ 15	e ≥ 10	d ≥ 12
Ø 12	e ≥ 38	e ≥ 30	e ≥ 20	d ≥ 24
Ø 18	e ≥ 42	e ≥ 40	e ≥ 30	d ≥ 50
Ø 30	e ≥ 80	e ≥ 70	e ≥ 60	d ≥ 90

Minimum mounting distances in mm, non flush version

Side by side		Face to face	Facing a metal object	Mounted in a metal support
Ø 8	e ≥ 52	e ≥ 25	e ≥ 20	d ≥ 20 h ≥ 15
Ø 12	e ≥ 108	e ≥ 40	e ≥ 30	d ≥ 30 h ≥ 22
Ø 18	e ≥ 182	e ≥ 70	e ≥ 60	d ≥ 60 h ≥ 34
Ø 30	e ≥ 270	e ≥ 130	e ≥ 120	d ≥ 120 h ≥ 34

Dimensions

Lengths (mm): a = overall b = threaded c = for non flush mountable sensors	Flush sensor				Non flush sensor			
	M8	M12	M18	M30	M8	M12	M18	M30
	a (mm)	66	60	63.5	63.5	66	60	63.5
b (mm)	46	41	42	42	42	36	35	32
c (mm)	0	0	0	0	4	5	7	10

Reduction coefficient

Non flush mounted		Flush sensor				Non flush sensor			
		M8	M12	M18	M30	M8	M12	M18	M30
Steel		1	1	1	1	1	1	1	1
Aluminum		1	1	1	1	1	1	1	1
Brass		1.35	1.3	1.2	1.3	1.4	1.4	1.35	1.2
Copper		0.9	0.85	0.8	0.9	0.85	0.8	0.9	0.9
Stainless steel	Thickness 1 mm	0.3	0.5	0.5	0.35	0.3	(1)	0.3	(1)
	Thickness 2 mm	0.6	0.9	0.9	0.7	0.9	0.66	0.6	0.25
Flush mounted		M8	M12	M18	M30	(1) No detection.			
Steel		1	0.7	0.75	0.9				
Aluminum		0.9	1.15	0.9	0.7				
Brass		0.9	1.05	0.75	0.6				
Stainless steel		1	0.8	0.8	1.3				

Inductive proximity sensors

XS range, Application

For assembly, packaging and light material handling

Plastic case, 12 x 26 x 40 mm

DC supply, solid-state output

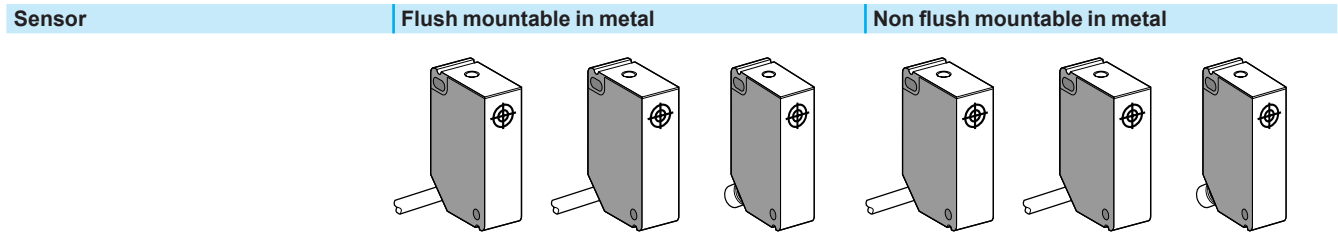

Nominal sensing distance (Sn)	2 mm	4 mm
-------------------------------	------	------

References							
3-wire $\overline{\text{---}}$	PNP NO	XS7G12PA140	–	XS7G12PA140S	XS8G12PA140	–	XS8G12PA140S
	NPN NO	XS7G12NA140	–	XS7G12NA140S	XS8G12NA140	–	XS8G12NA140S
4-wire $\overline{\text{---}}$ (complementary outputs)	PNP NO + NC	–	XS7G12PC440	–	–	XS8G12PC440	–
	NPN NO + NC	–	XS7G12NC440	–	–	XS8G12NC440	–
Weight (kg)		0.100	0.100	0.030	0.100	0.100	0.030

Characteristics							
Product certifications	CSA, UL, CE						
Connection	Pre-cabled	3 x 0.34 mm ² , length 2 m (1)	4 x 0.34 mm ² , length 2 m (1)	–	3 x 0.34 mm ² , length 2 m (1)	4 x 0.34 mm ² , length 2 m (1)	–
	Connector	–	–	M8	–	–	M8
Operating zone	0...1.6 mm			0...3.2 mm			
Repeat accuracy	≤ 10 % of Sr						
Differential travel	3...20 % of Sr						
Degree of protection	IP 67						
Storage temperature	- 40...+ 85 °C						
Operating temperature	- 25...+ 70 °C						
Materials	Case: PBT, cable: PVC						
Vibration resistance Conforming to IEC 60068-2-6	25 gn, amplitude ± 2 mm (f = 10 to 55 Hz)						
Shock resistance Conforming to IEC 60068-2-27	50 gn, duration 11 ms						
Output state indication	Yellow LED (on top of case)						
Rated supply voltage	$\overline{\text{---}}$ 12...24 V	$\overline{\text{---}}$ 12...48 V	$\overline{\text{---}}$ 12...24 V	$\overline{\text{---}}$ 12...24 V	$\overline{\text{---}}$ 12...48 V	$\overline{\text{---}}$ 12...24 V	$\overline{\text{---}}$ 12...24 V
Voltage limits (including ripple)	$\overline{\text{---}}$ 10...30 V	$\overline{\text{---}}$ 10...58 V	$\overline{\text{---}}$ 10...30 V	$\overline{\text{---}}$ 10...30 V	$\overline{\text{---}}$ 10...58 V	$\overline{\text{---}}$ 10...30 V	$\overline{\text{---}}$ 10...30 V
Current consumption, no-load	≤ 10 mA						
Switching capacity	0...100 mA (2)	0...200 mA (2)	0...100 mA (2)	0...100 mA (2)	0...200 mA (2)	0...100 mA (2)	0...100 mA (2)
Voltage drop, closed state	≤ 1.8 V	≤ 2.6 V	≤ 1.8 V	≤ 1.8 V	≤ 2.6 V	≤ 1.8 V	≤ 1.8 V
Maximum switching frequency	≤ 2 kHz			≤ 1 kHz			
Delays	First-up	≤ 4 ms					
	Response	≤ 0.5 ms					
	Recovery	≤ 1 ms					

(1) Sensors available with other cable lengths:

Length of cable	Suffix to be added to references stated above for 2 m pre-cabled sensors	Weight increase
5 m	L1	0.120 kg
10 m	L2	0.320 kg

Example: sensor **XS7G12PA140** with 5 m long cable becomes **XS7G12PA140L1**.

(2) With overload and short-circuit protection

Inductive proximity sensors

XS range, Application

For assembly, packaging and light material handling

Plastic case, 12 x 26 x 40 mm

DC supply, solid-state output

Dimensions

XS● G12●A140, XS● G12●C440

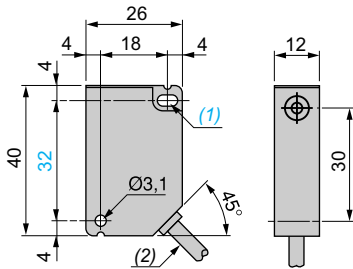

Rear view

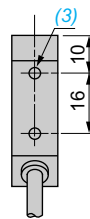

- (1) 1 elongated hole $\varnothing 3.1 \times 5.1$.
- (2) Cable $L = 2\text{ m}$.
- (3) 2 holes $M3 \times 5$.

XS● G12●A140S

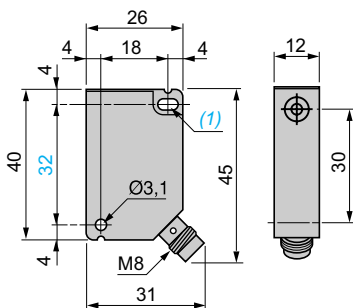

Rear view

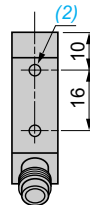

- (1) 1 elongated hole $\varnothing 3.1 \times 5.1$.
- (2) 2 holes $M3 \times 5$.

Setting-up

Minimum mounting distances (mm)

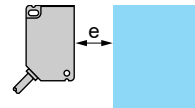
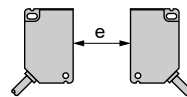
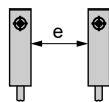

Side by side

Face to face

Facing a metal object and mounting in a metal support

XS7G flush mountable

$e \geq 0$

$e \geq 15$

$e \geq 6$

XS8G non flush mountable

$e \geq 10$

$e \geq 60$

$e \geq 12$

Wiring schemes

3-wire \dots , NO output

4-wire \dots , NO + NC output

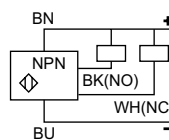
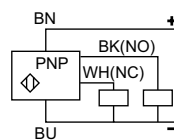
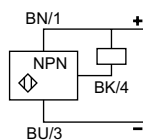
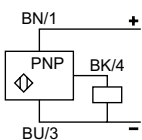

Connector

M8



Inductive proximity sensors

XS range, Application

For assembly, packaging and light material handling

Plastic case, 12 x 26 x 40 mm

AC or DC supply

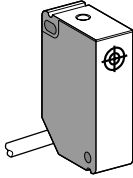
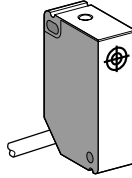
Sensor		Flush mountable in metal	Non flush mountable in metal
			
Nominal sensing distance (Sn)		2 mm	4 mm
References			
2-wire $\overline{\text{---}}$ or \sim	NO	XS7G12MA230	XS8G12MA230
	NC	XS7G12MB230	XS8G12MB230
Weight (kg)		0.100	0.100
Characteristics			
Product certifications		CSA, UL, CE	
Connection		Pre-cabled, 2 x 0.34 mm ² , length 2 m (1)	
Operating zone		0...1.6 mm	0...3.2 mm
Repeat accuracy		≤ 10 % of Sr	
Differential travel		3...20 % of Sr	
Degree of protection		IP 67	
Storage temperature		- 40...+ 85 °C	
Operating temperature		- 25...+ 70 °C	
Materials		Case: PBT, cable: PVC	
Vibration resistance Conforming to IEC 60068-2-6		25 gn, amplitude ± 2 mm (f = 10 to 55 Hz)	
Shock resistance Conforming to IEC 60068-2-27		50 gn, duration 11 ms	
Output state indication		Yellow LED (on top of case)	
Rated supply voltage		\sim 24...240 V (50/60 Hz) or $\overline{\text{---}}$ 24...210 V	
Voltage limits (including ripple)		\sim or $\overline{\text{---}}$ 20...264 V	
Switching capacity		5...200 mA (2)	
Voltage drop, closed state		≤ 5.5 V	
Residual current, open state		≤ 0.8 mA/24 V, 1.5 mA/120 V	
Maximum switching frequency		\sim 25 Hz or $\overline{\text{---}}$ 250 Hz	
Delays	First-up	≤ 40 ms	
	Response	≤ 1 ms	
	Recovery	≤ 2 ms	

(1) Sensors available with other cable lengths:

Length of cable	Suffix to be added to references stated above for 2 m pre-cabled sensors	Weight increase
5 m	L1	0.120 kg
10 m	L2	0.320 kg

Example: sensor **XS7G12MA230** with 5 m long cable becomes **XS7G12MA230L1**.

(2) These sensors do not incorporate overload or short-circuit protection and therefore, it is essential to connect a 0.4 A "quick-blow" fuse in series with the load.

Inductive proximity sensors

XS range, Application

For assembly, packaging and light material handling

Plastic case, 12 x 26 x 40 mm

AC or DC supply

Dimensions

XS●G12M●230

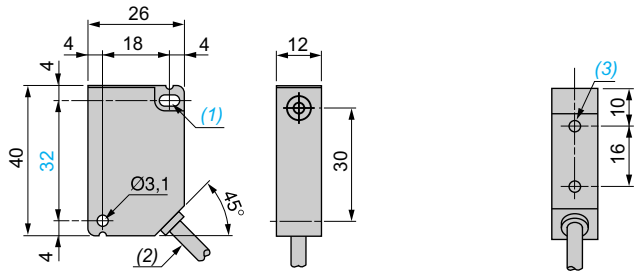

Rear view

- (1) 1 elongated hole $\varnothing 3.1 \times 5.1$.
- (2) Cable $L = 2\text{ m}$.
- (3) 2 holes $M3 \times 5$.

Setting-up

Minimum mounting distances (mm)

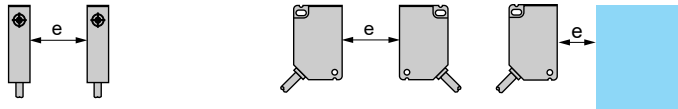

	Side by side	Face to face	Facing a metal object and mounting in a metal support
XS7G flush mountable	$e \geq 0$	$e \geq 15$	$e \geq 6$
XS8G non flush mountable	$e \geq 10$	$e \geq 60$	$e \geq 12$

Wiring schemes

2-wire \sim or \dots , NO or NC output

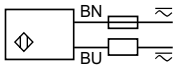

Inductive proximity sensors

XS range, Application

Flat sensor, flush mountable, increased range, switching capacity 300 mA

80 x 80 x 40 format, DIN rail mounting, solid-state output

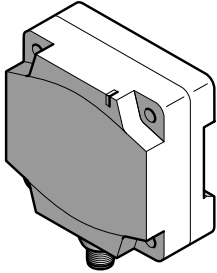
Sensor		Flush mountable in metal
		
Dimensions (mm)		80 x 80 x 40
Nominal sensing distance (Sn)		50 mm (not flush mounted: 42 mm)
Reference		
2-wire $\overline{\text{---}}$ (non polarised)	NO	XS7D1A3CAM12DIN
Weight (kg)		0.374
Characteristics		
Product certifications		CE
Degree of protection	Conforming to IEC 60529	IP 67, double insulation \square
Temperature	Operating	- 25...+ 70 °C
	Storage	- 40...+ 85 °C
Vibration resistance	Conforming to IEC 60068-2-6	25 gn, amplitude \pm 2 mm (f = 10 to 55 Hz)
Shock resistance	Conforming to IEC 60068-2-27	50 gn, duration 11 ms
Connection		M12 connector
Operating zone		0...40 mm (not flush mounted: 0...35 mm)
Repeat accuracy		3 % of Sr
Differential travel		1...15 % of Sr
Output state indication		Yellow LED
Rated supply voltage		$\overline{\text{---}}$ 12...48 V with protection against reverse polarity
Voltage limits (including ripple)		$\overline{\text{---}}$ 10...58 V
Residual current, open state		\leq 0.5 mA
Switching capacity		1.5...300 mA with overload and short-circuit protection
Voltage drop, closed state		\leq 4.5 V
Maximum switching frequency		100 Hz
Delays	First-up	\leq 10 ms
	Response	\leq 2 ms
	Recovery	\leq 5 ms

Inductive proximity sensors

XS range, Application

Flat sensor, flush mountable, increased range, switching capacity 300 mA

80 x 80 x 40 format, DIN rail mounting, solid-state output

Dimensions

XS7D1A3CAM12DIN

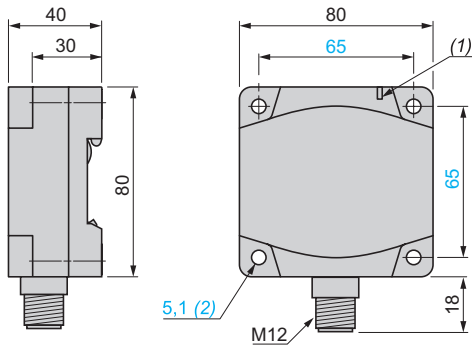

(1) Output LED

(2) For CHC type screws

Setting-up

Minimum mounting distances (mm)

	Face to face	Side by side	Back to back	Facing a metal object
Flush mounted	450	140	90	150
Not flush mounted	450	180	180	150

Flush/non flush conditions

In A37 steel



Sn	Su	Sn	Su
42 mm	35 mm	50 mm	40 mm

Wiring schemes

2-wire NO/M12 XS7D1A3CAM12DIN

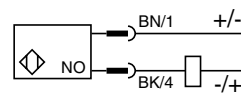

Inductive proximity sensors

XS range, Application
Cylindrical, stainless steel 303 front face
for welding environments
Three-wire DC, solid-state output

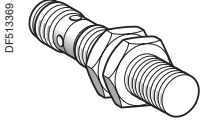

XS912RWPAM12

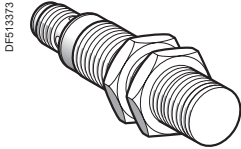

XS918RWPAM12

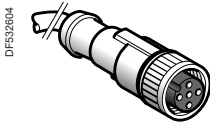

XZCP1141L●

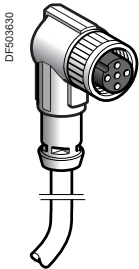

XZCP1241L●

Ø 12 mm, threaded M12 x 1

Sensing distance (Sn) mm	Function	Output	Connection	Reference	Weight kg
Three-wire 12-24V $\overline{\text{DC}}$, flush mountable					
6	NO	PNP	M12	XS912RWPAM12	0.024

Ø 18 mm, threaded M18 x 1

Sensing distance (Sn) mm	Function	Output	Connection	Reference	Weight kg
Three-wire 12-24V $\overline{\text{DC}}$, flush mountable					
10	NO	PNP	M12	XS918RWPAM12	0.051

Connecting cables (PUR) (1)

Description	Type	Length m	Reference	Weight kg
Pre-wired M12 connectors Female, 4-pin Metal clamping ring	Straight	2	XZCP1141L2	0.090
		5	XZCP1141L5	0.190
		10	XZCP1141L10	0.370
	Elbowed	2	XZCP1241L2	0.090
		5	XZCP1241L5	0.190
		10	XZCP1241L10	0.370

Wiring schemes

M12 connector



PNP

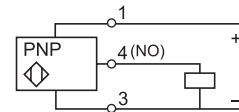

(1) For further information, please consult our site www.teensors.com.

Inductive proximity sensors

XS range, Application
Cylindrical, stainless steel 303 front face
for welding environments
Three-wire DC, solid-state output

Characteristics			
Sensor type	Flush	XS912RWPAM12	XS918RWPAM12
Product certifications		CE, cULus	
Connection	Connector	M12	
Operating zone		mm	0...4.8
Differential travel		%	1...15 (real sensing distance Sr)
Degree of protection	Conforming to IEC 60529	IP 68 (5 meters underwater for 1 month)	
	Conforming to DIN 40050	IP 69K	
Storage temperature		°C	-25...+70 (-13...158°F)
Operating temperature		°C	-25...+70 (-13...158°F)
Materials	Case	Stainless steel, 303 grade	
Front face thickness		mm	0.4
Mechanical shock resistance	Conforming to IEC 62262	IK10	
Vibration resistance	Conforming to IEC 60068-2-6	25 gn, amplitude ± 1 mm (f = 10 to 55 Hz)	
Shock resistance	Conforming to IEC 60068-2-27	30 gn, duration 11 ms	
Output state indication		Yellow LED, 4 viewing points at 90° (blinking from 0.8 Sr and Sr)	
Rated supply voltage		V	--- 12...24 with protection against reverse polarity
Voltage limits (including ripple)		V	--- 10...30
Switching capacity		mA	≤ 200 with overload and short-circuit protection
Voltage drop, closed state		V	≤ 2
Current consumption, no-load		mA	≤ 10
Maximum switching frequency		Hz	15
Delays	First set-up	ms	80
	Response	µs	100
	Recovery	µs	15

Setting-up

Minimum mounting distances in mm, flush version

Side by side

$$\frac{\varnothing 12}{\varnothing 18} \quad \frac{e \geq 38}{e \geq 42}$$

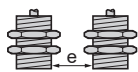

Face to face

$$\frac{e \geq 30}{e \geq 40}$$

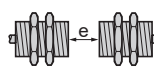

Facing a metal object

$$\frac{e \geq 20}{e \geq 30}$$

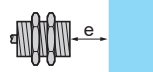

Mounted in a metal support

$$\frac{d \geq 24}{d \geq 50}$$

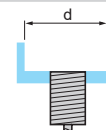

Dimensions

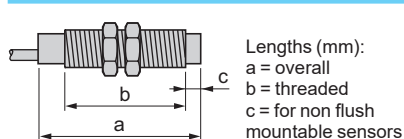

	Flush sensor	
	M12	M18
a (mm)	60	63.5
b (mm)	41	42
c (mm)	0	0

Reduction coefficient

Non flush mounted

	Flush sensor	
	M12	M18
Steel	1	1
Aluminum	1	1
Brass	1.3	1.2
Copper	0.85	0.8
Stainless steel	Thickness 1 mm	0.5
	Thickness 2 mm	0.9

Flush mounted

	Flush sensor	
	M12	M18
Steel	0.7	0.75
Aluminum	1.15	0.9
Brass	1.05	0.75
Stainless steel	0.8	0.8

Flush mountable in metal

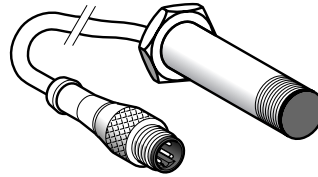
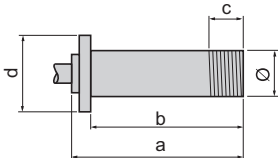

Lengths (mm):
a = Overall
b = To shoulder
c = Removal
d = Shoulder

Ø = 12
a = 55
b = 50
c = 9 (threaded end)
d = 15 hexagonal

Nominal sensing distance (Sn) **3 mm**

References

2-wire $\overline{\text{---}}$ (non polarised) Terminal connections	1-4	NO	XSLC1401393L3
Weight (kg)	0.065		

Characteristics

Connection	Remote M12 connector on 0.8 m flying lead
Degree of protection conforming to IEC 60529	IP 67
Operating zone	0...2.4 mm
Repeat accuracy	≤ 3 % of Sr
Differential travel	1...15 % of Sr
Operating temperature	- 25...+ 80 °C
Output state indication	Yellow LED, annular
Rated supply voltage	$\overline{\text{---}}$ 12...48 V
Voltage limits (including ripple)	$\overline{\text{---}}$ 10...58 V
Switching capacity	1.5...100 mA with overload and short-circuit protection
Voltage drop, closed state	≤ 4 V
Residual current, open state	≤ 0.5 mA
Current consumption, no-load	–
Maximum switching frequency	800 Hz
Delays	First-up: ≤ 5 ms; response: ≤ 05 ms; recovery: ≤ 0.5 ms

Wiring schemes

2-wire $\overline{\text{---}}$, non polarised, NO output

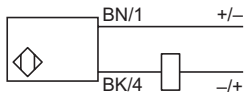

Flush mountable in metal

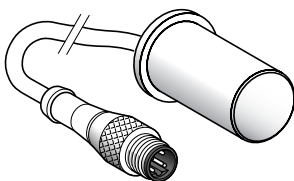

$\varnothing = 18$
 $a = 40$
 $b = 35$
 $c = 0$ (PPS front face)
 $d = \varnothing 22$

Non flush mountable in metal

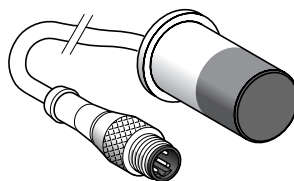

$\varnothing = 18$
 $a = 45$
 $b = 35$
 $c = 20$ (Teflon front face and case)
 $d = \varnothing 22$

6.3 mm

10 mm

10 mm

XSLC1401392L1

XSLC1401405L3

XSLC1401405L4

0.100

0.065

0.050

Remote M12 connector on
1.2 m flying lead

Remote M12 connector on
0.8 m flying lead

Remote M12 connector on
0.15 m flying lead

IP 67

0...5 mm

0...8 mm

3 % of Sr

1...15 % of Sr

-25...+70 °C

Yellow LED, annular

~ 12...48 V

~ 10...58 V

1.5...100 mA with overload and short-circuit protection

≤ 4 V

≤ 0.5 mA

-

100 Hz

First-up: ≤ 10 ms; response: ≤ 10 ms; recovery: ≤ 2 ms

Setting-up

Minimum mounting distances (mm)

Side by side

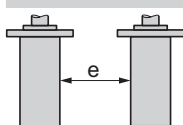

Face to face

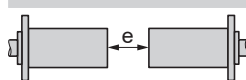

Facing a metal object

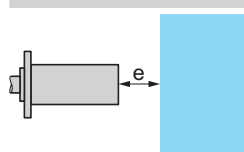

Mounted in a metal support

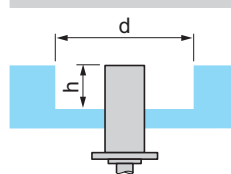

XSLC $\varnothing 12$ (flush mountable)

$e \geq 10$

$e \geq 60$

$e \geq 15$

$d = 12, h = 0$

$\varnothing 18$ (non flush mountable)

$e \geq 16$

$e \geq 96$

$e \geq 24$

$d = 54, h = 16$

Inductive proximity sensors

XS range

Detection at fixed sensing distance. Factor 1 (Fe/Nfe) sensors ⁽¹⁾ for ferrous and non ferrous materials
Solid-state output

Flush mountable in metal

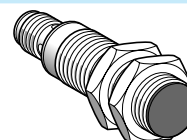
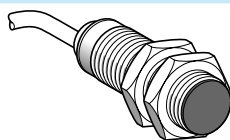
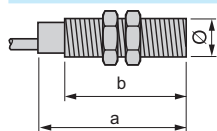

Lengths (mm):
a = Overall
b = Threaded section

a = 60
b = 51.5
Ø = M18 x 1

a = 70
b = 51.5
Ø = M18 x 1

	Brass case	Brass case
Nominal sensing distance (Sn)	5 mm	5 mm

References

4-wire ☐	PNP/PNP programmable NO/NC	XS1M18KPM40	XS1M18KPM40D
Weight (kg)		0.120	0.060

Characteristics

Product certifications	CE, UL, CSA		
Connection	Pre-cabled, PvR 4 x 0.34 mm ² , length 2 m ⁽²⁾		M12 connector
Degree of protection	Conforming to IEC 60529	IP 68	IP 67
Operating zone	0...4 mm		
Repeat accuracy	3 % of Sr		
Differential travel	1...15 % of Sr		
Operating temperature	0...+ 50 °C		
Output state indication	Yellow LED, annular		Yellow LED, 4 viewing ports at 90°
Rated supply voltage	☐ 12...24 V with protection against reverse polarity		
Voltage limits (including ripple)	☐ 10...38 V		
Switching capacity	0...200 mA with overload and short-circuit protection		
Voltage drop, closed state	≤ 2.6 V		
Current consumption, no-load	≤ 15 mA		
Maximum switching frequency	1000 Hz		
Delays	First-up	≤ 10 ms	
	Response	≤ 0.3 ms	
	Recovery	≤ 0.7 ms	

Wiring schemes

M12 connector	Pre-cabled	4-wire ☐, PNP/NPN, NO or NC output	
	BN: brown BU: blue BK: black WH: white	PNP 	NPN

⁽¹⁾ The variation in sensing distance between ferrous and non ferrous materials is typically less than 5 %.
⁽²⁾ Sensors available with other cable lengths: please consult our Customer Care Centre.

Inductive proximity sensors

XS range

Detection at fixed sensing distance. Factor 1 (Fe/Nfe) sensors ⁽¹⁾ for ferrous and non ferrous materials
Solid-state output

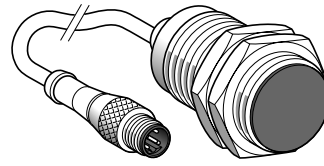
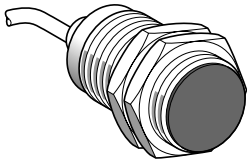

a = 60
b = 51.5
Ø = M30 x 1.5

a = 60
b = 51.5
Ø = M30 x 1.5

Stainless steel case	Stainless steel case
10 mm	10 mm

References	
XS1M30KPM40	XS1M30KPM40LD
0.205	0.145

Characteristics	
C€, UL, CSA	
Pre-cabled, PvR 4 x 0.34 mm ² , length 2 m ⁽²⁾	M12 connector on 0.8 m flying lead
IP 68	IP 67
0...8 mm	
3 % of Sr	
1...15 % of Sr	
0...+ 50 °C	
Yellow LED, annular	
--- 12...24 V with protection against reverse polarity	
--- 10...38 V	
0...200 mA with overload and short-circuit protection	
≤ 2.6 V	
≤ 15 mA	
1000 Hz	
≤ 5 ms	
≤ 0.3 ms	
≤ 0.7 ms	

Setting-up				
Minimum mounting distances (mm)	Side by side	Face to face	Facing a metal object	Mounted in a metal support

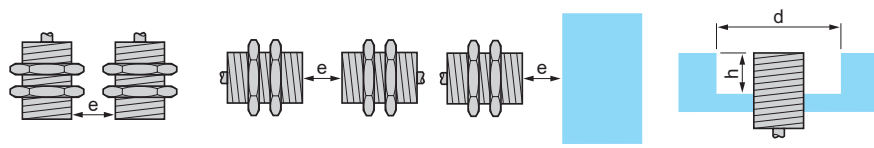

XS1M18 flush mountable	e ≥ 10	e ≥ 60	e ≥ 15	d ≥ 18, h ≥ 0
XS1M30 flush mountable	e ≥ 20	e ≥ 120	e ≥ 30	d ≥ 30, h ≥ 0

Fixing nut tightening torque: **XS1M18**: < 35 N.m, **XS1M30**: < 100 N.m

⁽¹⁾ The variation in sensing distance between ferrous and non ferrous materials is typically less than 5 %.
⁽²⁾ Sensors available with other cable lengths: please consult our Customer Care Centre.

Inductive proximity sensors

XS range, Application

Factor 1 sensors for ferrous or non ferrous material detection and welding applications. Plastic case, 40 x 40 mm front face. 5 position turret head

Sensor	Flush mountable in metal	
Dimensions	40 x 40 x 70 mm	40 x 40 x 117 mm

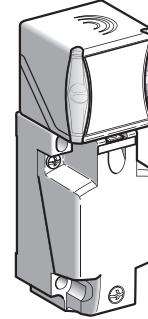
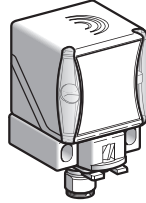

Nominal sensing distance (Sn)	20 mm
--------------------------------------	-------

References

4-wire ☐☐☐	PNP NO+NC	XS9C2A1PCM12	XS9C4A1PCP20 (1)
	NPN NO+NC	XS9C2A1NCM12	XS9C4A1NCP20 (1)

XS9C4●●●P20 sensors are available with an ISO M20 cable entry and can be supplied with a Pg 13.5 (e.g. **XS9C4A1PCG13**) or a 1/2" NPT (e.g. **XS9C4A1PCN12**) cable entry: please consult our Customer Care Centre for more information.

Weight (kg)	0.110	0.220
--------------------	-------	-------

Characteristics

Product certifications	UL, CSA, CE	
Conformity to standards	IEC 60947-5-2	
Connection	M12 connector (4-pin)	Screw terminals, clamping capacity 4 x 1.5 mm ² / 4 x 16 AWG
Operating zone	0...16 mm	
Differential travel	3...15% of Sr	
Repeat accuracy	< 3%	
Immunity to magnetic fields	< 250 mTesla	
Degree of protection	Conforming to IEC 60529 and DIN 40050	IP 65, IP 67 and IP 69K
Temperature	Storage	- 40...+ 85°C
	Operation (2)	- 25...+ 70°C
Material	Case: PBT	
Vibration resistance	Conforming to IEC 60068-2-6	25 gn, amplitude ± 2 mm (f = 10...55 Hz)
Shock resistance	Conforming to IEC 60068-2-27	50 gn for 11 ms
Indicators	Output state: yellow LED. Supply on: green LED	
Rated supply voltage	4-wire ☐☐☐	☐☐☐ 12...24 V with protection against reverse polarity
Voltage limits (including ripple)	4-wire ☐☐☐	☐☐☐ 10...36 V
Current consumption, no-load	4-wire ☐☐☐	< 30 mA
Switching capacity	4-wire ☐☐☐	< 200 mA with protection against overload and short-circuit
Voltage drop, closed state	4-wire ☐☐☐	< 2 V
Maximum switching frequency	4-wire ☐☐☐	250 Hz
Delays	First-up	< 15 ms
	Response	< 2.5 ms
	Recovery	< 2.5 ms

Setting-up

Sensing distance correction factor

SS: stainless steel, Fe: steel, Al: aluminium, Cu: copper.

Operating distance (according to the sensor's level of flush mounting)

--- : Flush mounted in Fe360 — : Flush mounted in aluminium

(1) These sensors are supplied without a cable gland. A suitable Pg 13.5 cable gland is available (reference **XSZPE13**).
 (2) Sensors are available for very low temperatures (suffix **TF**: - 40°C, + 70°C) or very high temperatures (suffix **TT**: - 25°C, + 85°C); please consult our Customer Care Centre.

Inductive proximity sensors

XS range, Application

Factor 1 sensors for ferrous or non ferrous material detection and welding applications. Plastic case, 40 x 40 mm front face. 5 position turret head

Setting-up (continued)

Minimum mounting distances (mm)



Side by side

Face to face

Facing a metal object

Sensors flush mountable in metal

$e \geq 80$

$e \geq 200$

$e \geq 60$

Wiring schemes

M12 connector



1: + V
2: NC Output
3: 0 V
4: NO Output

4-wire \overline{N} , NO + NC outputs

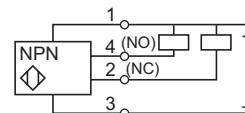
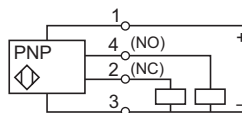

Accessories

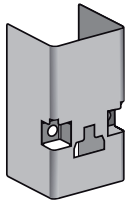

XSZPSC2

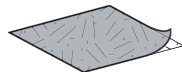

XSZPKC2

Description	Use for	Reference	Weight kg
Stainless steel rigid protective cover (only suitable for use when detecting from the top)	Welding	XSZPSC2	0.010
Protective sheet (for sensing face of sensor)	Welding	XSZPKC2	0.010

[Sold in lots of 5](#)

Dimensions

XS9C2A1PCM12 and XS9C2A1NCM12

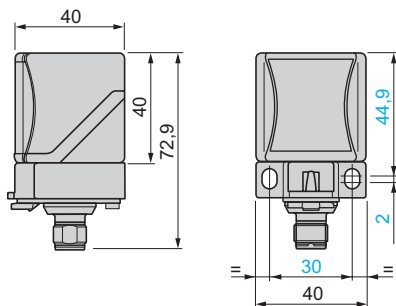

Head positions

XS9C2A1PCM12 and XS9C2A1NCM12

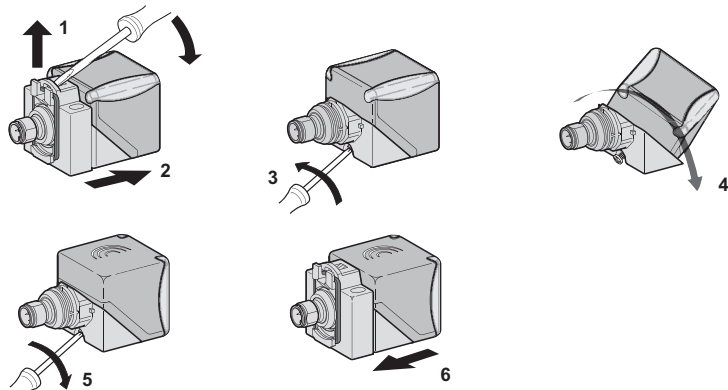

XS9C4A1PCP20 and XS9C4A1NCP20

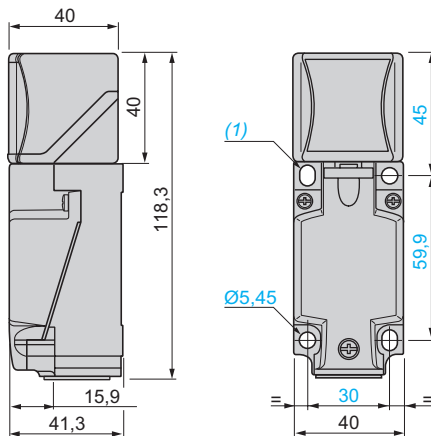

XS9C4A1PCP20 and XS9C4A1NCP20

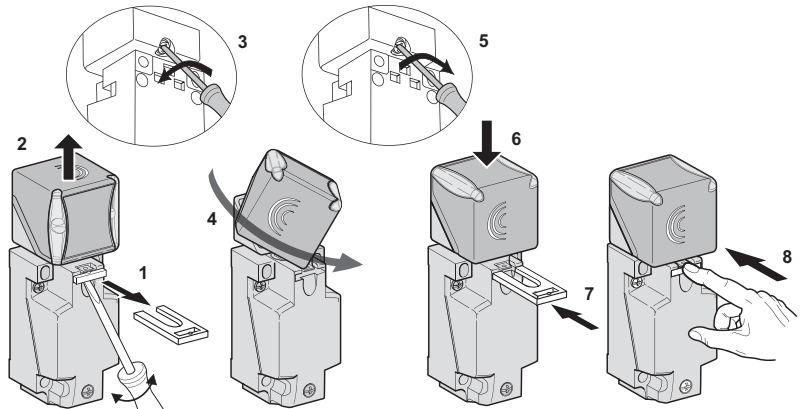

(1) 2 elongated holes $\varnothing 5.3 \times 7$ mm.

Tightening torque of cover fixing screws and clamp screws: $< 1.2 \text{ N.m} / < 10.62 \text{ lb-in}$.

Inductive proximity sensors

XS range, Application

Selective detection of ferrous materials

Selective detection of non ferrous materials

Cylindrical type, solid-state output

Flush mountable

Stainless steel case

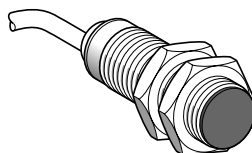

Nominal sensing distance (Sn) 5 mm

References

3-wire, ferrous version Insensitive to non ferrous materials	PNP NO	XS1M18PAS40
3-wire, non ferrous version Insensitive to ferrous materials	PNP NO	XS1M18PAS20
Weight (kg)		0.120

Characteristics

Product certifications	UL, CSA, CE
Connection	Pre-cabled, PvR, 3 x 0.34 mm ² , length 2 m (1)
Operating zone	0...4 mm
Degree of protection conforming to IEC 60529	IP 68
Operating temperature	-25...+70 °C
Output state indication	Yellow LED, annular
Rated supply voltage	DC 12...24 V with protection against reverse polarity
Voltage limits (including ripple)	DC 10...38 V
Switching capacity	0...200 mA with overload and short-circuit protection
Voltage drop, closed state	≤ 2.6 V
Residual current, open state	–
Current consumption, no-load	≤ 15 mA
Maximum switching frequency	1000 Hz
Delays	First-up ≤ 10 ms Response ≤ 0.3 ms Recovery ≤ 0.7 ms

(1) Sensors available with other cable lengths: please consult our Customer Care Centre.

Wiring schemes

3-wire DC PNP

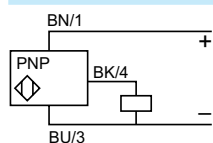

Dimensions

XS1M

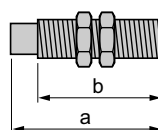

a (mm)	b (mm)
60	51.5

Setting-up

Minimum mounting distances (mm)

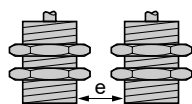

Side by side

$e \geq 10$

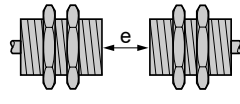

Face to face

$e \geq 60$

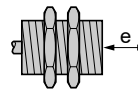

Facing a metal object

$e \geq 15$

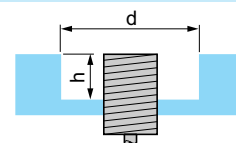

Mounted in a metal support

$d \geq 18, h \geq 0$ (ferrous metal)

$d \geq 18, h \geq 5$ (non ferrous metal)

Inductive proximity sensors

XS range, Application

Selective detection of ferrous materials

Selective detection of non ferrous materials

Cylindrical type, solid-state output

Flush mountable

Stainless steel case

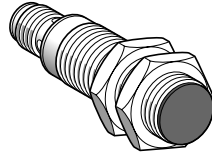

Nominal sensing distance (Sn) 5 mm

References

3-wire, ferrous version Insensitive to non ferrous materials	PNP NO	XS1M18PAS40D
3-wire, non ferrous version Insensitive to ferrous materials	PNP NO	XS1M18PAS20D
Weight (kg)		0.060

Characteristics

Product certifications	UL, CSA, CE
Connection	M12 connector
Degree of protection conforming to IEC 60529	IP 67
Operating zone	0...4 mm
Operating temperature	-25...+70 °C
Output state indication	Yellow LED, 4 viewing ports at 90°
Rated supply voltage	12...24 V with protection against reverse polarity
Voltage limits (including ripple)	10...38 V
Switching capacity	0...200 mA with overload and short-circuit protection
Voltage drop, closed state	≤ 2.6 V
Residual current, open state	–
Current consumption, no-load	≤ 15 mA
Maximum switching frequency	1000 Hz
Delays	
First-up	≤ 10 ms
Response	≤ 0.3 ms
Recovery	≤ 0.7 ms

Wiring schemes

M12 connector

3-wire PNP

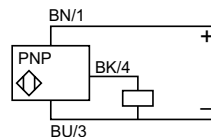

Dimensions

XS1M

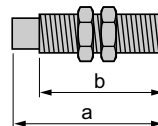

a (mm)	b (mm)
70	51.5

Setting-up

Minimum mounting distances (mm)

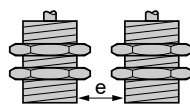

Side by side

$e \geq 10$

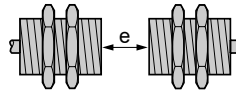

Face to face

$e \geq 60$

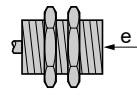

Facing a metal object

$e \geq 15$

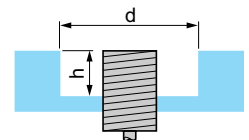

Mounted in a metal support

$d \geq 18, h \geq 0$ (ferrous metal)

$d \geq 18, h \geq 5$ (non ferrous metal)

XS1M18

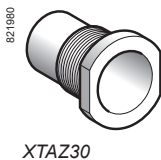
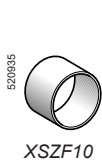
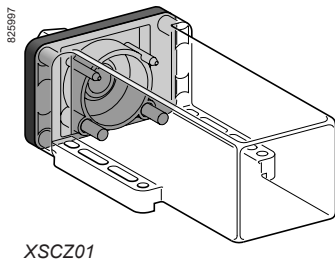
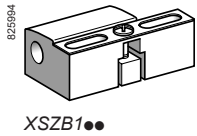
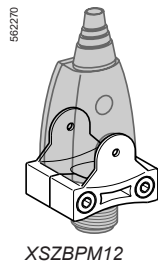
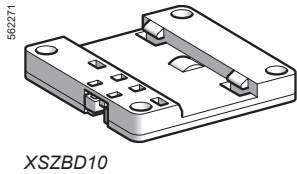
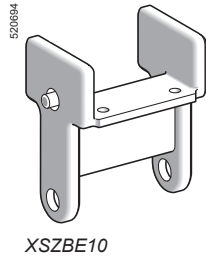
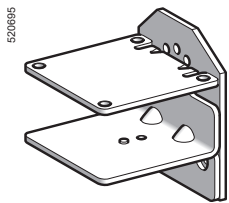
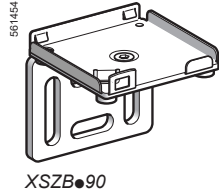
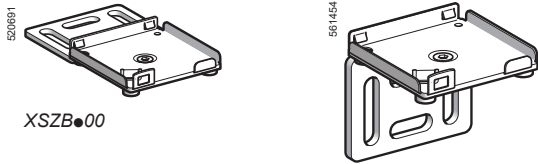

Mounting and fixing accessories

Description	For use with sensor		Unit reference	Weight kg	
	Type	Diameter (mm)			
"Clip" mounting plate Can be mounted without "clip" on threaded holes	XS●J	–	XSZBJ00	0.003	
	XS●F	–	XSZBF00	0.005	
	XS●E	–	XSZBE00	0.025	
	XS●C	–	XSZBC00	0.060	
"Clip" 90° mounting bracket Can be mounted without "clip" on threaded holes	XS●J	–	XSZBJ90	0.003	
	XS●F	–	XSZBF90	0.005	
	XS●E	–	XSZBE90	0.025	
Replacement bracket	XS●C	–	XSZBC90	0.060	
	XS●E	–	XSZBE10	0.060	
	XS●C	–	XSZBC10	0.110	
	XS●D (for XSD) (1)	–	XSZBD10	0.065	
Fixing clamp for remote control	XS9, XS6●●●B2	–	XSZBPM12	0.015	
Fixing clamps	XS1	4 (plain)	XSZB104	0.005	
		5 (M5 x 0.5)	XSZB105	0.005	
	XS1, XS2	6.5 (plain)	XSZB165	0.005	
	XS1, XS2, XS4, XS5, XS6	8 (M8 x 1)	XSZB108	0.006	
	XS1, XS2, XS4, XS5, XS6, XT1	12 (M12 x 1)	XSZB112	0.006	
		18 (M18 x 1)	XSZB118	0.010	
		30 (M30 x 1.5)	XSZB130	0.020	
	XT1	32 (plain)	XUZB32	0.050	
	Set of 2 metal fixing nuts, nickel plated	XS1	5 (M5 x 0.5)	XSZE105	0.010
		XS1, XS2, XS5, XS6	8 (M8 x 1)	XSZE108	0.015
XS1, XS2, XT1, XS5, XS6		12 (M12 x 1)	XSZE112	0.015	
		18 (M18 x 1)	XSZE118	0.020	
		30 (M30 x 1.5)	XSZE130	0.050	
Set of 2 stainless steel fixing nuts	XS1, XS2, XS5, XS6	8 (M8 x 1)	XSZE308	0.015	
	XS1, XS2, XT1, XS5, XS6	12 (M12 x 1)	XSZE312	0.015	
		18 (M18 x 1)	XSZE318	0.020	
		30 (M30 x 1.5)	XSZE330	0.050	
Set of 2 plastic fixing nuts	XS4	8 (M8 x 1)	XSZE208	0.002	
		12 (M12 x 1)	XSZE212	0.003	
	XS4	18 (M18 x 1)	XSZE218	0.004	
Adaptor collar	∅ 20	XS●, XT●	XSZA020	0.005	
	∅ 34	XS●, XT●	XSZA034	0.005	
		30 (M30 x 1.5)	XSZA034	0.005	

Protection accessories

Cable sleeve adaptor (CNOMO type)	XS●, XT●	12 (M12 x 1)	XSZP112	0.005
		18 (M18 x 1)	XSZP118	0.005
		30 (M30 x 1.5)	XSZP130	0.010
Outer cover (IP 68)	XT7, XS7, XS8 and XS9 –	–	XSCZ01	0.100
Thread adaptor	XS●, XT●	30 (M30 x 1.5)	XTAZ30	0.035
13P cable gland	Clamping capacity ∅ 9 to 12 mm	–	XSZPE13	0.010
Protective cover	M12 universal connectors	–	XSZF10	0.020

Sold in lots of 50

Fuses (for unprotected 2-wire ~/~ sensors)

Description	Type	Sold in lots of	Unit reference	Weight kg
Cartridge fuses 5 x 20	0.4 A "quick-blow"	10	XUZE04	0.001
	0.63 A "quick-blow"	10	XUZE06	0.001
	0.8 A "quick-blow"	10	XUZE08	0.001
Fuse terminal block for XUZE0●		50	AB1FU10135U	0.040

(1) Depth adjustment shim for converting 80 x 80 x 26 mm format to 80 x 80 x 40 mm format. Also enables clipping onto 35 mm omega rail.

XSZBJ00

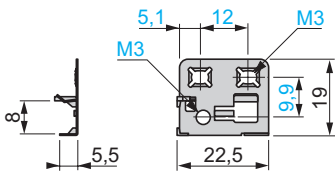

XSZBF00

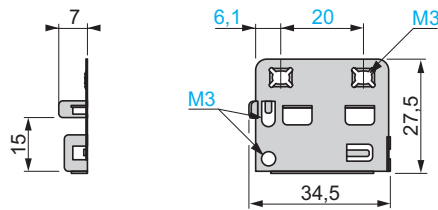

XSZBE00

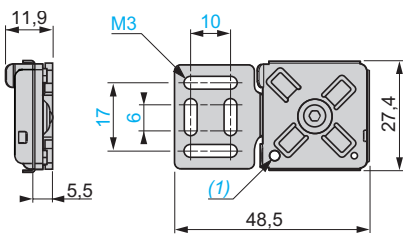

XSZBC00

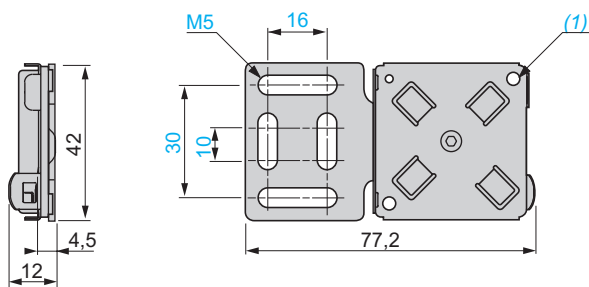

(1) 2 screws M3 x 12 (included).

(1) 4 screws M4 x 14 (included).

XSZBJ90

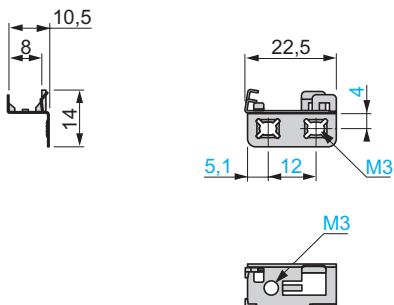

XSZBF90

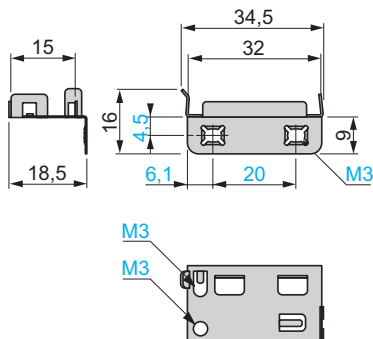

XSZBE90

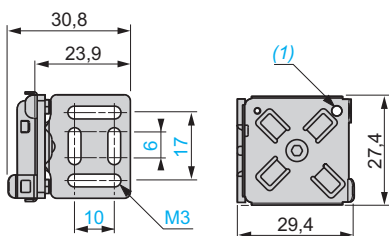

XSZBC90

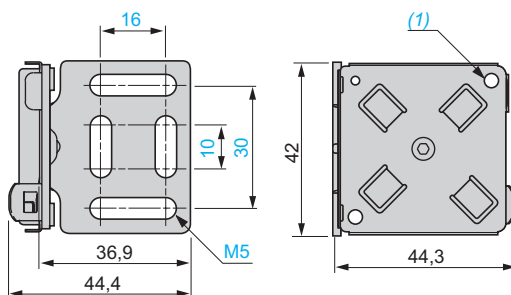

(1) 2 screws M3 x 12 (included).

(1) 4 screws M4 x 14 (included).

XSZBE10

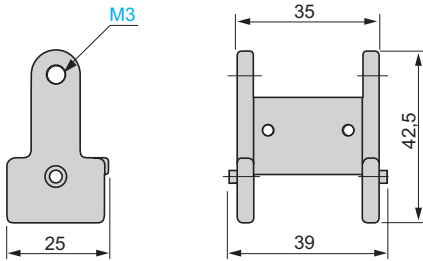

XSZBC10

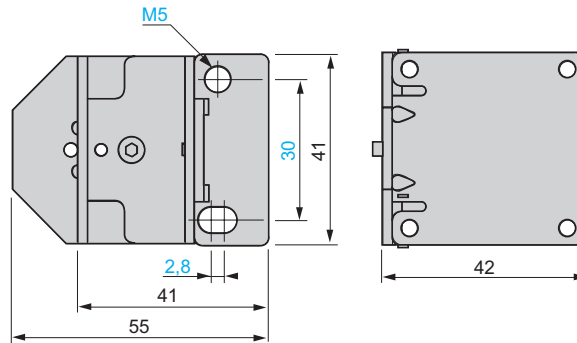

XSZBD10 (for mounting on XS0D0000)

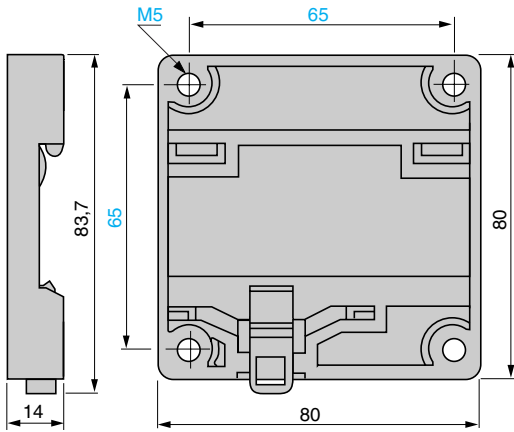

XSZBPM12

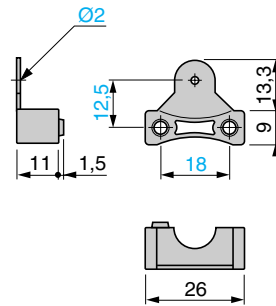

XSZB104, XSZB105

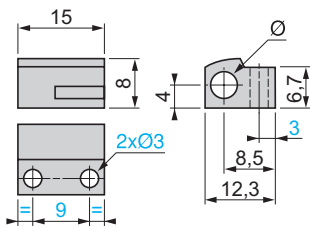

XSZB108, XSZB112, XSZB118, XSZB130, XSZB165

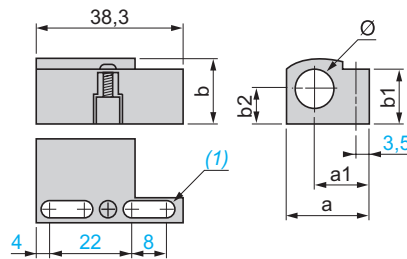

XSZ	a	a1	b	b1	b2	Ø
B108	19.9	14.5	14	12.5	7.5	8
B112	21.9	14.5	16	15.5	8.5	12
B118	26	15.7	22.3	20.1	11.5	18
B130	39	21.7	35.5	31	18.5	30
B165	19.9	14.5	14	12.5	7.5	6.5

(1) 2 elongated holes 4 x 8 mm.

XSZ	Ø
B104	4
B105	5

Note: for fixing clamps XSZB118 and XSZB130, see mounting precautions, page 19.

XUZB32

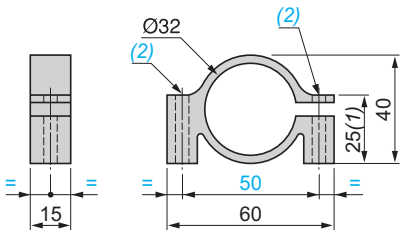

(1) Maximum value

(2) 2 holes $\varnothing 5.5$

2 x M5 screws, HM head, included with fixing clamp

XSZA0●●

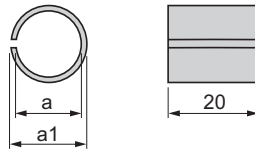

XSZ	a	a1
A020	$\varnothing 18$	$\varnothing 20$
A034	$\varnothing 30$	$\varnothing 34$

XSZP112, XSZP118, XSZP130

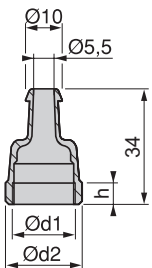

XSZ	h	$\varnothing d1$	$\varnothing d2$
P112	7	12	16,8
P118	6,2	18	23
P130	6,2	30	34,4

XSCZ01

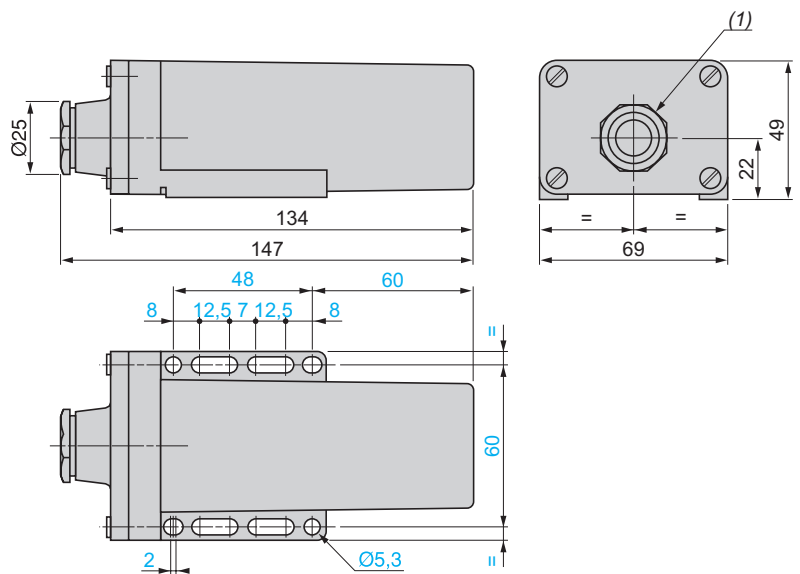

XTAZ30

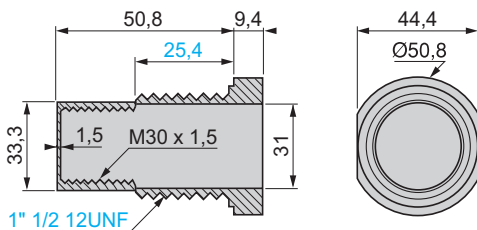

(1) 13P cable gland

Cylindrical type sensors

Flush mountable in metal

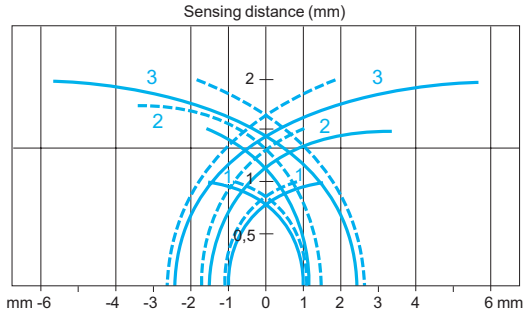

Sensor (mm)	Standard steel target (mm)	Operating zone (mm)
Ø 4	5 x 5 x 1	0...0.8
Ø 5	5 x 5 x 1	0...0.8
Ø 6.5	8 x 8 x 1	0...1.2
Ø 8	8 x 8 x 1	0...1.2
Ø 12	12 x 12 x 1	0...1.6

— pick-up points
 - - - drop-out points (object approaching from the side)
 1 Ø 4 (plain) XS1 and Ø 5 (M5 x 0.5) XS1
 2 Ø 6.5 (plain) XS1 and Ø 8 (M8 x 1) XS5
 3 Ø 12 (M12 x 1) XS5

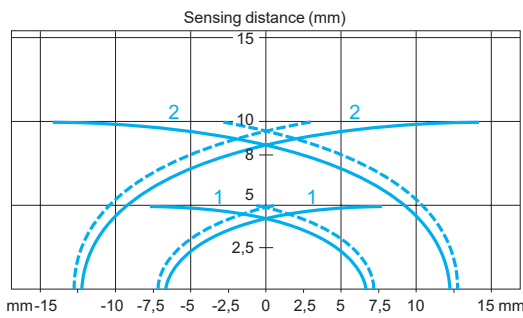

Sensor (mm)	Standard steel target (mm)	Operating zone (mm)
Ø 18	18 x 18 x 1	0...4
Ø 30	30 x 30 x 1	0...8

— pick-up points
 - - - drop-out points (object approaching from the side)
 1 Ø 18 (M18 x 1) XS5
 2 Ø 30 (M30 x 1.5) XS5

Non flush mountable in metal

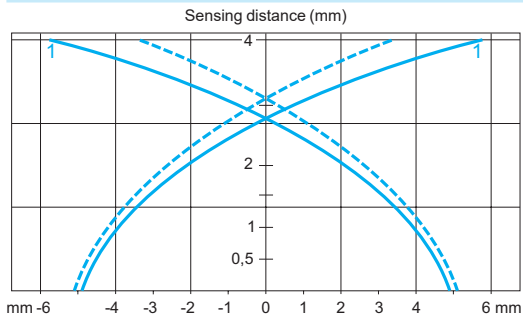

Sensor (mm)	Standard steel target (mm)	Operating zone (mm)
Ø 12	12 x 12 x 1	0...3.2

— pick-up points
 - - - drop-out points (object approaching from the side)
 1 Ø 12 (M12 x 1) XS4

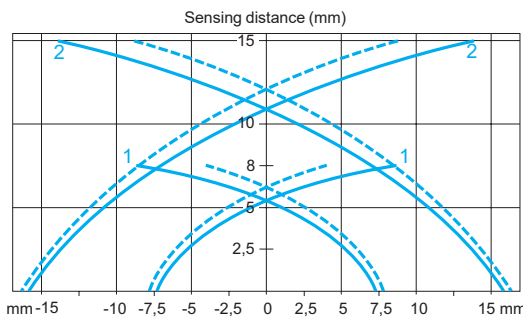

Sensor (mm)	Standard steel target (mm)	Operating zone (mm)
Ø 18	24 x 24 x 1	0...6.4
Ø 30	45 x 45 x 1	0...12

— pick-up points
 - - - drop-out points (object approaching from the side)
 1 Ø 18 (M18 x 1) XS4
 2 Ø 30 (M30 x 1.5) XS4

Cylindrical type sensors, increased range

Flush mountable in metal

Non flush mountable in metal

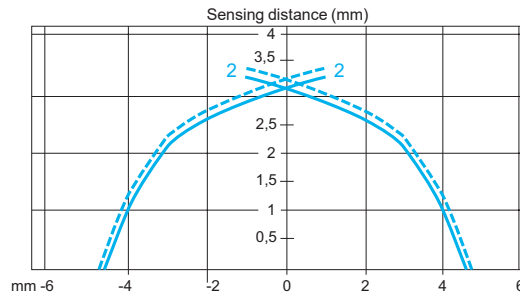
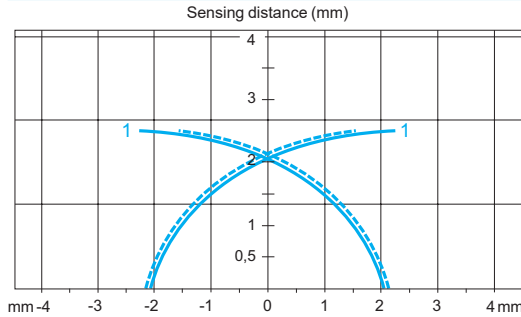

Sensor (mm)

Ø 6,5 and Ø 8

Standard steel target (mm)

8 x 8 x 1

Operating zone (mm)

0...2 (flush mounted)
0...3.2 (not flush mounted)

1 Ø 6.5 (plain) XS106B3●●
and Ø 8 (M8 x 1) XS108B3
and XS608B1
2 XS608B4

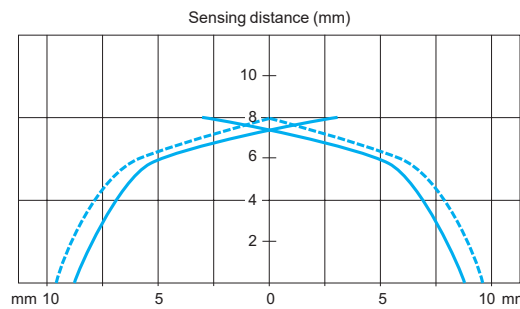
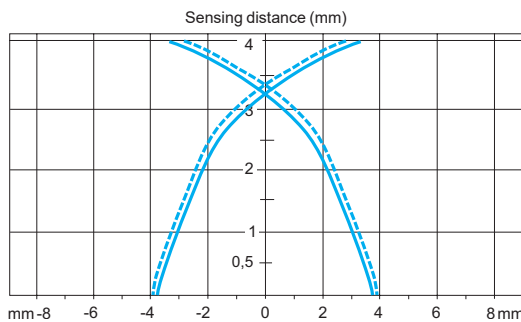

Sensor (mm)

Ø 12

Standard steel target (mm)

12 x 12 x 1

Operating zone (mm)

0...3.2 (flush mounted)
0...6.4 (not flush mounted)

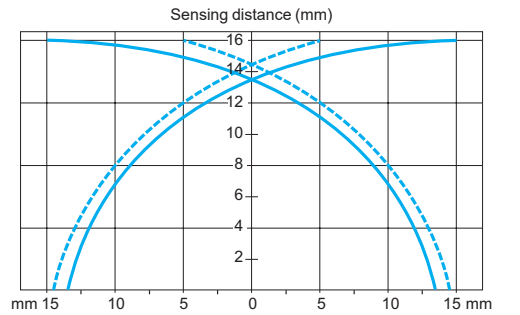
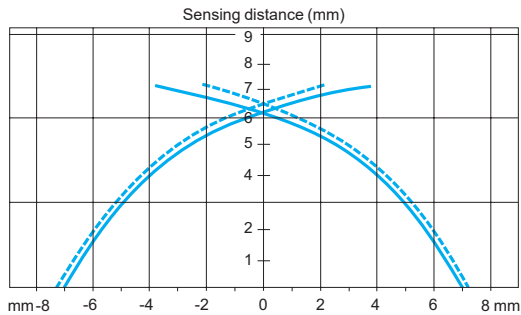

Sensor (mm)

Ø 18

Standard steel target (mm)

24 x 24 x 1

Operating zone (mm)

0...6.4 (flush mounted)
0...12.8 (not flush mounted)

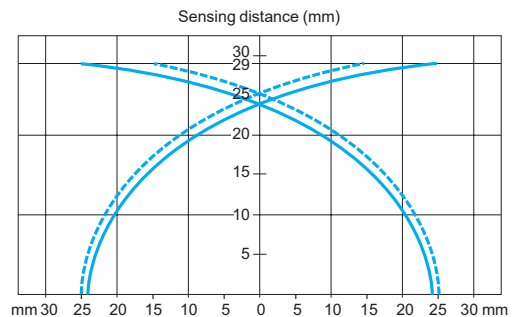
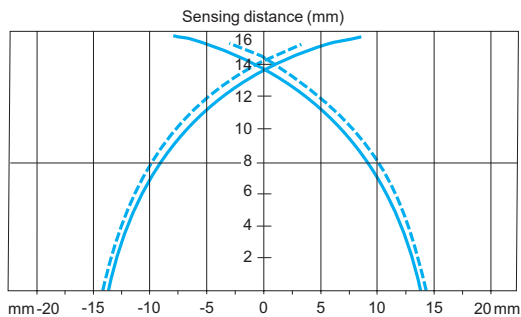

Sensor (mm)

Ø 30

Standard steel target (mm)

45 x 45 x 1

Operating zone (mm)

0...12 (flush mounted)
0...24 (not flush mounted)

— pick-up points
- - - drop-out points (object approaching from the side)

Cubic, flat or rectangular type sensors

Flush mountable in metal

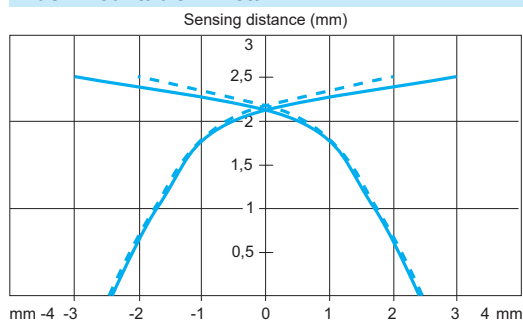

Sensor	Standard steel target (mm)	Operating zone (mm)
XS7J1A1	5 x 5 x 1	0...2

— pick-up points
- - - drop-out points (object approaching from the side)

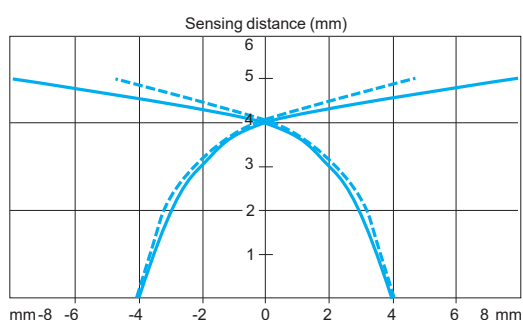

Sensor	Standard steel target (mm)	Operating zone (mm)
XS7F1A1	5 x 5 x 1	0...4

— pick-up points
- - - drop-out points (object approaching from the side)

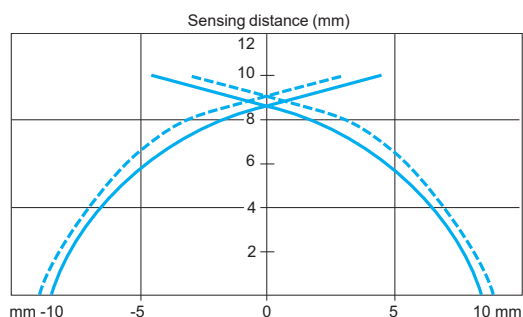

Sensor	Standard steel target (mm)	Operating zone (mm)
XS7E1A1	8 x 8 x 1	0...8

— pick-up points
- - - drop-out points (object approaching from the side)

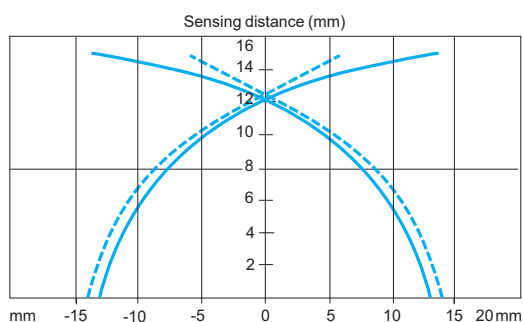

Sensor	Standard steel target (mm)	Operating zone (mm)
XS7C1A1 XS7C2A1	18 x 18 x 1	0...12

— pick-up points
- - - drop-out points (object approaching from the side)

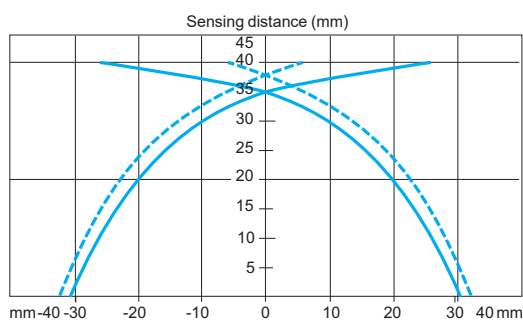

Sensor	Standard steel target (mm)	Operating zone (mm)
XS7D1A1	30 x 30 x 1	0...32

— pick-up points
- - - drop-out points (object approaching from the side)

Cubic or rectangular type sensors, increased range

Flush mountable in metal

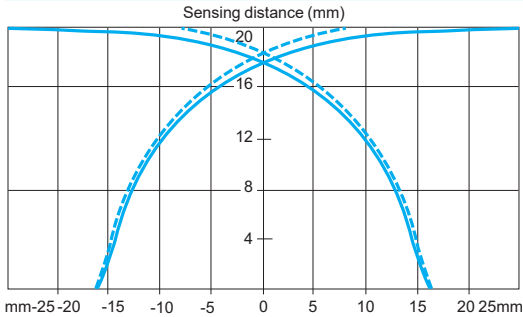

Sensor	Standard steel target (mm)	Operating zone (mm)
XS8C●A1●	30 x 30 x 1	0...16
— pick-up points - - - drop-out points (object approaching from the side)		

Non flush mountable in metal

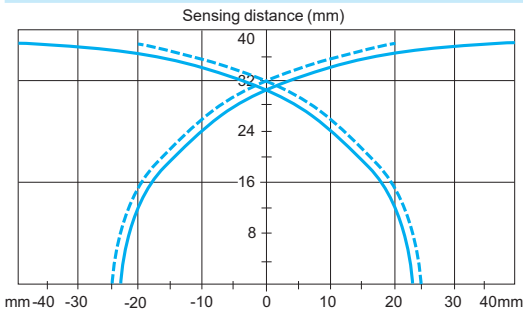

Sensor	Standard steel target (mm)	Operating zone (mm)
XS8C●A4●	45 x 45 x 1	0...32
— pick-up points - - - drop-out points (object approaching from the side)		

Flat type sensors, increased range

Flush mountable in metal

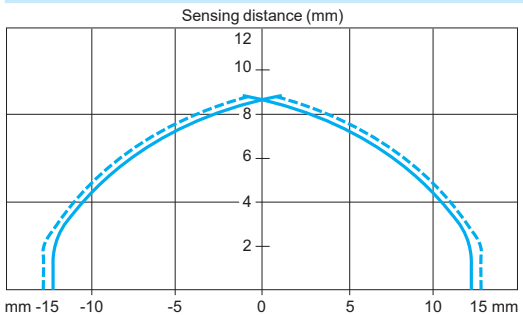

Non flush mountable in metal

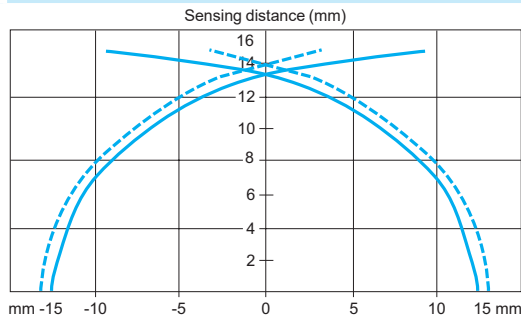

Sensor
XS8E
Standard steel target (mm)
18 x 18 x 1
Operating zone (mm)
5...10 (flush mounted) 5...15 (not flush mounted)

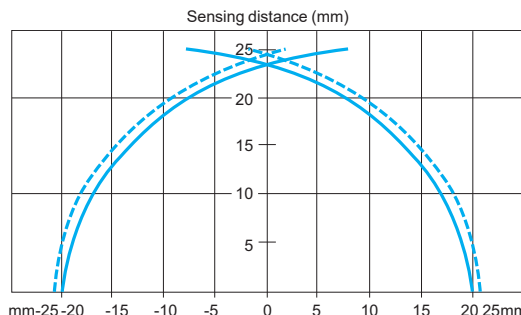
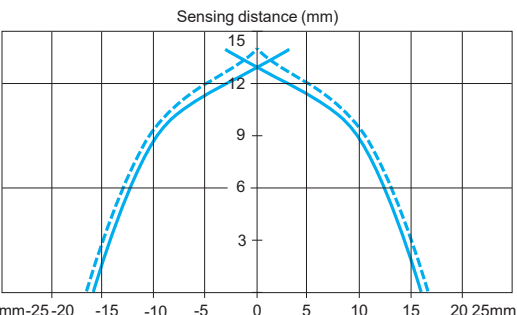

Sensor
XS8C
Standard steel target (mm)
30 x 30 x 1
Operating zone (mm)
8...15 (flush mounted) 8...25 (not flush mounted)

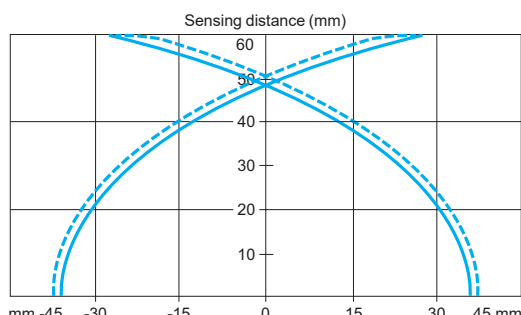
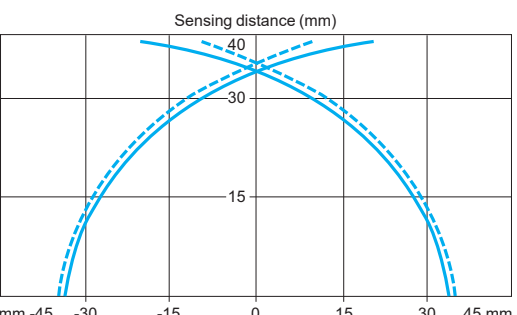

Sensor
XS8D
Standard steel target (mm)
45 x 45 x 1
Operating zone (mm)
20...40 (flush mounted) 0...60 (not flush mounted)

— pick-up points
 - - - drop-out points (object approaching from the side)

Substitution table

Sensors with the closest functionalities

Inductive proximity sensors

Old sensor	New XS sensor	Old sensor	New XS sensor	Old sensor	New XS sensor
Cylindrical type, DC (continued)					
Diameter 12 mm					
XS1					
XS1M12DA210	XS512B1DAL2	XS1N12PA340S	XS512B1PAM12 (2)	XS2N12PC410D	XS112B3PCM12
XS1M12DA210D	XS512B1DAM12	XS1N12PB340	XS512B1PBL2	XS2N12PC410L1	XS112B3PCM12 + XZCPV1141L5
XS1M12DA210L1	XS512B1DAL5	XS1N12PB340D	XS512B1PBM12	XS2N12PC410L2	XS112B3PCM12 + XZCPV1141L10
XS1M12DA210L2	XS512B1DAL10	XS1N12PB340L1	XS512B1PBL5	XS2N12PB340	XS112B3PBL2
XS1M12DA210LA	XS512B1DAL08U78			XS2N12PB340D	XS112B3PBM12
XS1M12DA210LD	XS512B1DAL08M12	XS1M12PA349D	XS612B1PAM12	XS2N12PB340L1	XS112B3PBL5
XS1M12DB210	XS512B1DBL2	XS1N12NA349D	XS112B3NAL2		
XS1M12DB210D	XS512B1DBM12	XS1N12NA349L1	XS112B3NAL5	XS3	
XS1M12DB210L1	XS512B1DBL5	XS1N12NA349D	XS112B3NAM12	XS3P12NA340	XS512B1NAL2 (3)
XS1M12DB210L2	XS512B1DBL10	XS1N12NB349	XS112B3NBL2	XS3P12NA340D	XS512B1NAM12 (3)
XS1M12DB210LD	XS512B1DBL08M12	XS1N12NB349L1	XS112B3NBL5	XS3P12NA340L1	XS512B1NAL5 (3)
		XS1N12NB349D	XS112B3NBM12	XS3P12PA340	XS512B1PAL2 (3)
		XS1N12PA349	XS112B3PAL2	XS3P12PA340D	XS512B1PAM12 (3)
XS1M12DA214D	XS512B1CAM12	XS1N12PA349L1	XS112B3PAL5	XS3P12PA340L1	XS512B1PAL5 (3)
XS1M12DA214LD	XS512B1CAL08M12	XS1N12PB349	XS112B3PAM12		
		XS1N12PB349L1	XS112B3PBL2	XS3P12NA370	XS512BLNAL2 (3)
		XS1N12PB349D	XS112B3PBL5	XS3P12NA370L1	XS512BLNAL5 (3)
			XS112B3PBM12	XS3P12PA370	XS512BLPAL2 (3)
				XS3P12PA370L1	XS512BLPAL5 (3)
XS1M12NA370	XS512BLNAL2	XS2			
XS1M12NA370D	XS512BLNAM12	XS2M12NA370	XS612B1NAL2		
XS1M12NA370L1	XS512BLNAL5	XS2M12NA370D	XS612B1NAM12		
XS1M12NA370L2	XS512BLNAL10	XS2M12NA370L1	XS612B1NAL5		
XS1M12NA370S	XS612B1NAM12 (2)	XS2M12NA370L2	XS612B1NAL10		
XS1M12NB370	XS512BLNBL2	XS2M12NB370	XS612B1NBL2		
XS1M12NB370D	XS512BLNBM12	XS2M12NB370D	XS612B1NBL5		
XS1M12PA370	XS512BLPAL2	XS2M12PA370	XS612B1PAL2		
XS1M12PA370D	XS512BLPAM12	XS2M12PA370L1	XS612B1PAL5		
XS1M12PA370L1	XS512BLPAL5	XS2M12PA370L2	XS612B1PAL10		
XS1M12PA370L2	XS512BLPAL10	XS2M12PA370LA	XS612B1PAL08U78		
XS1M12PA370LA	XS612B1PAL08U78	XS2M12PA370LD	XS612B1PAL08M12		
XS1M12PA370LD	XS612B1PAL08M12	XS2M12PB370	XS612B1PBL2		
XS1M12PB370	XS512BLPBL2	XS2M12PB370D	XS612B1PBL5		
XS1M12PB370D	XS512BLPBM12	XS2M12PB370L1	XS612B1PBL10		
XS1M12PB370L1	XS512BLPBL5	XS2M12PB370S	XS612B1PBM12 (2)		
XS1M12PB370L2	XS512BLPBL10				
XS1M12PB370LD	XS612B1PAM12 (1)				
XS1N12NA340	XS512B1NAL2	XS2N12NA340	XS112B3NAL2		
XS1N12NA340D	XS512B1NAM12	XS2N12NA340D	XS112B3NAM12		
XS1N12NA340L1	XS512B1NAL5	XS2N12NA340L1	XS112B3NAL5		
XS1N12NA340L2	XS512B1NAL10	XS2N12NA340L2	XS112B3NAL10		
XS1N12NB340	XS512B1NBL2	XS2N12NB340	XS112B3NBL2		
XS1N12NB340D	XS512B1NBM12	XS2N12NB340D	XS112B3NBM12		
XS1N12NC410L2	XS1N12NC410D + XZCPV1141L10	XS2N12NC410L1	XS2N12NC410D + XZCPV1141L5		
XS1N12PA340	XS512B1PAL2	XS2N12PA340	XS112B3PAL2		
XS1N12PA340D	XS512B1PAM12	XS2N12PA340D	XS112B3PAM12		
XS1N12PA340L1	XS512B1PAL5	XS2N12PA340L1	XS112B3PAL5		
XS1N12PA340L2	XS512B1PAL10	XS2N12PA340L2	XS112B3PAL10		
XS1N12PA340LD	XS512B1PAM12 (1)	XS2N12PC410	XS112B3PCL2		

(1) For the new sensor an integral M12 connector replaces the remote M12 connector on a 0.80 m flying lead.

(2) For the new sensor an M12 connector replaces the M8 connector.

(3) For the new sensor, the metal case replaces the plastic case.

Substitution table

Sensors with the closest functionalities

Inductive proximity sensors

Old sensor	New XS sensor	Old sensor	New XS sensor	Old sensor	New XS sensor
Cylindrical type, DC (continued)		XS1		XS2	
Diameter 18 mm		XS2		XS3	
XS1		XS2		XS4	
XS1M18DA210	XS518B1DAL2	XS2N18NA340	XS118B3NAL2	XS4P18NA370B	XS4P18NA370L01B (4)
XS1M18DA210B	XS518B1DAL01B (4)	XS2N18NA340D	XS118B3NAM12	XS4P18NB370B	XS4P18NB370L01B (4)
XS1M18DA210C	XS518B1DAL01C (4)	XS2N18NA340L1	XS118B3NAL5	XS4P18PA370B	XS4P18PA370L01B (4)
XS1M18DA210D	XS518B1DAM12	XS2N18NA340L2	XS118B3NAL10	XS4P18PB370B	XS4P18PB370L01B (4)
XS1M18DA210G	XS518B1DAL01G (4)	XS2N18NA340L2	XS118B3NAL5	XS4P18PC410L1	XS4P18PC410D + XZCPV1141L5
XS1M18DA210L1	XS518B1DAL5	XS2N18NB340	XS118B3NBL2		
XS1M18DA210L2	XS518B1DAL10	XS2N18NB340D	XS118B3NBL10		
XS1M18DA210LD	XS518B1DAL08M12	XS2N18NB340L2	XS118B3NBL2		
XS1M18DB210	XS518B1DBL2	XS2N18NC410L2	XS2N18NC410D + XZCPV1141L10		
XS1M18DB210B	XS518B1DBL01B (4)	XS2N18PC410	XS118B3PCL2		
XS1M18DB210D	XS518B1DBM12	XS2N18PC410D	XS118B3PCM12		
XS1M18DB210LD	XS518B1DBL08M12	XS2N18PC410L1	XS118B3PCM12 + XZCPV1141L5		
		XS2N18NB340D	XS118B3NBM12		
XS1M18DA214D	XS518B1CAM12	XS2N18PA340	XS118B3PAL2		
XS1M18DA214LD	XS518B1CAL08M12	XS2N18PA340D	XS118B3PAM12		
		XS2N18PA340L1	XS118B3PAL5		
XS1M18NA370	XS518BLNAL2	XS2N18PA340L2	XS118B3PAL10		
XS1M18NA370A	XS618B1NAL01U78 (4)	XS2N18PB340	XS118B3PBL2		
XS1M18NA370B	XS618B1NAL01B (4)	XS2N18PB340D	XS118B3PBM12		
XS1M18NA370C	XS618B1NAL01C (4)	XS2M18NA370	XS618B1NAL2		
XS1M18NA370D	XS518BLNAM12	XS2M18NA370A	XS618B1NAL01U78 (4)		
XS1M18NA370L1	XS518BLNAL5	XS2M18NA370B	XS618B1NAL01B (4)		
XS1M18NA370L2	XS518BLNAL10	XS2M18NA370C	XS618B1NAL01C (4)		
XS1M18NB370	XS518BLNBL2	XS2M18NA370D	XS618B1NAM12		
XS1M18NB370B	XS618B1NBL01B (4)	XS2M18NA370G	XS618B1NAL5		
XS1M18NB370C	XS618B1NBL01C (4)	XS2M18NA370L1	XS618B1NAL10		
XS1M18NB370D	XS518BLNBLM12	XS2M18NA370L2	XS618B1NBL2		
XS1M18NB370L1	XS518BLNBL5	XS2M18PB370			
XS1M18NB370L2	XS518BLNBL10	XS2M18PB370A			
XS1M18PA370	XS518BLPAL2	XS2M18PB370B			
XS1M18PA370A	XS618B1PAL01U78 (4)	XS2M18PB370C			
XS1M18PA370B	XS618B1PAL01B (4)	XS2M18PB370D			
XS1M18PA370C	XS618B1PAL01C (4)	XS2M18PB370G			
XS1M18PA370D	XS518BLPAM12	XS2M18PB370LA			
XS1M18PA370G	XS618B1PAL01G (4)	XS2M18PB370L1			
XS1M18PA370DTQ	XS518BLPAM12TQ	XS2M18PB370L2			
XS1M18PA370G	XS618B1PAL01G (4)				
XS1M18PA370L1	XS518BLPAL5				
XS1M18PA370L2	XS518BLPAL10				
XS1M18PA370LA	XS618B1PAL08U78				
XS1M18PA370LD	XS518BLPAM12 (1)				
XS1M18PA370DTQ	XS518BLPAM12TQ				
XS1M18PA370TF	XS518BLPAL2TF				
XS1M18PB370	XS518BLPBL2				
XS1M18PB370A	XS618B1PBL01U78 (4)				
XS1M18PB370B	XS618B1PBL01B (4)				

(1) For the new sensor an integral M12 connector replaces the remote M12 connector on a 0.80 m flying lead.

(3) For the new sensor, the metal case replaces the plastic case.

(4) For the new sensor, connectors A, B, C and G on 0.1 m flying lead replace integral connectors A, B, C and G.

Substitution table

Sensors with the closest functionalities

Inductive proximity sensors

Old sensor	New XS sensor	Old sensor	New XS sensor	Old sensor	New XS sensor
Cylindrical type, DC (continued)					
Diameter 30 mm					
XS1					
XS1M30DA210	XS530B1DAL2	XS1N30NA340	XS530B1NAL2	XS2M30PA370G	XS630B1PAL01G (4)
XS1M30DA210B	XS530B1DAL01B (4)	XS1N30NA340D	XS530B1NAM12	XS2M30PA370L1	XS630B1PAL5
XS1M30DA210C	XS530B1DAL01C (4)	XS1N30NA340L1	XS530B1NAL5	XS2M30PA370L2	XS630B1PAL10
XS1M30DA210D	XS530B1DAM12	XS1N30NA340L2	XS530B1NAL10	XS2M30PB370	XS630B1PBL2
XS1M30DA210G	XS530B1DAL01G (4)	XS1N30NB340	XS530B1NBL2	XS2M30PB370B	XS630B1PBL01B (4)
XS1M30DA210L1	XS530B1DAL5	XS1N30NB340D	XS530B1NBM12	XS2M30PB370C	XS630B1PBL01C (4)
XS1M30DA210L2	XS530B1DAL10	XS1N30PA340	XS530B1PAL2	XS2M30PB370D	XS630B1PBM12
XS1M30DA210LD	XS530B1DAL08M12	XS1N30PA340D	XS530B1PAM12	XS2M30PB370G	XS630B1PBL01G (4)
XS1M30DB210	XS530B1DBL2	XS1N30PA340L1	XS530B1PAL5	XS2M30PB370L1	XS630B1PBL5
XS1M30DB210B	XS530B1DBL01B (4)	XS1N30PA340L2	XS530B1PAL10	XS2M30PB370L2	XS630B1PBL10
XS1M30DB210D	XS530B1DBM12	XS1N30PB340	XS530B1PBL2		
XS1M30DB210LD	XS530B1DBM12 (1)	XS1N30PB340D	XS530B1PBM12		
				XS3	
		XS2		XS3P30NA340	XS530B1NAL2 (3)
		XS2N30NA340	XS130B3NAL2	XS3P30NA340D	XS530B1NAM12 (3)
		XS2N30NA340D	XS130B3NAM12	XS3P30NA340L1	XS530B1NAL5 (3)
		XS2N30NA340L1	XS130B3NAL5	XS3P30PA340	XS530B1PAL2 (3)
		XS2N30NA340L2	XS130B3NAL10	XS3P30PA340D	XS530B1PAM12 (3)
		XS2N30NB340	XS130B3NBL2	XS3P30PA340L1	XS530B1PAL5 (3)
		XS2N30NC410L1	XS2N30NC410D + XZCPV1141L5	XS3P30PA340L2	XS530B1PAL10 (3)
		XS2N30PC410	XS130B3PCL2	XS3P30PA370	XS530BLPAL2 (3)
		XS2N30PC410D	XS130B3PCM12	XS3P30PA370L1	XS530BLPAL5 (3)
		XS2N30PC410L1	XS130B3PCM12 + XZCPV1141L5	XS3P30PA370L2	XS530BLPAL10 (3)
		XS2N30NB340D	XS130B3NBM12	XS3P30NA370	XS530BLNAL2 (3)
		XS2N30PA340	XS130B3PAL2	XS3P30NA370L1	XS530BLNAL5 (3)
		XS2N30PA340D	XS130B3PAM12		
		XS2N30PA340L1	XS130B3PAL5	XS4	
		XS2N30PA340L2	XS130B3PAL10	XS4P30NA370B	XS4P30NA370L01B (4)
		XS2N30PB340	XS130B3PBL2	XS4P30NB370B	XS4P30NB370L01B (4)
		XS2N30PB340D	XS130B3PBM12	XS4P30NC410L2	XS4P30NC410D + XZCPV1141L10
				XS4P30PA370B	XS4P30PA370L01B (4)
				XS4P30PB370B	XS4P30PB370L01B (4)
				XS4P30PC410L1	XS4P30PC410D + XZCPV1141L5
				XS4P30PC410L2	XS4P30PC410D + XZCPV1141L10
		XS2M30NA370	XS630B1NAL2		
		XS2M30NA370B	XS630B1NAL01B (4)		
		XS2M30NA370C	XS630B1NAL01C (4)		
		XS2M30NA370D	XS630B1NAM12		
		XS2M30NA370L1	XS630B1NAL5		
		XS2M30NA370L2	XS630B1NAL10		
		XS2M30NB370	XS630B1NBL2		
		XS2M30NB370B	XS630B1NBL01B (4)		
		XS2M30NB370C	XS630B1NBL01C (4)		
		XS2M30NB370D	XS630B1NBM12		
		XS2M30NB370L1	XS630B1NBL5		
		XS2M30NB370L2	XS630B1NBL10		
		XS2M30PA370	XS630B1PAL2		
		XS2M30PA370A	XS630B1PAL01U78 (4)		
		XS2M30PA370B	XS630B1PAL01B (4)		
		XS2M30PA370C	XS630B1PAL01C (4)		
		XS2M30PA370D	XS630B1PAL5		
		XS2M30PB370	XS630B1PBL2		
		XS2M30PB370B	XS630B1PBL01B (4)		
		XS2M30PB370C	XS630B1PBL01C (4)		
		XS2M30PB370D	XS630B1PBM12		
		XS2M30PB370G	XS630B1PBL01G (4)		
		XS2M30PB370L1	XS630B1PBL5		
		XS2M30PB370L2	XS630B1PBL10		

(1) For the new sensor an integral M12 connector replaces the remote M12 connector on a 0.80 m flying lead.

(3) For the new sensor, the metal case replaces the plastic case.

(4) For the new sensor, connectors A, B, C and G on 0.1 m flying lead replace integral connectors A, B, C and G.

(5) For the new sensor, Sn = 15 mm instead of 20 mm.

Substitution table

Sensors with the closest functionalities

Inductive proximity sensors

Old sensor	New XS sensor	Old sensor	New XS sensor	Old sensor	New XS sensor
Cylindrical type, AC or DC		Diameter 18 mm (continued)		Diameter 30 mm (continued)	
Diameter 12 mm		XS1		XS1M30MB230C	
XS1		XS1M18MA239A	XS1M18MA239L01A (4)	XS1M30MB230G	XS630B1MBL01G (4)
<i>XS1M12MA230</i>	XS512B1MAL2	<i>XS1M18MA239K</i>	XS618B1MAU20 (5)	<i>XS1M30MB230K</i>	XS530B1MBU20
<i>XS1M12MA230K</i>	XS512B1MAU20	XS2		<i>XS1M30MB230L1</i>	XS530B1MBL5
<i>XS1M12MA230L1</i>	XS512B1MAL5	<i>XS2M18MA230</i>	XS618B1MAL2	<i>XS1M30MB230L2</i>	XS530B1MBL10
<i>XS1M12MA230L2</i>	XS512B1MAL10	<i>XS2M18MA230A</i>	XS618B1MAL01U78 (4)	<i>XS1M30MA239</i>	XS630B1MAL2 (5)
<i>XS1M12MB230</i>	XS512B1MBL2	<i>XS2M18MA230B</i>	XS618B1MAL01B (4)	<i>XS1M30MA239A</i>	XS1M30MA239L01A (4)
<i>XS1M12MB230K</i>	XS512B1MBU20	<i>XS2M18MA230C</i>	XS618B1MAL01C (4)	XS2	
<i>XS1M12MB230L1</i>	XS512B1MBL5	<i>XS2M18MA230G</i>	XS618B1MAL01G (4)	<i>XS2M30MA230</i>	XS630B1MAL2
<i>XS1M12MB230L2</i>	XS512B1MBL10	<i>XS2M18MA230K</i>	XS618B1MAU20	<i>XS2M30MA230A</i>	XS630B1MAL01U78 (4)
<i>XS1M12MA239</i>	XS612B1MAL2	<i>XS2M18MA230L1</i>	XS618B1MAL5	<i>XS2M30MA230B</i>	XS630B1MAL01B (4)
<i>XS1M12MA239K</i>	XS612B1MAU20	<i>XS2M18MA230L2</i>	XS618B1MAL10	<i>XS2M30MA230C</i>	XS630B1MAL01C (4)
XS2		<i>XS2M18MB230</i>	XS618B1MBL2	<i>XS2M30MA230G</i>	XS630B1MAL01G (4)
<i>XS2M12MA230</i>	XS612B1MAL2	<i>XS2M18MB230A</i>	XS618B1MBL01U78 (4)	<i>XS2M30MA230K</i>	XS630B1MAU20
<i>XS2M12MA230K</i>	XS612B1MAU20	<i>XS2M18MB230B</i>	XS618B1MBL01B (4)	<i>XS2M30MA230C</i>	XS630B1MAL5
<i>XS2M12MA230L1</i>	XS612B1MAL5	<i>XS2M18MB230C</i>	XS618B1MBL01C (4)	<i>XS2M30MA230G</i>	XS630B1MAL10
<i>XS2M12MA230L2</i>	XS612B1MAL10	<i>XS2M18MB230G</i>	XS618B1MBL01G (4)	<i>XS2M30MA230L1</i>	XS630B1MAL5
<i>XS2M12MB230</i>	XS612B1MBL2	<i>XS2M18MB230K</i>	XS618B1MBU20	<i>XS2M30MA230L2</i>	XS630B1MAL10
<i>XS2M12MB230K</i>	XS612B1MBU20	<i>XS2M18MB230L1</i>	XS618B1MBL5	<i>XS2M30MB230</i>	XS630B1MBL2
<i>XS2M12MB230L1</i>	XS612B1MBL5	<i>XS2M18MB230L2</i>	XS618B1MBL10	<i>XS2M30MB230A</i>	XS630B1MBL01U78 (4)
<i>XS2M12MB230L2</i>	XS612B1MBL10	XS3		<i>XS2M30MB230B</i>	XS630B1MBL01B (4)
XS3		<i>XS3P18MA230</i>	XS618B1MAL2 (3)	<i>XS2M30MB230C</i>	XS630B1MBL01C (4)
<i>XS3P12MA230</i>	XS612B1MAL2 (3)	<i>XS3P18MA230K</i>	XS618B1MAU20 (3)	<i>XS2M30MB230G</i>	XS630B1MBL01G (4)
<i>XS3P12MA230K</i>	XS612B1MAU20 (3)	<i>XS3P18MA230L1</i>	XS618B1MAL5 (3)	<i>XS2M30MB230K</i>	XS630B1MBU20
<i>XS3P12MA230L1</i>	XS612B1MAL5 (3)	<i>XS3P18MA230L2</i>	XS618B1MAL10 (3)	<i>XS2M30MB230L1</i>	XS630B1MBL5
<i>XS3P12MA230L2</i>	XS612B1MAL10 (3)	<i>XS3P18MB230</i>	XS618B1MBL2 (3)	<i>XS2M30MB230L2</i>	XS630B1MBL10
<i>XS3P12MB230</i>	XS612B1MBL2 (3)	<i>XS3P18MB230A</i>	XS618B1MBU20 (3)	XS3	
<i>XS3P12MB230K</i>	XS612B1MBU20 (3)	<i>XS3P18MB230K</i>	XS618B1MBU20 (3)	<i>XS3P30MA230</i>	XS630B1MAL2 (3)
<i>XS3P12MB230L1</i>	XS612B1MBL5 (3)	<i>XS3P18MB230L1</i>	XS618B1MBL5 (3)	<i>XS3P30MA230K</i>	XS630B1MAU20 (3)
<i>XS3P12MB230L2</i>	XS612B1MBL10 (3)	XS4		<i>XS3P30MA230L1</i>	XS630B1MAL5 (3)
Diameter 18 mm		<i>XS4P18MA230B</i>	XS4P18MA230L01B (4)	<i>XS3P30MA230L2</i>	XS630B1MAL10 (3)
XS1		<i>XS4P18MA230C</i>	XS4P18MA230L01C (4)	<i>XS3P30MB230</i>	XS630B1MBL2 (3)
<i>XS1M18MA230</i>	XS518B1MAL2	<i>XS4P18MA230G</i>	XS4P18MA230L01G (4)	<i>XS3P30MB230K</i>	XS630B1MBU20 (3)
<i>XS1M18MA230A</i>	XS618B1MAL01U78 (4)	<i>XS4P18MB230B</i>	XS4P18MB230L01B (4)	<i>XS3P30MB230L1</i>	XS630B1MBL5 (3)
<i>XS1M18MA230B</i>	XS618B1MAL01B (4)	<i>XS4P18MB230C</i>	XS4P18MB230L01C (4)	XS4	
<i>XS1M18MA230C</i>	XS618B1MAL01C (4)	Diameter 30 mm		<i>XS4P30MA230B</i>	XS4P30MA230L01B (4)
<i>XS1M18MA230G</i>	XS618B1MAL01G (4)	XS1		<i>XS4P30MA230C</i>	XS4P30MA230L01C (4)
<i>XS1M18MA230K</i>	XS518B1MAU20	<i>XS1M30MA230</i>	XS530B1MAL2	<i>XS4P30MA230G</i>	XS4P30MA230L01G (4)
<i>XS1M18MA230L1</i>	XS518B1MAL5	<i>XS1M30MA230A</i>	XS630B1MAL01U78 (4)	<i>XS4P30MB230B</i>	XS4P30MB230L01B (4)
<i>XS1M18MA230L2</i>	XS518B1MAL10	<i>XS1M30MA230B</i>	XS630B1MAL01B (4)	<i>XS4P30MB230C</i>	XS4P30MB230L01C (4)
<i>XS1M18MB230</i>	XS518B1MBL2	<i>XS1M30MA230C</i>	XS630B1MAL01C (4)	XS2	
<i>XS1M18MB230A</i>	XS618B1MBL01U78 (4)	<i>XS1M30MA230G</i>	XS630B1MAL01G (4)	<i>XS2M30MA230</i>	XS630B1MAL2
<i>XS1M18MB230B</i>	XS618B1MBL01B (4)	<i>XS1M30MA230K</i>	XS530B1MAU20	<i>XS2M30MA230A</i>	XS630B1MAL01U78 (4)
<i>XS1M18MB230C</i>	XS618B1MBL01C (4)	<i>XS1M30MA230C</i>	XS530B1MAL5	<i>XS2M30MA230B</i>	XS630B1MBL01B (4)
<i>XS1M18MB230G</i>	XS618B1MBL01G (4)	<i>XS1M30MA230G</i>	XS530B1MAL10	<i>XS2M30MA230C</i>	XS630B1MBL01C (4)
<i>XS1M18MB230K</i>	XS518B1MBU20	<i>XS1M30MA230K</i>	XS530B1MBL2	<i>XS2M30MA230G</i>	XS630B1MBL5
<i>XS1M18MB230L1</i>	XS518B1MBL5	<i>XS1M30MA230L1</i>	XS530B1MAL5	<i>XS2M30MA230K</i>	XS630B1MAU20
<i>XS1M18MB230L2</i>	XS518B1MBL10	<i>XS1M30MA230L2</i>	XS530B1MAL10	<i>XS2M30MA230L1</i>	XS630B1MBL5
<i>XS1M18MA239</i>	XS618B1MAL2 (5)	<i>XS1M30MB230</i>	XS530B1MBL2	<i>XS2M30MA230L2</i>	XS630B1MBL10
		<i>XS1M30MB230A</i>	XS630B1MBL01U78 (4)	XS3	
		<i>XS1M30MB230B</i>	XS630B1MBL01B (4)	<i>XS3P30MA230</i>	XS630B1MAL2 (3)

(3) For the new sensor, the metal case replaces the plastic case.

(4) For the new sensor, connectors A, B, C and G on 0.1 m flying lead replace integral connectors A, B, C and G.

(5) For the new sensor, Sn = 8 mm instead of 10 mm.

Substitution table

Sensors with the closest functionalities

Inductive proximity sensors

Old sensor	New XS sensor	Old sensor	New XS sensor
Block type		40 x 40 x 70 mm and 40 x 40 x 117 mm (continued)	
40 x 40 x 70 mm and 40 x 40 x 117 mm		XS8	
XS7		XS8C40DA210	XS8C4A1DPG13
XS7C40DA210	XS7C4A1DPG13	XS8C40DA210H29	XS8C4A1DPP20
XS7C40DA210A	XS7C4A1DPU78	XS8C40DA214D	XS8C4A1DPM12
XS7C40DA210D	XS7C4A1DPM12	XS8C40DP210	XS8C4A1DPG13
XS7C40DA210H29	XS7C4A1DPP20	XS8C40DP210H29	XS8C4A1DPP20
XS7C40DA210H7	XS7C4A1DPN12	XS8C40DP210H7	XS8C4A1DPN12
XS7C40DA214D	XS7C4A1DPM12	XS8C40FP260	XS8C4A1MPG13
XS7C40DP210	XS7C4A1DPG13	XS8C40FP260H29	XS8C4A1MPP20
XS7C40DP210H29	XS7C4A1DPP20	XS8C40FP260H7	XS8C4A1MPN12
XS7C40DP210H7	XS7C4A1DPN12	XS8C40MP230	XS8C4A1MPG13
XS7C40FP260	XS7C4A1MPG13	XS8C40MP230H29	XS8C4A1MPP20
XS7C40FP260A	XS7C4A1MPU78	XS8C40MP230H7	XS8C4A1MPN12
XS7C40FP260H29	XS7C4A1MPP20	XS8C40NC440	XS8C4A1NCG13
XS7C40FP260H7	XS7C4A1MPN12	XS8C40NC440H29	XS8C4A1NCP20
XS7C40KPM40	XS9C4A1PCG13	XS8C40NC449	XS8C4A4NCG13
XS7C40KPM40H29	XS9C4A1PCP20	XS8C40NC449H29	XS8C4A4NCP20
XS7C40KPM40H7	XS9C4A1PCN12	XS8C40NC449H7	XS8C4A4NCN12
XS7C40MP230	XS7C4A1MPG13	XS8C40PC440	XS8C4A1PCG13
XS7C40MP230A	XS7C4A1MPU78	XS8C40PC440D	XS8C4A1PCM12
XS7C40MP230H29	XS7C4A1MPP20	XS8C40PC440H29	XS8C4A1PCP20
XS7C40MP230H7	XS7C4A1MPN12	XS8C40PC440H7	XS8C4A1PCN12
XS7C40NC440	XS8C4A1NCG13	XS8C40PC449	XS8C4A4PCG13
XS7C40NC440D	XS8C4A1NCM12	XS8C40PC449D	XS8C4A4PCM12
XS7C40NC440H29	XS8C4A1NCP20	XS8C40PC449H29	XS8C4A4PCP20
XS7C40NC440H7	XS8C4A1NCN12	XS8C40PC449H7	XS8C4A4PCN12
XS7C40NC449	XS8C4A1NCG13	XS8T4NC440	XS8C2A1NCM12 + XZCP1141L2
XS7C40NC449H29	XS8C4A1NCP20	XS8T4NC440LD01	XS8C2A1NCM12
XS7C40NC449H7	XS8C4A1NCN12	XS8T4PC440	XS8C2A1PCM12 + XZCP1141L2
XS7C40PC440	XS8C4A1PCG13	XS8T4PC440L1	XS8C2A1PCM12 + XZCP1141L5
XS7C40PC440D	XS8C4A1PCM12	XS8T4PC440L2	XS8C2A1PCM12 + XZCP1141L10
XS7C40PC440H29	XS8C4A1PCP20	XS8T4PC440LD	XS8C2A1PCM12
XS7C40PC440H7	XS8C4A1PCN12	XS8T4PC440LD01	XS8C2A1PCM12
XS7C40PC449	XS8C4A1PCG13		
XS7C40PC449D	XS8C4A1PCM12		
XS7C40PC449H29	XS8C4A1PCP20		
XS7C40PC449H7	XS8C4A1PCN12		
XS7T4DA210	XS7C2A1DAM12 + XZCP1141L2		
XS7T4DA214LD	XS8C2A1CAM12	XSCH203629	XS9C4A2A2G13
XS7T4DA214LD01	XS8C2A1CAM12	XSCH203629H7	XS9C4A2A2N12
XS7T4DA214LD01W	XS8C2A1CAM12 + XSZPKC2	XSCH207629	XS9C4A2A1G13
XS7T4DA214LDW	XS8C2A1CAM12 + XSZPKC2	XSCH207629H7	XS9C4A2A1N12
XS7T4NC440	XS8C2A1NCM12 + XZCP1141L2		
XS7T4NC440LD	XS8C2A1NCM12		
XS7T4NC440LD01	XS8C2A1NCM12		
XS7T4PC440	XS8C2A1PCM12 + XZCP1141L2		
XS7T4PC440LD	XS8C2A1PCM12		
		40 x 40 x 117 mm	
		XSCH	
		XSCH203629	XS9C4A2A2G13
		XSCH203629H7	XS9C4A2A2N12
		XSCH207629	XS9C4A2A1G13
		XSCH207629H7	XS9C4A2A1N12

A	XS130B3NBL2	33	XS1N05NB310	68	XS212SANAM12	92	XS4P08PA370	64	
AB1FU10135U	118	XS130B3NBM12	33	XS1N05NB311	68	XS212SAPAL2	92	XS4P08PB340	64
X	XS130B3PAL2	33	XS1N05NB311S	68	XS212SAPAM12	92	XS4P08PC410	56	
XS106B3NAL2	32	XS130B3PAL2TQ	33	XS1N05PA310	68	XS218AAMAL2	98	XS4P12AB110	81
XS106B3NAM8	32	XS130B3PAM12	33	XS1N05PA311	68	XS218AAMAU20	98	XS4P12AB120	81
XS106B3NBL2	32	XS130B3PAM12TQ	33	XS1N05PA311S	68	XS218AANAL2	96	XS4P12KP340	62
XS106B3NBM8	32	XS130B3PBL2	33	XS1N05PB310	68	XS218AANAM12	96	XS4P12KP340D	62
XS106B3PAL2	32	XS130B3PBM12	33	XS1N05PB311	68	XS218AAPAL2	96	XS4P12MA230	64
XS106B3PAL2TQ	32	XS130B3PCL2	60	XS1N05PB311S	68	XS218AAPAM12	96	XS4P12MA230K	64
XS106B3PAM12	32	XS130B3PCM12	60	XS1N08PA349	66	XS218B4NAL2	42	XS4P12MB230	64
XS106B3PAM8	32	XS1L04NA310	68	XS1N08PA349D	66	XS218B4NAM12	42	XS4P12MB230K	64
XS106B3PAM8TQ	32	XS1L04NA310S	68	XS1N08PA349S	66	XS218B4PAL2	42	XS4P12NA340	64
XS106B3PBL2	32	XS1L04NA311	68	XS1N08PB349	66	XS218B4PAL5	42	XS4P12NA370	64
XS106B3PBM8	32	XS1L04NA311S	68	XS1N08PB349D	66	XS218B4PAM12	42	XS4P12NB340	64
XS108B3NAL2	32	XS1L04NB310	68	XS1N08PB349S	66	XS218B4PBL2	42	XS4P12NB370	64
XS108B3NAL2TQ	32	XS1L04NB310S	68	XS1N12NA349	66	XS218B4PBM12	42	XS4P12PA340	64
XS108B3NAM12	32	XS1L04NB311	68	XS1N12NA349D	66	XS218SAMAL2	94	XS4P12PA370	64
XS108B3NAM8	32	XS1L04NB311S	68	XS1N12NB349	66	XS218SAMAU20	94	XS4P12PB340	64
XS108B3NAM8TQ	32	XS1L04PA310	68	XS1N12NB349D	66	XS218SANAL2	92	XS4P12PB370	64
XS108B3NBL2	32	XS1L04PA310S	68	XS1N12NC410	56	XS218SANAM12	92	XS4P12PC410	56
XS108B3NBM12	32	XS1L04PA311	68	XS1N12NC410D	56	XS218SAPAL2	92	XS4P12PC410D	56
XS108B3NBM8	32	XS1L04PA311S	68	XS1N12PA349	66	XS218SAPAM12	92	XS4P18AB110	82
XS108B3PAL2	32	XS1L04PB310	68	XS1N12PA349D	66	XS230AAMAL2	98	XS4P18AB120	82
XS108B3PAL2TQ	32	XS1L04PB310S	68	XS1N12PB349	66	XS230AAMAU20	98	XS4P18KP340	62
XS108B3PAM12	32	XS1L04PB311	68	XS1N12PB349D	66	XS230AANAL2	96	XS4P18KP340D	62
XS108B3PAM12TQ	32	XS1L04PB311S	68	XS1N12PC410	56	XS230AANAM12	96	XS4P18MA230	64
XS108B3PAM8	32	XS1L06NC410	56	XS1N12PC410D	56	XS230AAPAL2	96	XS4P18MA230K	64
XS108B3PAM8TQ	32	XS1L06PC410	56	XS1N18NA349	66	XS230AAPAM12	96	XS4P18MB230	64
XS108B3PBL2	32	XS1M08NC410	56	XS1N18NA349D	66	XS230SAMAL2	94	XS4P18MB230K	64
XS108B3PBM12	32	XS1M08NC410D	56	XS1N18NB349	66	XS230SAMAU20	94	XS4P18NA340	64
XS108B3PBM8	32	XS1M08PC410	56	XS1N18NB349D	66	XS230SANAL2	92	XS4P18NA370	64
XS112B3NAL2	32	XS1M08PC410D	56	XS1N18NC410	57	XS230SANAM12	92	XS4P18NB340	64
XS112B3NAL2TQ	32	XS1M12AB120	81	XS1N18NC410D	57	XS230SAPAL2	92	XS4P18NB370	64
XS112B3NAM12	32	XS1M12KP340	62	XS1N18PA349	66	XS230SAPAM12	92	XS4P18PA340	64
XS112B3NAM12TQ	32	XS1M12KP340D	62	XS1N18PA349D	66	XS2L2SANAL2	92	XS4P18PA370	64
XS112B3NBL2	32	XS1M12MA250	54	XS1N18PB349	66	XS2L2SANAM12	92	XS4P18PB340	64
XS112B3NBM12	32	XS1M12MA250K	54	XS1N18PB349D	66	XS2L2SAPAL2	92	XS4P18PB370	64
XS112B3PAL2	32	XS1M12MB250	54	XS1N18PC410	57	XS2L2SAPAM12	92	XS4P18PC410	57
XS112B3PAL2TQ	32	XS1M12MB250K	54	XS1N18PC410D	57	XS2M08NC410	56	XS4P18PC410D	57
XS112B3PAM12	32	XS1M18AB120	82	XS1N30NA349	66	XS2M08NC410D	56	XS4P30AB110	83
XS112B3PAM12TQ	32	XS1M18KP340	62	XS1N30NA349D	66	XS2M12KP340	62	XS4P30AB120	83
XS112B3PBL2	32	XS1M18KP340D	62	XS1N30NB349	66	XS2M12KP340D	62	XS4P30KP340	62
XS112B3PBM12	32	XS1M18KPM40	112	XS1N30NB349D	66	XS2M12MA250	54	XS4P30KP340D	62
XS112B3PBM12TQ	32	XS1M18KPM40D	112	XS1N30NC410	57	XS2M12MA250K	54	XS4P30MA230	64
XS112B3PBM12TQ	32	XS1M18MA250	54	XS1N30NC410D	57	XS2M12MB250	54	XS4P30MA230K	64
XS112B3PCL2	60	XS1M18MA250K	54	XS1N30PA349	66	XS2M18KP340	62	XS4P30MB230	64
XS112B3PCM12	60	XS1M18MB250	54	XS1N30PA349D	66	XS2M18KP340D	62	XS4P30MB230K	64
XS118B3NAL2	33	XS1M18MB250K	54	XS1N30PB349	66	XS2M18MA250	54	XS4P30NA340	64
XS118B3NAL2TQ	33	XS1M18PAS20	116	XS1N30PB349D	66	XS2M18MA250K	54	XS4P30NA370	64
XS118B3NAM12	33	XS1M18PAS20D	117	XS1N30PC410	57	XS2M18MB250	54	XS4P30NB340	64
XS118B3NAM12TQ	33	XS1M18PAS40	116	XS1N30PC410D	57	XS2M18MB250K	54	XS4P30NB370	64
XS118B3NBL2	33	XS1M18PAS40D	117	XS212AANAL2	96	XS2M30KP340	62	XS4P30PA340	64
XS118B3NBM12	33	XS1M30AB120	83	XS212AANAM12	96	XS2M30KP340D	62	XS4P30PA370	64
XS118B3PAL2	33	XS1M30KP340	62	XS212AAPAL2	96	XS2M30MA250	54	XS4P30PB340	64
XS118B3PAL2TQ	33	XS1M30KP340D	62	XS212AAPAM12	96	XS2M30MA250K	54	XS4P30PB370	64
XS118B3PAM12	33	XS1M30KPM40	113	XS212B4NAL2	42	XS2M30MB250	54	XS4P30PC410	57
XS118B3PAM12TQ	33	XS1M30KPM40LD	113	XS212B4NAM12	42	XS2M30MB250K	54	XS4P30PC410D	57
XS118B3PBL2	33	XS1M30MA250	54	XS212B4NBL2	42	XS4P08MA230	64	XS506B1NAL2	22
XS118B3PBM12	33	XS1M30MA250K	54	XS212B4PAL2	42	XS4P08MA230K	64	XS506B1NAM8	22
XS118B3PCL2	60	XS1M30MB250	54	XS212B4PAL5	42	XS4P08MB230	64	XS506B1NBL2	22
XS118B3PCM12	60	XS1M30MB250K	54	XS212B4PAM12	42	XS4P08MB230K	64	XS506B1NBM8	22
XS130B3NAL2	33	XS1N05NA310	68	XS212B4PBL2	42	XS4P08NA340	64	XS506B1PAL2	22
XS130B3NAM12	33	XS1N05NA311	68	XS212B4PBM12	42	XS4P08NB340	64	XS506B1PAM12	22
XS130B3NAM12TQ	33	XS1N05NA311S	68	XS212SANAL2	92	XS4P08PA340	64	XS506B1PAM8	22

XS506B1PBL2	22	XS512BLPBM12	23	XS530B1PAL2	22	XS612B1MBU20	38	XS618B4NAL2	40
XS506B1PBM8	22	XS512BSCAL08M12	26	XS530B1PAM12	22	XS612B1NAL2	34	XS618B4NAM12	40
XS506BSCAL01M12	26	XS512BSCAM12	26	XS530B1PBL2	22	XS612B1NAM12	34	XS618B4NBL2	40
XS506BSCAL2	26	XS512BSDAL2	26	XS530B1PBM12	22	XS612B1NBL2	34	XS618B4NBM12	40
XS506BSCBL2	26	XS512BSDAM12	26	XS530BLNAL2	23	XS612B1NBM12	34	XS618B4PAL2	40
XS508B1CAL08M12	27	XS512BSDBL2	26	XS530BLNAM12	23	XS612B1PAL2	34	XS618B4PAM12	40
XS508B1CAM12	27	XS512BSDBM12	26	XS530BLNBL2	23	XS612B1PAM12	34	XS618B4PBL2	40
XS508B1DAL08M12	27	XS518B1CAL08M12	27	XS530BLNBM12	23	XS612B1PBL2	34	XS618B4PBM12	40
XS508B1DAL2	27	XS518B1CAM12	27	XS530BLPAL2	23	XS612B1PBM12	34	XS630B1DAL2	36
XS508B1DAM12	27	XS518B1DAL01B	27	XS530BLPAM12	23	XS612B2NAL01M12	72	XS630B1DAM12	36
XS508B1DBL2	27	XS518B1DAL01C	27	XS530BLPBL2	23	XS612B2NBL01M12	72	XS630B1DBL2	36
XS508B1DBM12	27	XS518B1DAL01G	27	XS530BLPBM12	23	XS612B2PAL01M12	72	XS630B1DBM12	36
XS508B1NAL2	22	XS518B1DAL2	27	XS530BSCAL08M12	26	XS612B2PBL01M12	72	XS630B1MAL01B	38
XS508B1NAM12	22	XS518B1DAL2TF	27	XS530BSCAM12	26	XS612B3DAL2	36	XS630B1MAL01C	38
XS508B1NAM8	22	XS518B1DAM12	27	XS530BSDAL2	26	XS612B3DAM12	36	XS630B1MAL01G	38
XS508B1NBL2	22	XS518B1DBL01B	27	XS530BSDAM12	26	XS612B3DBL2	36	XS630B1MAL2	38
XS508B1NBM12	22	XS518B1DBL08M12	27	XS530BSDBL2	26	XS612B3DBM12	36	XS630B1MAU20	38
XS508B1NBM8	22	XS518B1DBL2	27	XS530BSDBM12	26	XS612B4NAL2	40	XS630B1MBL01B	38
XS508B1PAL2	22	XS518B1DBM12	27	XS606B1DAL2	36	XS612B4NAM12	40	XS630B1MBL01C	38
XS508B1PAM12	22	XS518B1MAL2	30	XS606B1DBL2	36	XS612B4NBL2	40	XS630B1MBL2	38
XS508B1PAM8	22	XS518B1MAU20	30	XS606B3CAL01M12	36	XS612B4NBM12	40	XS630B1MBU20	38
XS508B1PBL2	22	XS518B1MBL2	30	XS606B3CAL2	36	XS612B4PAL2	40	XS630B1NAL01B	34
XS508B1PBM12	22	XS518B1MBU20	30	XS606B3CBL2	36	XS612B4PAM12	40	XS630B1NAL2	34
XS508B1PBM8	22	XS518B1NAL2	22	XS608B1DAL2	36	XS612B4PBL2	40	XS630B1NAM12	34
XS508BLNAL2	23	XS518B1NAM12	22	XS608B1DAM12	36	XS612B4PBM12	40	XS630B1NBL2	34
XS508BLNAM12	23	XS518B1NBL2	22	XS608B1DBL2	36	XS618B1DAL2	36	XS630B1NBM12	34
XS508BLNBL2	23	XS518B1NBM12	22	XS608B1DBM12	36	XS618B1DAM12	36	XS630B1PAL01B	34
XS508BLNBM12	23	XS518B1PAL2	22	XS608B1DAL2	34	XS618B1DBL2	36	XS630B1PAL01C	34
XS508BLPAL2	23	XS518B1PAM12	22	XS608B1NAM12	34	XS618B1DBM12	36	XS630B1PAL01G	34
XS508BLPAM12	23	XS518B1PBL2	22	XS608B1NAM8	34	XS618B1MAL01B	38	XS630B1PAL2	34
XS508BLPBL2	23	XS518B1PBM12	22	XS608B1NBL2	34	XS618B1MAL01C	38	XS630B1PAM12	34
XS508BLPBM12	23	XS518BLNAL2	23	XS608B1NBM12	34	XS618B1MAL01G	38	XS630B1PBL01C	34
XS508BSCAL01M12	26	XS518BLNAM12	23	XS608B1NBM8	34	XS618B1MAL2	38	XS630B1PBL2	34
XS508BSCAL08M12	26	XS518BLNBL2	23	XS608B1PAL2	34	XS618B1MAU20	38	XS630B1PBM12	34
XS508BSCAL2	26	XS518BLNBM12	23	XS608B1PAM12	34	XS618B1MBL01B	38	XS630B2NAL01M12	72
XS508BSCBL01M12	26	XS518BLPAL2	23	XS608B1PAM8	34	XS618B1MBL01C	38	XS630B2NBL01M12	72
XS508BSCBL2	26	XS518BLPAM12	23	XS608B1PBL2	34	XS618B1MBL01G	38	XS630B2PAL01M12	72
XS512B1CAL08M12	27	XS518BLPBL2	23	XS608B1PBM12	34	XS618B1MBL2	38	XS630B2PBL01M12	72
XS512B1CAM12	27	XS518BLPBM12	23	XS608B1PBM8	34	XS618B1MBU20	38	XS630B3DAL2	36
XS512B1DAL08U78	27	XS518BSCAL08M12	26	XS608B1PCL2	60	XS618B1NAL01B	34	XS630B3DAM12	36
XS512B1DAL2	27	XS518BSCAM12	26	XS608B1PCM12	60	XS618B1NAL2	34	XS630B3DBL2	36
XS512B1DAM12	27	XS518BSDAL2	26	XS608B3CAL01M12	36	XS618B1NAM12	34	XS630B3DBM12	36
XS512B1DBL08M12	27	XS518BSDAM12	26	XS608B3CAL2	36	XS618B1NBL2	34	XS630B4MAL2	44
XS512B1DBL2	27	XS518BSDBL2	26	XS608B3CBL01M12	36	XS618B1NBM12	34	XS630B4MAU20	44
XS512B1DBM12	27	XS518BSDBM12	26	XS608B3CBL2	36	XS618B1PAL01B	34	XS630B4MBL2	44
XS512B1MAL2	30	XS530B1CAL08M12	27	XS608B4NAL2	40	XS618B1PAL01C	34	XS630B4MBU20	44
XS512B1MAU20	30	XS530B1CAM12	27	XS608B4NAM12	40	XS618B1PAL01G	34	XS630B5NAL2	40
XS512B1MBL2	30	XS530B1DAL01B	27	XS608B4NAM8	40	XS618B1PAL2	34	XS630B5NAM12	40
XS512B1MBU20	30	XS530B1DAL01C	27	XS608B4NBL2	40	XS618B1PAM12	34	XS630B5NBL2	40
XS512B1NAL2	22	XS530B1DAL01G	27	XS608B4NBM12	40	XS618B1PBL01B	34	XS630B5PAL2	40
XS512B1NAM12	22	XS530B1DAL2	27	XS608B4NBM8	40	XS618B1PBL2	34	XS630B5PAM12	40
XS512B1NBL2	22	XS530B1DAL2TF	27	XS608B4PAL2	40	XS618B1PBM12	34	XS630B5PBL2	40
XS512B1NBM12	22	XS530B1DAM12	27	XS608B4PAM12	40	XS618B2NAL01M12	72	XS630B5PBM12	40
XS512B1PAL2	22	XS530B1DBL01B	27	XS608B4PAM8	40	XS618B2NBL01M12	72	XS7C1A1CAL01M12	48
XS512B1PAM12	22	XS530B1DBL2	27	XS608B4PBL2	40	XS618B2PAL01M12	72	XS7C1A1CAL08M12	48
XS512B1PBL2	22	XS530B1DBM12	27	XS608B4PBM12	40	XS618B2PBL01M12	72	XS7C1A1DAL01M12	48
XS512B1PBM12	22	XS530B1MAL2	30	XS608B4PBM8	40	XS618B3DAL2	36	XS7C1A1DAL2	48
XS512BLNAL2	23	XS530B1MAU20	30	XS612B1DAL2	36	XS618B3DAM12	36	XS7C1A1DAM8	48
XS512BLNAM12	23	XS530B1MBL2	30	XS612B1DAM12	36	XS618B3DBL2	36	XS7C1A1DBL01M12	48
XS512BLNBL2	23	XS530B1MBU20	30	XS612B1DBL2	36	XS618B3DBM12	36	XS7C1A1DBL2	48
XS512BLNBM12	23	XS530B1NAL2	22	XS612B1DBM12	36	XS618B4MAL2	44	XS7C1A1DBM8	48
XS512BLPAL2	23	XS530B1NAM12	22	XS612B1MAL2	38	XS618B4MAU20	44	XS7C1A1NAL01M12	48
XS512BLPAM12	23	XS530B1NBL2	22	XS612B1MAU20	38	XS618B4MBL2	44	XS7C1A1NAL2	48
XS512BLPBL2	23	XS530B1NBM12	22	XS612B1MBL2	38	XS618B4MBU20	44	XS7C1A1NAM8	48

XS7C1A1NBL01M12	48	XS7G12MA230	104	XS8D1A1PAM12	74	XS9C4A1NCP20	114	XSZB118	96
XS7C1A1NBL2	48	XS7G12MB230	104	XS8D1A1PBL2	74	XS9C4A1PCP20	114		98
XS7C1A1NBM8	48	XS7G12NA140	102	XS8D1A1PBM12	74	XS9C4A2A1P20	88		118
XS7C1A1PAL01M12	48	XS7G12NA140S	102	XS8E1A1MAL01U20	74	XS9C4A2A2P20	88	XSZB130	22
XS7C1A1PAL2	48	XS7G12NC440	102	XS8E1A1MAL2	74	XS9D111A1L2	85		23
XS7C1A1PAM8	48	XS7G12PA140	102	XS8E1A1MBL01U20	74	XS9D111A1M12	85		26
XS7C1A1PBL01M12	48	XS7G12PA140S	102	XS8E1A1MBL2	74	XS9D111A2L2	87		27
XS7C1A1PBL2	48	XS7G12PC440	102	XS8E1A1NAL01M12	74	XS9D111A2M12	87		30
XS7C1A1PBM8	48	XS7J1A1DAL01M8	46	XS8E1A1NAL2	74	XS9E111A1L01M12	85		33
XS7C2A1DAM12	50	XS7J1A1DAL2	46	XS8E1A1NAM8	74	XS9E111A1L2	85		34
XS7C2A1DBM12	50	XS7J1A1DBL01M8	46	XS8E1A1NBL01M12	74	XS9E111A2L01M12	87		36
XS7C2A1MAU20	50	XS7J1A1DBL2	46	XS8E1A1NBL2	74	XS9E111A2L2	87		38
XS7C2A1MBU20	50	XS7J1A1NAL01M8	46	XS8E1A1NBM8	74	XS9E111A2L2	87		40
XS7C2A1NAM12	50	XS7J1A1NAL2	46	XS8E1A1PAL01M12	74	XS9E111A2L01M12	87		44
XS7C2A1NBM12	50	XS7J1A1NBL01M8	46	XS8E1A1PAL2	74	XS9E111A2L2	87		54
XS7C2A1PAM12	50	XS7J1A1NBL2	46	XS8E1A1PAM8	74	XS9E111A2L2	87		57
XS7C2A1PBM12	50	XS7J1A1PAL01M8	46	XS8E1A1PBL01M12	74	XS9E111A2L01M12	87		60
XS7C4A1DPP20	52	XS7J1A1PAL2	46	XS8E1A1PBL2	74	XS9E111A2L2	87		62
XS7C4A1MPP20	52	XS7J1A1PBL01M8	46	XS8E1A1PBM8	74	XS9F111A1L01M8	85		66
XS7D1A1CAM12	48	XS7J1A1PBL2	46	XS8G12MA230	104	XS9F111A1L2	85	XSZB130	96
XS7D1A1DAL2	48	XS8C1A1MAL01U20	74	XS8G12MA230	104	XS9F111A2L01M8	87		98
XS7D1A1DAM12	48	XS8C1A1MAL2	74	XS8G12NA140	102	XS9F111A2L2	87		118
XS7D1A1DBL2	48	XS8C1A1MBL01U20	74	XS8G12NA140S	102	XSAV11373	77	XSZB165	22
XS7D1A1DBM12	48	XS8C1A1MBL2	74	XS8G12NC440	102	XSAV11801	77		23
XS7D1A1NAL2	48	XS8C1A1NAL01M12	74	XS8G12NC440	102	XSAV12373	77		26
XS7D1A1NAM12	48	XS8C1A1NAL2	74	XS8G12PA140	102	XSAV12373	77		33
XS7D1A1NBL2	48	XS8C1A1NAM8	74	XS8G12PA140S	102	XSAV12801	77		36
XS7D1A1NBM12	48	XS8C1A1NBL01M12	74	XS8G12PC440	102	XSCZ01	118	XSZB165	118
XS7D1A1PAL2	48	XS8C1A1NBL2	74	XS908R1PAM12	100	XSZA020	118	XSZBC00	118
XS7D1A1PAM12	48	XS8C1A1NBM8	74	XS908R4PAM12	100	XSZA034	118	XSZBC10	118
XS7D1A1PBL2	48	XS8C1A1PAL01M12	74		101	XSZB104	118	XSZBC90	118
XS7D1A1PBM12	48	XS8C1A1PAL2	74	XS912R1PAM12	100	XSZB105	118	XSZBD10	118
XS7D1A3CAM12DIN	106	XS8C1A1PAM8	74		101	XSZB108	118	XSZBE00	118
XS7E1A1CAL01M12	48	XS8C1A1PBL01M12	74	XS912R4PAM12	100		22	XSZBE10	118
XS7E1A1CAL08M12	48	XS8C1A1PBL2	74		101	XSZB108	118	XSZBE90	118
XS7E1A1DAL01M12	48	XS8C1A1PBM8	74	XS912S1PAM12	90	XSZB112	118	XSZBF00	118
XS7E1A1DAL2	48	XS8C2A1DAM12	50		91		22	XSZBF90	118
XS7E1A1DAM8	48	XS8C2A1DBM12	50	XS912S4PAM12	90		23	XSZBJ00	118
XS7E1A1DBL01M12	48	XS8C2A1MAU20	50		91		26	XSZBJ90	118
XS7E1A1DBL2	48	XS8C2A1MBU20	50	XS918R1PAM12	100		27	XSZBPM12	72
XS7E1A1DBM8	48	XS8C2A1NCM12	50		101		33		79
XS7E1A1NAL01M12	48	XS8C2A1PCM12	50	XS918R4PAM12	100		34	XSZBPM12	118
XS7E1A1NAL2	48	XS8C2A4DAM12	50		101		36	XSZBS12	90
XS7E1A1NAM8	48	XS8C2A4DBM12	50	XS918RWPAM12	108		38		92
XS7E1A1NBL01M12	48	XS8C2A4MAU20	50		109		40	XSZBS30	90
XS7E1A1NBL2	48	XS8C2A4MBU20	50	XS918S1PAM12	90		42		92
XS7E1A1NBM8	48	XS8C2A4NCM12	50		91		54		94
XS7E1A1PAL01M12	48	XS8C2A4PCM12	50	XS918S4PAM12	90		57	XSZE105	118
XS7E1A1PAL2	48	XS8C4A1DPP20	52		91		60	XSZE108	118
XS7E1A1PAM8	48	XS8C4A1MPP20	52	XS930R1PAM12	100		62	XSZE112	118
XS7E1A1PBL01M12	48	XS8C4A1NCP20	52		101		66	XSZE118	118
XS7E1A1PBL2	48	XS8C4A1PCP20	52	XS930R4PAM12	100	XSZB112	96	XSZE130	118
XS7E1A1PBM8	48	XS8C4A4DPP20	52		101		118	XSZE208	118
XS7F1A1DAL01M8	46	XS8C4A4MPP20	52	XS930S1PAM12	90			XSZE212	118
XS7F1A1DAL2	46	XS8C4A4NCP20	52		91			XSZE218	118
XS7F1A1DBL01M8	46	XS8C4A4PCP20	52	XS930S4PAM12	90	XSZB112	96	XSZE230	118
XS7F1A1DBL2	46	XS8D1A1MAL2	74		91			XSZE308	118
XS7F1A1NAL01M8	46	XS8D1A1MAU20	74	XS9C111A1L01M12	85	XSZB118	22	XSZE312	118
XS7F1A1NAL2	46	XS8D1A1MBL2	74	XS9C111A1L2	85		23	XSZE318	118
XS7F1A1NBL01M8	46	XS8D1A1MBU20	74	XS9C111A2L01M12	87		27	XSZF10	118
XS7F1A1NBL2	46	XS8D1A1NAL2	74	XS9C111A2L2	87		30	XSZP112	118
XS7F1A1PAL01M8	46	XS8D1A1NAM12	74	XS9C111A2L2	87		33	XSZP118	118
XS7F1A1PAL2	46	XS8D1A1NBL2	74	XS9C111A2L2	87		34	XSZP130	118
XS7F1A1PBL01M8	46	XS8D1A1NBM12	74	XS9C111A2L2	87		36	XSZPE13	118
XS7F1A1PBL2	46	XS8D1A1PAL2	74	XS9C11RMBL01U20	79		40	XSZPKC2	115
				XS9C11RPBL01M12	79		42	XSZPSC2	115
				XS9C2A1NCM12	114		44	XTAZ30	118
				XS9C2A1PCM12	114		54	XUZA118	90
				XS9C2A2A1M12	88		57		92
				XS9C2A2A2M12	88		60		94
							62		
							66		
							72		

XUZB2005	92
XUZB32	118
XUZE04	118
XUZE06	118
XUZE08	118
XZCP1141L10	51 100 108
XZCP1141L2	51 100 108
XZCP1141L5	51 100 108
XZCP1241L10	100 108
XZCP1241L2	100 108
XZCP1241L5	100 108
XZCP1865L10	51
XZCP1865L5	51
XZCP1965L10	51
XZCP1965L5	51
XZCPA1141L10	90 92 96
XZCPA1141L2	90 92 96
XZCPA1141L5	90 92 96
XZCPA1241L10	92 96
XZCPA1241L2	92 96
XZCPA1241L5	92 96
XZCPA1865L10	94 98
XZCPA1865L5	94 98
XZCPA1965L10	94 98
XZCPA1965L5	94 98
XZCRA151140A2	92 96
XZCRA151140A5	92 96

Schneider Electric Industries SAS

Head Office
35, rue Joseph Monier
F-92500 Rueil-Malmaison
France

www.tesensors.com

The information provided in this documentation contains general descriptions and/or technical characteristics of the performance of the products contained herein. This documentation is not intended as a substitute for and is not to be used for determining suitability or reliability of these products for specific user applications. It is the duty of any such user or integrator to perform the appropriate and complete risk analysis, evaluation and testing of the products with respect to the relevant specific application or use thereof. Neither Schneider Electric nor any of its affiliates or subsidiaries shall be responsible or liable for misuse of the information contained herein.

Design: Schneider Electric
Photos: Schneider Electric