

# Ultrasonic sensors U500 and UR18

Robust. Economical. Flexible parameterization.



# U500 and UR18 – Ultrasonic sensors for every application.

With the new product families U500 and UR18, Baumer sets a benchmark in ultrasonic sensor technology. These sensors are suitable for both distance measurement and object detection when the highest degree of presence sensing is required. The measurement signal is independent of the color, shape and transparency properties of an object.

## Your advantages at a glance

- Highest quality with high economic efficiency
- Robust and resistant sensor, thanks to hermetically sealed sensor element, ensures maximum process reliability and longevity
- Measurement almost to the sensor surface due to the short blind zone of 20 mm with a range of 1000 mm
- Flexible and application-specific parameterization and additional data thanks to IO-Link
- Wide range of mounting options in all designs



## The sensor in detail

The sensor element as an attack surface for chemical and mechanical influences is now uniquely resistant at Baumer. Thanks to a hermetic seal with the extremely robust PEEK foil, the ultrasonic sensor

becomes considerably more resistant overall. They can withstand even the toughest conditions, such as the leak test up to IP 69 or unrealistic tough conditions such as sandblasting.



Extremely robust sensor element with laser-welded PEEK foil

Parameterization via IO-Link or directly on the sensor with *qTeach*®

Process and diagnostic data via IO-Link interface

# Flexible parameterization

## Variable sonic beam

- Targeted adjustment of the sonic beam width
- Narrow sonic beam for even smallest openings
- Large sonic beam, useful for averaging over big surface areas
- Setting via IO-Link

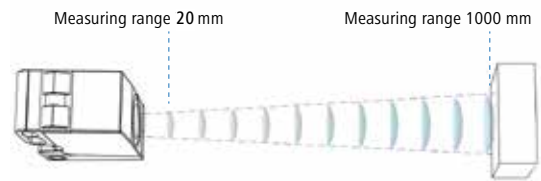

## Switching points

- Free selection of the measured values at which the sensor is to switch
- Definition of a switching window
- Setting via IO-Link and *qTeach*®

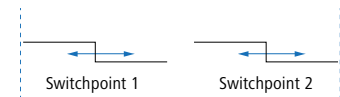

## Adjustable measuring range

- Limit the measuring range to increase the resolution of the analog output
- Setting via IO-Link and *qTeach*®

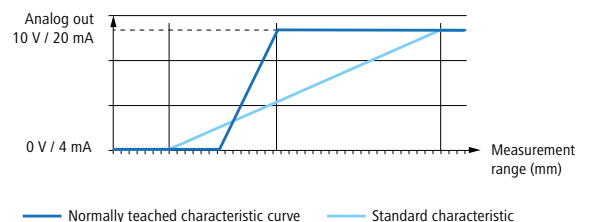

## Adjustable filter function

- Filter function reduces noise for more stable measurement results
- Strong filtering, e.g. for the detection of bulk materials or for the best possible accuracy
- No filtering, e.g. for the detection of fast moving objects
- Setting via IO-Link

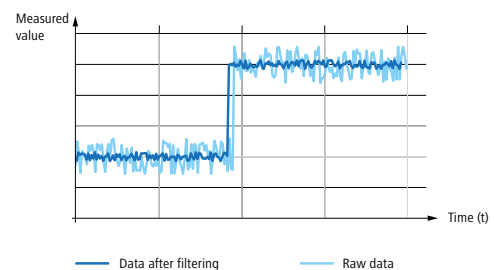

## Configurable switching output

- Parameterization of the hysteresis (difference between switching point and reset point), adjustable via IO-Link
- Setting of the switching behavior (NO or NC) via IO-Link and *qTeach*®

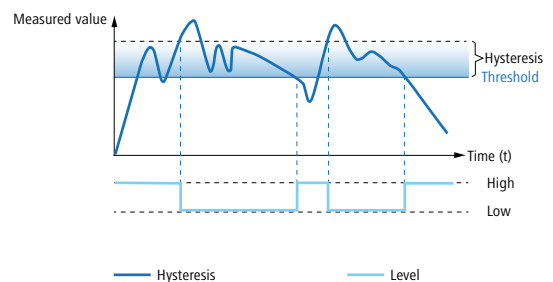

## Limitless options in plant design

- Identical functions in both cubic and cylindrical designs
- Sensor properties can be set directly on the sensor (*qTeach*®) or remotely via the PLC system (IO-Link)
- The UR18 has a standard thread in stainless steel
- The dimensions and operating elements of the U500 are identical to the optical counterpart O500

# Added value of IO-Link in the application

## Complete and intuitive parameterization of the sonic beam width

Achieve optimum results with a narrow sonic beam through a narrow opening or with a wide sonic beam for reliable detection of the presence of parts, e.g. in the parts bunker.



## Parameter adjustment of several sensors before delivery

Do you use the same sensor in different machine types in your production? The teach-by-value function of IO-Link allows you to set the switching points without having to put the machine into operation.

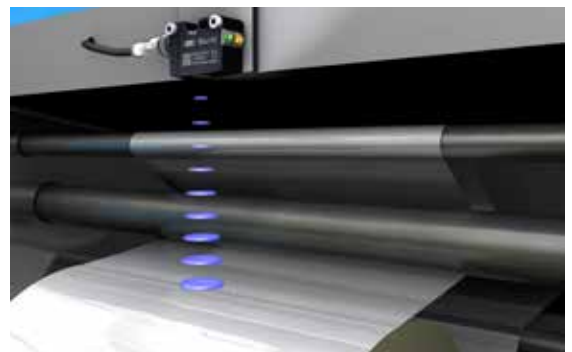

## Individual setting of the sensor functions

Easily detect transparent objects such as bottles. With ultrasonic sensors from Baumer you can detect the filling level of the bottle table and control the system accordingly. The adjustable filter function allows you to find the optimal balance between speed and stability of the measuring signal.

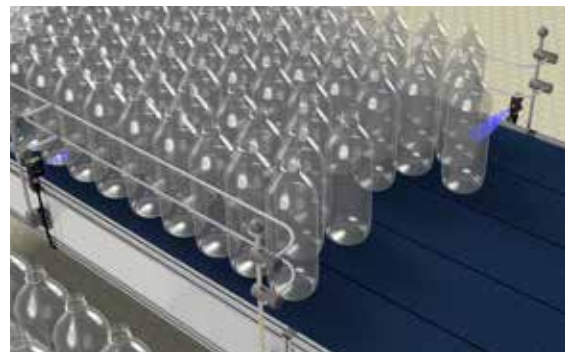

## Advantages of ultrasonic sensors with IO-Link

- Complete parameter adjustment of the sensor on site with intuitive user interface, e.g. adjustment of the sonic beam width depending on the vessel opening and filling medium.
- Use additional data effectively e.g. distance signal even with a switching sensor, object counting to assess machine efficiency or predictive maintenance planning by recording temperature data and operating times.
- Individual setting of the sensor properties, e.g. configuration of the behaviour of the output signals or LEDs. Multipurpose Pin 5 can be activated for synchronization.
- Parameter server functions enable simple and fast sensor exchange and multiplication of parameter data.

# Sensor principles

## Proximity switches (1-point or 2-point)

- Detection of an object in the detection range and output as a switching signal or as a digital distance value via IO-Link
- Also available as 2-point switch (Dual Channel) with independent outputs, ideal for level measurements
- Application: Object detection on conveyor belts or presence detection

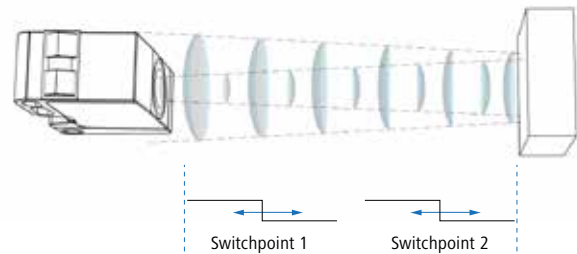

## Retro-reflective sensors

- Detection of an object between a sensor and a fixed reflector
- Absolutely reliable detection without blind range
- Application: For sonic-absorbing and sonic-deflecting objects

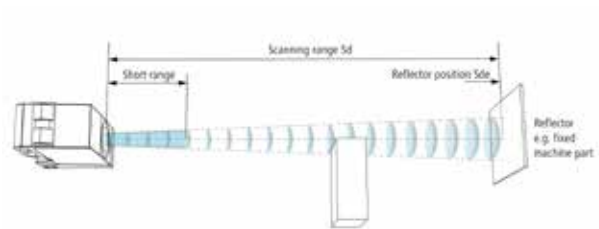

## Through beam sensors

- Detection of an object between a separate transmitter and receiver unit
- Short response times and long ranges
- Application: Detection and counting of fast consecutive objects over long distances and double sheet detection

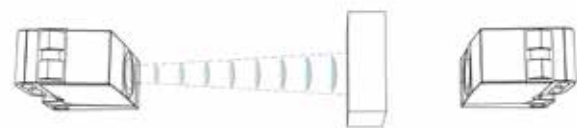

## Distance sensors

- Distance measurement from sensor to object and output as analog or digital measured value
- Enables precise process control even in difficult environments and on uneven surfaces such as granules
- Application: Level measurement, determination of roll diameters and stack heights



Continuous analog measured value

Learn more about the different sensor principles:  
[www.baumer.com/functionality-ultrasonic](http://www.baumer.com/functionality-ultrasonic)

# Product portfolio U500 and UR18

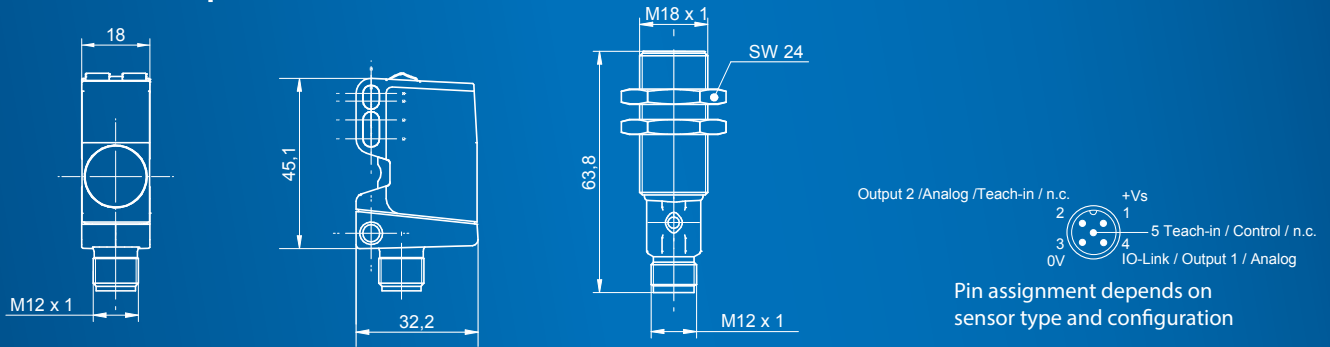

Pin assignment depends on sensor type and configuration

Sensor principle	Output	Measuring range	Order designation U500	Order designation UR18
1-point proximity switch	IO-Link	20 ... 1000	U500.PA0.2-11200632	UR18.P-11200644
2-point proximity switch (Dual Channel)	IO-Link, 2 switching outputs	20 ... 1000	U500.PA0.2-11200633	UR18.P-11200645
Retro-reflective sensor	IO-Link, 1 switching output	0 ... 1000	U500.RA0.2-11200634	UR18.R-11200646
Through beam sensor	IO-Link, 2 switching output	0 ... 2000	U500.EB0.2-11228075 U500.TB0.2-11200636	UR18.E-11228073 UR18.T-11200648
Distance measuring sensor	IO-Link, switching output and analog output independently of each other	20 ... 1000	U500.DA0.2-11200623 (U) U500.DA0.2-11200625 (I)	UR18.D-11200639 (U) UR18.D-11200640 (I)
Distance measuring sensor retro fit	Pin assignment same as the previous version	20 ... 1000	U500.DA0.2-11200629 (U) U500.DA0.2-11200630 (I)	UR18.D-11200641 (U) UR18.D-11200642 (I)

## Accessories



USB and wireless IO-Link master  
Part no. 11048016, 11214576



Sensofix mounting bracket  
Part no. 11099942



Mounting bracket L-shape  
Part no. 11092246



Mounting bracket \*  
Part no. 11111164



Sound deflection angle (only for U500)  
Part no. 11111163

\*To replace the UNDK 30. Mounting and connection accessories at [www.baumer.com/accessories-sensors](http://www.baumer.com/accessories-sensors)



More information about our ultrasonic sensors U500 and UR18 can be found at: [www.baumer.com/robust-ultrasonic-sensors](http://www.baumer.com/robust-ultrasonic-sensors)

Find your local partner: [www.baumer.com/worldwide](http://www.baumer.com/worldwide)



Baumer Group  
International Sales  
P.O. Box · Hummelstrasse 17 · CH-8501 Frauenfeld  
Phone +41 (0)52 728 1122 · Fax +41 (0)52 728 1144  
[sales@baumer.com](mailto:sales@baumer.com) · [www.baumer.com](http://www.baumer.com)