

Thank you very much for purchasing Panasonic products. Read this Instruction Manual carefully and thoroughly for the correct and optimum use of this product. Kindly keep this manual in a convenient place for quick reference.

⚠ WARNING

- Never use this product as a sensing device for personnel protection.
- In case of using sensing devices for personnel protection, use products which meet laws and standards, such as OSHA, ANSI or IEC etc., for personnel protection applicable in each region or country.

1 PART DESCRIPTION

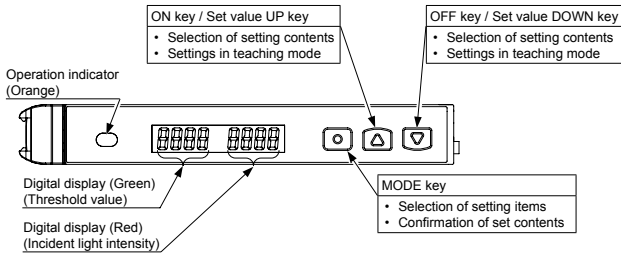

2 MOUNTING

<When using a DIN rail>

How to mount the amplifier

1. Fit the rear part of the mounting section of the amplifier on DIN rail.
2. Press down the rear part of the mounting section of the unit on the DIN rail and fit the front part of the mounting section to the DIN rail.

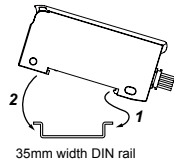

How to remove the amplifier

1. Push the amplifier forward.
2. Lift up the front part of the amplifier to remove it.

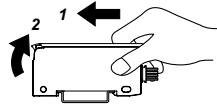

Notes: Take care that if the front part is lifted without pushing the amplifier forward, the hook on the rear portion of the mounting section is likely to break.

<When using screws with washers>

- Use M3 screws with washers for mounting. The tightening torque should be 0.5N·m or less.

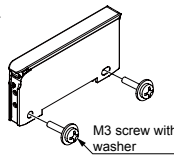

How to connect the fiber cable

Be sure to fit the attachment to the fibers first before inserting the fibers to the amplifier. For details, refer to the Instruction Manual enclosed with the fibers.

1. In cover open condition, snap the fiber lock lever down, till it stops completely.
2. Insert the fiber cables slowly into the inlets until they stop. (Note 1)
3. Return the fiber lock lever to the original position, till it stops.

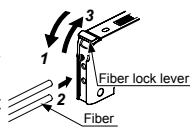

Notes: 1) In case the fiber cables are not inserted to a position where they stop, the sensing range reduces. Since a flexible fiber is easily bent, take care when it is inserted.

2) With the coaxial reflective type fiber, such as, **FD-42G** or **FD-61G**, insert the single-core fiber cable into the beam-emitting inlet "P" and the multi-core fiber cable into the beam-receiving inlet "D." If they are inserted in reverse, the sensing performance will deteriorate.

3 WIRING

Connection method

- Insert the cable with connector **CN-14A-C** into this product's connector area as shown in the right figure.

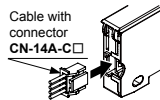

Disconnection method

- Pressing the release lever of the cable with connector, pull out the connector.

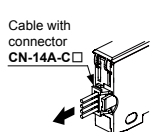

Note: Take care that if the connector is pulled out without pressing the release lever, cable or connector may break.

<Connector pin arrangement>

Connector pin No.	Terminal name
1	+V
2	Output
3	External input
4	0V

4 I/O CIRCUIT DIAGRAMS

NPN output type

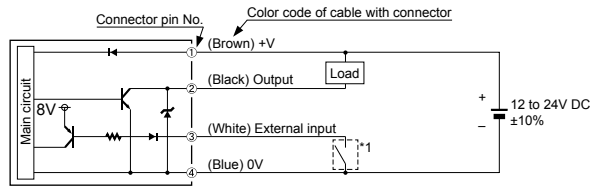

PNP output type

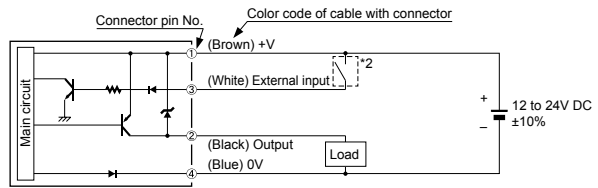

*1 Non-voltage contact or NPN open-collector transistor

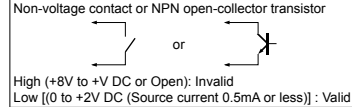

*2 Non-voltage contact or PNP open-collector transistor

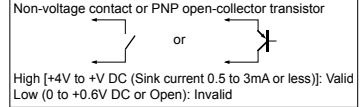

5 RUN MODE

<Digital display>

- When turning ON the power, the product name is indicated on the green digital display, while the emission frequency is indicated on the red digital display. Then switch-into RUN mode [digital display (green: threshold value, red: incident light intensity)].

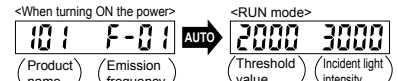

- When selecting emission halt in the external input setting mode and receiving the signal externally, "E-oF" is indicated on the red digital display.
- When selecting ECO in the external input setting mode, key operation on the main body is invalid during external input.
- When selecting 2-point teaching in the external input setting mode, "2-Pl" is indicated on the green digital display after inputting the first point.
- When ECO setting mode is ON, the digital display turns off in approx. 20 sec. In case of lighting up the digital display again, press any key for 2 sec. or more.
- For the settings of external input and ECO, refer to "8 PRO MODE."

Threshold value fine adjustment function

- Fine adjustment of threshold value can be done when in RUN mode.
- Press the set value UP key or set value DOWN key to change threshold value. (Hold down the key to make the value change faster.)
- The threshold value is stored after 3 sec.

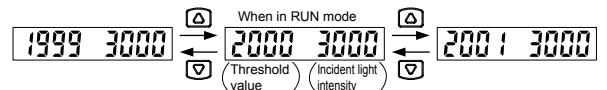

Keylock function

- The keylock function prevents key operations so that the conditions set in each setting mode are not inadvertently changed.
- In the keylock condition, "Loc on" is displayed when pressing any key.

<Keylock set>

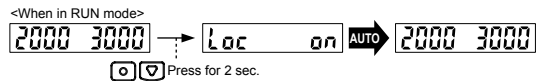

<Keylock released>

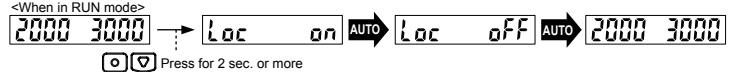

6 SETTING MODE

- Setting mode appears after pressing **MODE key for 2 sec. in RUN mode.**
- RUN mode appears when **MODE key** is pressed for 2 sec. while setting and the changed contents have been set.
- Make sure to return to RUN mode before turning OFF the power. If the power is turned OFF while setting, the changed contents have not been set.

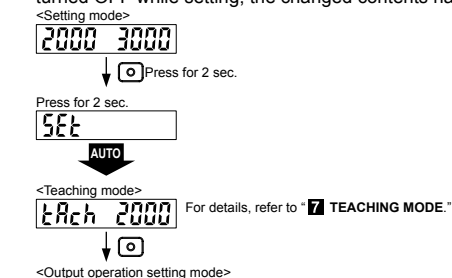

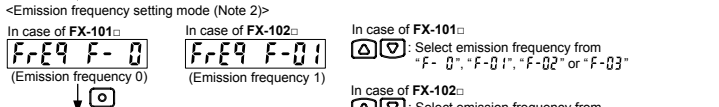
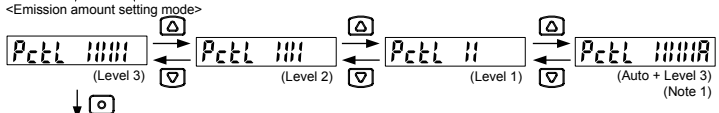
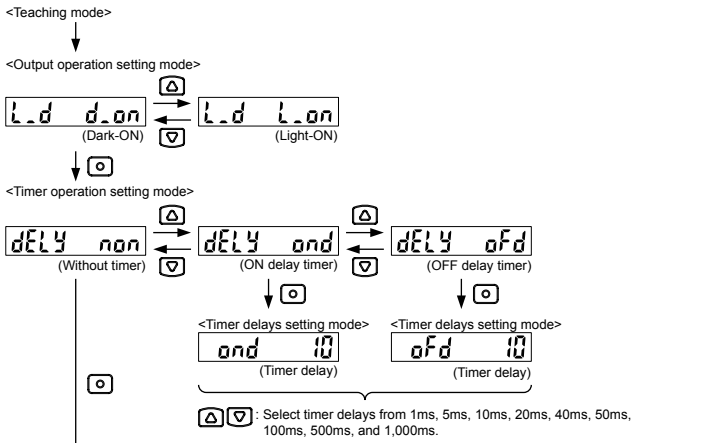

<RUN mode>

2000 3000

Notes: 1) When selecting Auto (displayed with "R"), proper light intensity ("1000R", "100R" or "10R") is automatically decided when only the limit teaching is set. ("1000R" is indicated at first selecting.) In Auto, emission amount is automatically set to let the incident light intensity in proper range (1000 to 3800).
 2) The operation indicator and the beam-emitting inlet blink while setting emission frequency. (When emission frequency 0 is set, they light up.) The blinking cycle depends on each emission frequency. (Emission frequency 1: fast ↔ Emission frequency 4: slow)

Setting item	Factory setting	Description
Teaching mode	LRch	Threshold value can be set in 2-point teaching, limit teaching or full-auto teaching. For details, refer to 7 TEACHING MODE .
Output operation setting mode	L_d d_on	Light-ON or Dark-ON can be set.
Timer operation setting mode	dELY non	Without timer, ON delay timer or OFF delay timer can be set.
Timer delays setting mode	ond 10 ofd 10	When setting ON delay timer or OFF delay timer in the timer operation setting mode, timer delays can be set. • When timer is not set, this mode is not displayed.
Emission amount setting mode	PcTL 1000	In case incident light intensity is saturated, emission amount can be reduced. The reduced intensity state can also be released. Level 3 "1000R": Normal emission amount level Level 2 "100R": Emission amount level 3 × approx. 40% Level 1 "10R": Emission amount level 3 × approx. 20% When selecting Auto, displayed with "R." Only in the limit teaching, proper light intensity is automatically set.
Emission frequency setting mode	FX-101: FrEQ F-0 FX-102: FrEQ F-01	When using the fiber heads in parallel, interference can be prevented by setting different emission frequency. However, when emission frequency 0 is set, interference cannot be prevented. Response time corresponds to emission frequency. For details, refer to 4 SPECIFICATIONS .

7 TEACHING MODE

Make sure that detection may become unstable if less margin is applied in the use environment when teaching.

In case of 2-point teaching

- This is the method of setting the threshold value by teaching two points, corresponding to object present and object absent conditions. Normally, setting is done by this method.
- The output operation setting of Light-ON or Dark-ON is reflected automatically.

<For output ON when in object present condition>

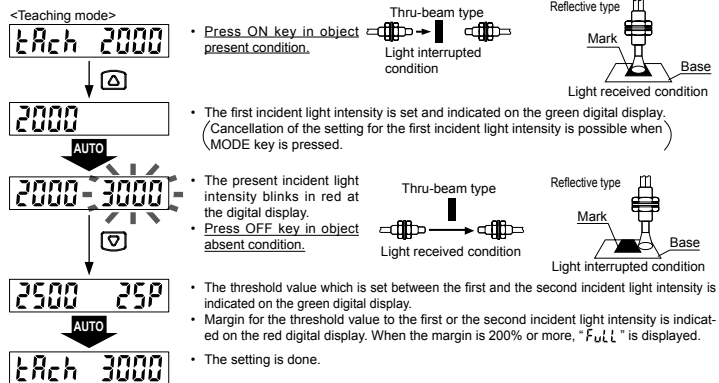

<For output ON when in object absent condition>

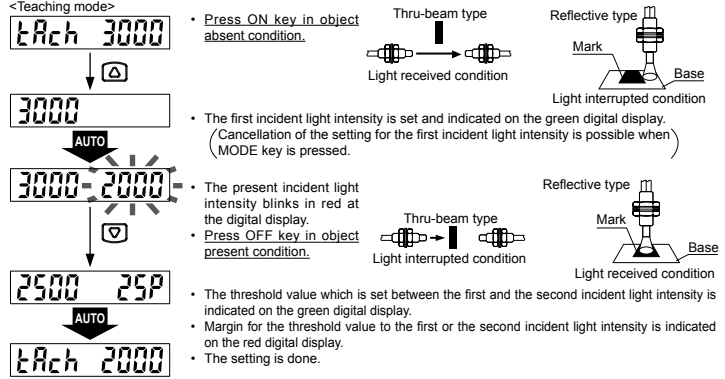

In case of limit teaching

- This is the method of setting the threshold value by teaching only the object absent condition (stable incident light condition). This is used for detection in the presence of a background body or for detection of small objects.
- When selecting "Auto" (displayed with "R") in the emission amount setting mode, proper light intensity can be automatically set. For the setting method, refer to **6 SETTING MODE**.

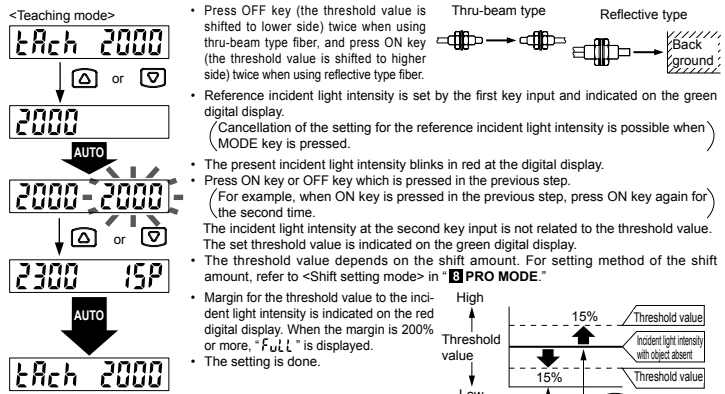

In case of full-auto teaching

- Full-auto teaching is used when it is desired to set the threshold value without stopping the assembly line, with the object in the moving condition.

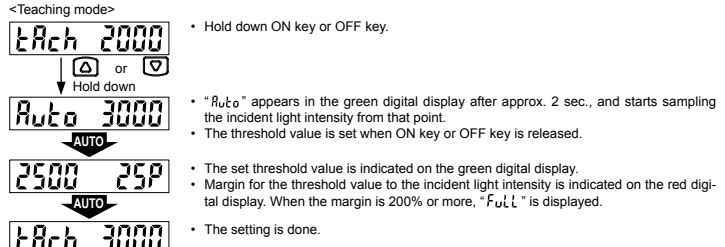

8 PRO MODE

- PRO mode appears after pressing MODE key for 4 sec. in RUN mode.
- RUN mode appears when MODE key is pressed for 2 sec. while setting and the changed contents have been set.
- Make sure to return to RUN mode before turning OFF the power. If the power is turned OFF while setting, the changed contents have not been set.

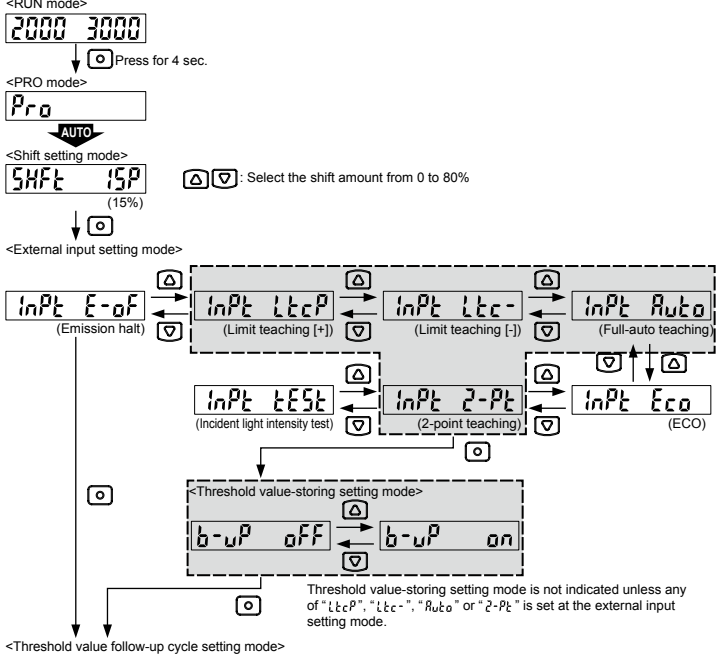

<External input setting mode>

<Threshold value follow-up cycle setting mode>

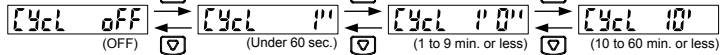

<GETA function setting mode>

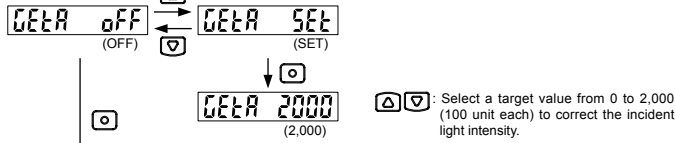

<ECO setting mode>



<Inverting digital display setting mode>



<Threshold value margin setting mode>



Alert output of external input teaching does not operate unless any of "ltp", "ltc-", "Aut" or "2-pt" is set at the external input setting mode.

<Setting copy mode>



<Reset mode>

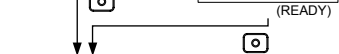

<RUN mode>

2000 3000

Setting item	Factory setting	Description
Shift setting mode	SHft 15P	Shift amount can be selected from 0 to 80% in the limit teaching. Select 0% when it is desired to set the present incident light intensity as a threshold value.
External input setting mode	INpt E-oF	External input can be selected from emission halt, limit teaching [+], limit teaching [-], full-auto teaching, ECO (Note 1), 2-point teaching or emission amount test. When setting the incident light intensity test "ltp", output turns ON / OFF every 100ms when the rate of incident light intensity and threshold value is less than half of the set shift amount (for example, when the rate of incident light intensity and threshold value is within ±10% for 20% of shift amount) at external input.
Threshold value-storing setting mode (Note 2)	b-wP OFF	Threshold value set at the limit teaching, full-auto teaching or 2-point teaching by external input is stored. When selecting Auto in the emission amount setting mode, the set emission amount level is also stored.
Threshold value follow-up cycle setting mode (Note 3)	CYcl OFF	When incident light intensity exceeds threshold value, this mode can change the threshold value with each set cycle depending on variations of the incident light intensity. The follow-up shift amount is same as the one set in the shift setting mode. However, the threshold value is not stored.
GETA function setting mode (Note 4, 5)	GETA OFF	Variations can be reduced by correcting the present incident light intensity in each amplifier to a target value. Target value to offset incident light intensity can be selected from 0 to 2,000 by 100 unit each. For example, if the target value is set to 2,000 when the incident light intensity is 1,500, the incident light intensity becomes 2,000.
ECO setting mode	Eco OFF	It is possible to light up / turn off the digital display. When ECO setting mode is ON, the display turns off in approx. 20 sec. in RUN mode. To light up the display again, press any key for 2 sec. or more.
Inverting digital display setting mode	turn OFF	Digital display can be inverted.
Threshold value margin setting mode	ALrt OFF	Margin for threshold value to the present incident light intensity can be checked. When there is no margin, it is possible to make the digital display blink. "GRn": Green blinks. "rEd": Red blinks. "ALL": Red and Green blink. "IN-t": When conducting limit teaching or 2-point teaching by external input, in case the rate of reference incident light intensity and threshold value after teaching is 200% or more, or in case it is less than half of the shift amount, output turns ON / OFF every 100ms. (Note 6)
Setting copy mode	COPY NO	The settings of the master side amplifier can be copied to the slave side amplifier. For details, refer to "10 SETTING COPY FUNCTION."
Reset mode	rSet NO	Returns to default settings (factory settings).

- Notes: 1) When ECO is selected at the external input setting mode, key operation on the main body is invalid during external input.
 2) This mode is not indicated unless any of "ltp", "ltc-", "Aut" or "2-pt" is set at the external input setting mode.
 3) If the incident light intensity becomes "300" or less, the follow-up operation stops. In that condition, threshold value [digital display (green)] blinks. This function can be used when thru-beam type or retroreflective type fiber is applied to this product. If reflective type fiber is applied, the function cannot be used depending on use conditions.
 4) If pressing MODE key in RUN mode when GETA function is used, the incident light intensity before setting GETA function is displayed on the red digital display for approx. 2 sec.
 5) When GETA function is used in saturation of incident light intensity (4,000 or more), "Hrd" is indicated on the red digital display. Correction value is up to 4,000.)
 6) This mode does not operate unless any of "ltp", "ltc-" or "2-pt" is set at the external input setting mode.

9 EXTERNAL INPUT SETTING

- When selecting emission halt in the external input setting mode and receiving the signal externally, "E-oF" is indicated on the red digital display.
- When selecting ECO in the external input setting mode, key operation on the main body is invalid during external input.
- When selecting 2-point teaching in the external input setting mode, "2-pt" is indicated on the green digital display after inputting the first point.
- For the setting of external input, refer to "8 PRO MODE."

<Time chart when setting external input>

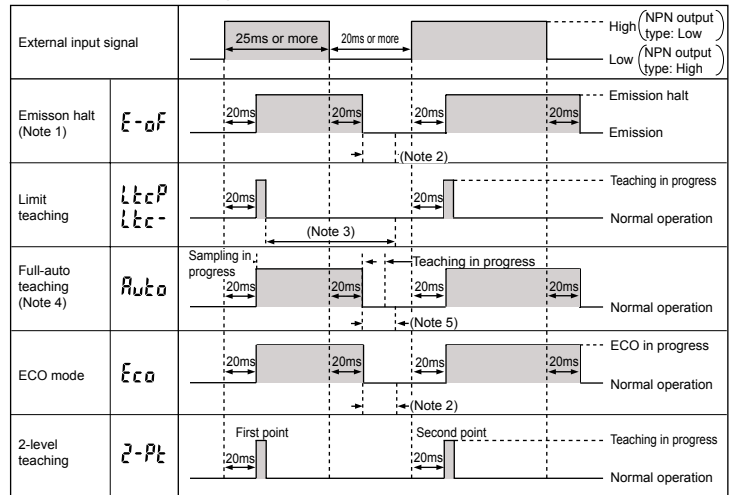

- Notes: 1) Output may turn ON / OFF when emission is halted or is released depending on setting of threshold value.
 2) When emission starts, output operation will be undetermined only during the response time. If the output signal is received by something such as a PLC, set the timer to a value of 20ms amplifier response time or greater. Example: For the FX-101 with emission frequency 0 (response time 250µs or less) Timer period: 20ms + 0.25ms (250µs) = 20.25ms
 3) After teaching is complete, output operation will be undetermined only during the response time. If the output signal is received by something such as a PLC, set the timer to the amplifier response time or greater. The threshold value will be set based on the incident light intensity at the instant when teaching is verified.
 4) Move the sensing object past once during the time that the external input signal is being input.
 5) After teaching is complete, output operation will be undetermined only during the response time. If the output signal is received by something such as a PLC, set the timer to the amplifier response time or greater.

<Alert output of external input teaching>

- When conducting limit teaching or 2-point teaching by external input, if the alert output of external input teaching "IN-t" is set in the threshold value margin setting mode, output turns ON / OFF every 100ms in case the rate of reference incident light intensity and threshold value after teaching is 200% or more, or in case it is less than half of the shift amount. For the setting method, refer to <Threshold value margin setting mode> under "8 PRO MODE."

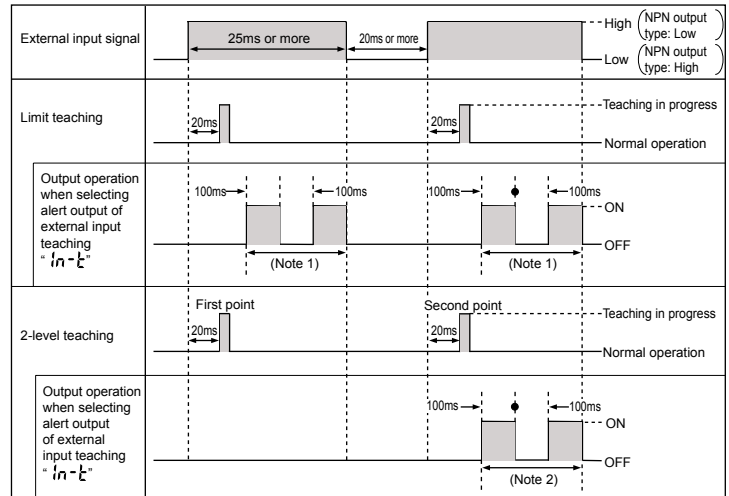

- Notes: 1) In case the margin is no good, output turns ON / OFF every 100ms during the time that the external input signal is being input after teaching.
 2) In case the margin is no good, output turns ON / OFF every 100ms during the time that the external input signal is being input after the second teaching.

10 SETTING COPY FUNCTION

- This can copy the settings of the master side amplifier to the slave side amplifier.
- Be sure to use the setting copy function between the identical models. This function cannot be used between different models.
- Only one sensor can be connected on slave side with a master side sensor for the setting copy function.
- Threshold value, output operation setting, timer operation setting, timer setting, emission amount setting, shift setting, external input setting, threshold value-storing setting, ECO setting, inverting digital display setting, and threshold value margin setting can be copied.

Setting procedures

- Set the setting copy mode of the master side amplifier to "Copy sending ON," and press MODE key so that "COPY rEdY" is shown on the digital display and the sensor is in copy ready state. For the setting method, refer to <Setting copy mode> in "8 PRO MODE."
- Turn off the master side amplifier.
- Connect the master side amplifier with the slave side amplifier as shown below.

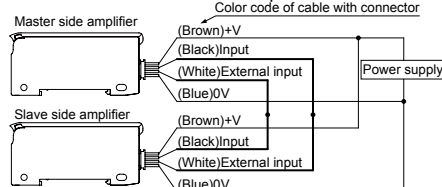

- Turn on the master side amplifier and the slave side amplifier at the same time. (Note)
 - "COPY" is shown on the green digital display of the master side amplifier and 4-digit code is shown on the red digital display of it, then the copying starts.
 - When the copying is completed, "Good" is shown on the green digital display of the slave side amplifier, while the 4-digit code (the same code as the master side amplifier) is shown on the red digital display of it.
 - Turn off the power of the master side amplifier and the slave side amplifier and disconnect the wire.
- * If copying the settings to another amplifier repeatedly, follow the steps 3 to 7.

Note: Take care that if the power is not turned on at the same time, the setting contents may not be copied.

To cancel the setting copy mode of the master side amplifier

- While the slave side amplifier is disconnected, turn on the power of the master side amplifier.
- Press MODE key for approx. 2 sec.

11 QUICK SETTING FUNCTION

- Simply by selecting a setting number, output operation, emission amount, timer, and emission frequency can be set.
- For the setting numbers, refer to <Table of quick setting numbers>.
- Make sure to return to RUN mode before turning OFF the power. If the power is turned OFF while setting, the changed contents have not been set.

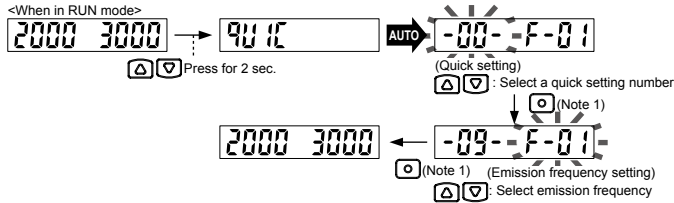

- Notes: 1) Cancellation is possible when pressing MODE key for 2 sec. or more before finalizing, then returns to RUN mode.
2) When the present setting is out of the quick setting range, "-88-" is shown. When "-88-" is selected, the set content is not changing.

<Table of quick setting numbers>

No.	Output operation	Emission amount setting	Timer	No.	Output operation	Emission amount setting	Timer
-00-	D-ON	Level 3	non	-10-	L-ON	Level 2	ond 40ms
-01-	D-ON	Level 2	non	-11-	L-ON	Level 3	ond 40ms
-02-	D-ON	Level 3	ofd 10ms	-12-	L-ON	Level 2	ond 10ms
-03-	D-ON	Level 2	ofd 10ms	-13-	L-ON	Level 3	ond 10ms
-04-	D-ON	Level 3	ofd 40ms	-14-	L-ON	Level 2	ofd 40ms
-05-	D-ON	Level 2	ofd 40ms	-15-	L-ON	Level 3	ofd 40ms
-06-	D-ON	Level 3	ond 10ms	-16-	L-ON	Level 2	ofd 10ms
-07-	D-ON	Level 2	ond 10ms	-17-	L-ON	Level 3	ofd 10ms
-08-	D-ON	Level 3	ond 40ms	-18-	L-ON	Level 2	non
-09-	D-ON	Level 2	ond 40ms	-19-	L-ON	Level 3	non

12 CODE SETTING FUNCTION

- By selecting codes arbitrarily, output operation, timer, emission amount, emission frequency, ECO, external input, and shift amount can be set.
- For the codes, refer to <Code table>.
- Make sure to return to RUN mode before turning OFF the power. If the power is turned OFF while setting, the changed contents have not been set.

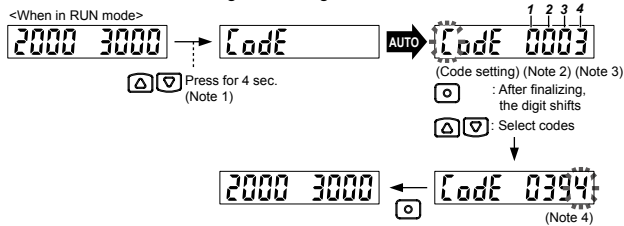

- Notes: 1) Although the quick setting function appears 2 sec. after the set value UP key and set value DOWN key are pressed, keep pressing the key.
2) Cancellation is possible when MODE key is pressed for 2 sec. or more before the digit blinks, then returns to RUN mode.
3) Cancellation of set value is possible when MODE key is pressed for 2 sec. or more while the digit is blinking.
4) When the fourth digit is determined, the settings are reflected.

<Code table>

Code	1st digit		Emission amount setting	2nd digit		ECO	External input	Shift (Note 5)	
	Output operation	Timer (Note 5)		Emission frequency					
0	D-on	non	Level 3	FX-101	FX-102	OFF	Emission halt	5%	
1		ond 10ms		0	1		Limit teaching [+]	10%	
2		ond 40ms		1	2		Limit teaching [-]	15%	
3		ofd 10ms	2	3	Full-auto teaching		20%		
4		ofd 40ms	3	4	ECO		25%		
5		non	Level 2	0	1		Emission halt	30%	
6		ond 10ms		1	2		Limit teaching [+]	35%	
7		ond 40ms		2	3		Limit teaching [-]	40%	
8		L-on	ofd 10ms	3	4		Full-auto teaching	45%	
9	ofd 40ms		0	1	ECO	50%			
A	ofd 40ms		1	2					
b	Auto		Level 1	2	3	OFF	2-level teaching		
c				3	4		Incident light intensity test		
d			Auto	0	1		ON	2-level teaching	
e				1	2			Incident light intensity test	
F				2	3				
				3	4				

- Notes: 5) When the present setting is out of the code setting range, "-" is shown. When "-" is selected, the set content of the digit is not changed.
6) The factory setting is "0002".

13 ERROR INDICATION

- In case of errors, attempt the following measures.

Display	Error description	Measures
Er-0	EEPROM writing error	Contact our office.
Er-1	The load has short-circuited and excess current is flowing.	Turn off the power, then check the load.
Er-5	Communication error (Disconnection, connection failure, etc.)	Check the wiring before using the setting copy function.

14 SPECIFICATIONS

Model No. (Note 1)	Type	Standard		Long sensing range	
		FX-101	FX-101-CC2	FX-102	FX-102-CC2
Item	PNP output	FX-101P	FX-101P-CC2	FX-102P	FX-102P-CC2
Supply voltage		12 to 24V DC±10% Ripple P-P 10% or less (within the rated range)			
Power consumption		Normal operation: 720mW or less (Current consumption 30mA or less at 24V supply voltage) ECO mode: 600mW or less (Current consumption 25mA or less at 24V supply voltage)			
Output		<NPN output type> NPN open-collector transistor · Maximum sink current: 100mA · Applied voltage: 30V DC or less (between output and 0V) · Residual voltage: 1.5V or less (at 100mA sink current)		<PNP output type> PNP open-collector transistor · Maximum source current: 100mA · Applied voltage: 30V DC or less (between output and +V) · Residual voltage: 1.5V or less (at 100mA source current)	
Output operation		Light-ON or Dark-ON, selectable			
Short-circuit protection		Incorporated			
External input		<NPN output type> NPN non-contact input · Signal condition High: +8V to +V DC or Open Low: 0 to +2V DC (Source current 0.5mA or less) · Input impedance: Approx. 10kΩ		<PNP output type> PNP non-contact input · Signal condition High: +4V to +V DC (Sink current 0.5 to 3mA or less) Low: 0 to +0.6V DC or Open · Input impedance: Approx. 10kΩ	
Response time		Emission frequency 0: 250µs or less Emission frequency 1: 450µs or less Emission frequency 2: 500µs or less Emission frequency 3: 600µs or less		Emission frequency 1: 2.5ms or less Emission frequency 2: 2.8ms or less Emission frequency 3: 3.2ms or less Emission frequency 4: 5.0ms or less	
Ambient temperature		-10 to +55°C (No dew condensation or icing allowed) (Note 2), Storage: -20 to +70°C			
Ambient humidity		35 to 85% RH, Storage: 35 to 85% RH			
Emitting element		Red LED (peak wavelength = 632nm)			
Material		Enclosure and the cover: Polycarbonate, Fiber lock lever: PBT			
Weight		Approx. 15g (Main body only)			
Accessory		CN-14A-C2 (Cable with connector, 2m long) (-CC2 type only): 1pc.			

- Notes: 1) Cable with connector CN-14A-C2 is not enclosed with models that have no suffix "-CC2" with the model Nos. Make sure to use the optional cable with connector CN-14A-C2, or a connector (contact: SPHD-001T-P0.5, housing: PAP-04V-S) manufactured by JST Mfg. Co., Ltd.
2) When using the products in parallel, the ambient temperature is as follows.
4 to 7 units: -10 to +50°C, 8 to 16 units: -10 to +45°C

15 CAUTIONS

- This product has been developed / produced for industrial use only.
- Make sure that the power supply is off while wiring.
- Take care that if a voltage exceeding the rated range is applied, or if an AC power supply is directly connected, the product may get burnt or damaged.
- Take care that short-circuit of the load or wrong wiring may burn or damage the product.
- Do not run the wires together with high-voltage lines or power lines or put them in the same raceway. This can cause malfunction due to induction.
- Verify that the supply voltage variation is within the rating.
- If power is supplied from a commercial switching regulator, ensure that the frame ground (F.G.) terminal of the power supply is connected to an actual ground.
- In case noise generating equipment (switching regulator, inverter motor, etc.) is used in the vicinity of this product, connect the frame ground (F.G.) terminal of the equipment to an actual ground.
- Do not use during the initial transient time (0.5 sec.) after the power supply is switched on.
- Extension up to total 100m is possible with 0.3mm², or more, cable. However, in order to reduce noise, make the wiring as short as possible.
- Make sure that stress by forcible bend or pulling is not applied to the sensor cable joint.
- Take care that the product is not directly exposed to fluorescent lamp from a rapid-starter lamp, a high frequency lighting device or sunlight etc., as it may affect the sensing performance.
- This product is suitable for indoor use only.
- Avoid dust, dirt, and steam.
- Take care that the product does not come in contact with oil, grease, organic solvents, such as thinner, etc., strong acid or alkaline.
- This product cannot be used in an environment containing inflammable or explosive gases.
- Never disassemble or modify the product.
- EEPROM is adopted to this product. It is not possible to conduct teaching 100 thousand times or more, because of the EEPROM's lifetime.

16 APPLICABLE STANDARD/REGULATIONS

- This product complies with the following standards / regulations.
<EU Directive>
EMC Directive 2004/108/EC
<Standards in US / Canada>
ANSI/UL 60947-5-2, CAN/CSA C22.2 No. 14
- Caution about UL recognition
In case requiring conformity of UL listing mark or C-UL listing mark, use class 2 power supply unit.
- Contact for CE
<Until June 30, 2013>
Panasonic Electric Works Europe AG
Rudolf-Diesel-Ring 2, D-83607 Holzkirchen, Germany
<From July 1, 2013>
Panasonic Marketing Europe GmbH Panasonic Testing Center
Winsbergring 15, 22525 Hamburg, Germany



Panasonic Industrial Devices SUNX Co., Ltd.

http://panasonic.net/id/pidsx/global

Overseas Sales Division (Head Office)
2431-1 Ushiyama-cho, Kasugai-shi, Aichi, 486-0901, Japan
Phone: +81-568-33-7861 FAX: +81-568-33-8591

About our sale network, please visit our website.

PRINTED IN CHINA

© Panasonic Industrial Devices SUNX Co., Ltd. 2012