

UC-2100 Series

Arm Cortex-A8 600 MHz palm-sized IIoT gateways with 1 mini PCIe expansion slot for a wireless module



Features and Benefits

- Armv7 Cortex-A8 600-1000 MHz processor
- Palm-sized form factor, 50 x 80 x 28 mm
- Moxa Industrial Linux with 10-year superior long-term support
- MXview support for centralized monitoring of devices and computing status
- Unified APIs and push-based communication for retrieving data only when needed
- 1 or 2 auto-sensing 10/100 Mbps Ethernet ports
- Gigabit Ethernet supported (UC-2112)
- Up to 2 software-selectable RS-232/422/485 ports supporting all signals
- Mini PCIe socket for Wi-Fi/cellular module (UC-2104)
- -40 to 75°C wide-temperature model available with hazardous locations certification

Certifications



Introduction

The UC-2100 Series computing platform is designed for embedded data acquisition and processing applications. The computer comes with up to two software selectable RS-232/422/485 full-signal serial ports and single or dual Ethernet ports. This palm-sized series of Arm-based computing platforms includes a variety of models for a wide range of interface requirements, such as single or dual serial and Ethernet ports, Gigabit Ethernet, and wireless connections. These versatile communication capabilities allow users to efficiently adapt the UC-2100 for a variety of complex communications solutions.

The UC-2100 Series has a built-in Cortex-A8 Arm-based processor that has been optimized for a variety of industrial solutions. With its flexible interface options, this tiny embedded computer is a reliable and secure gateway for data acquisition and processing at field sites and is a useful communication platform for many other large-scale deployments. Models designed for wide temperature applications are available for use in extreme environments such as those found in the oil and gas industry. Furthermore, all models use the Moxa Industrial Linux platform, which provides optimized software features and long-term support.

Appearance

UC-2101

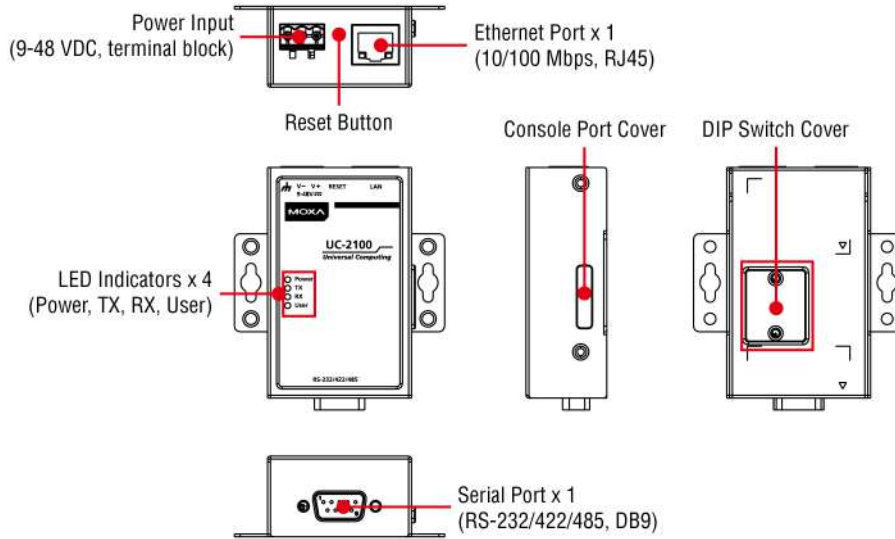

UC-2102

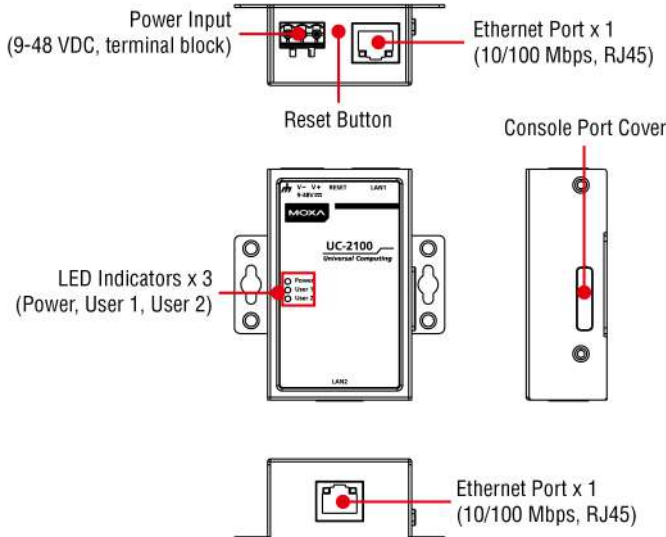

UC-2104

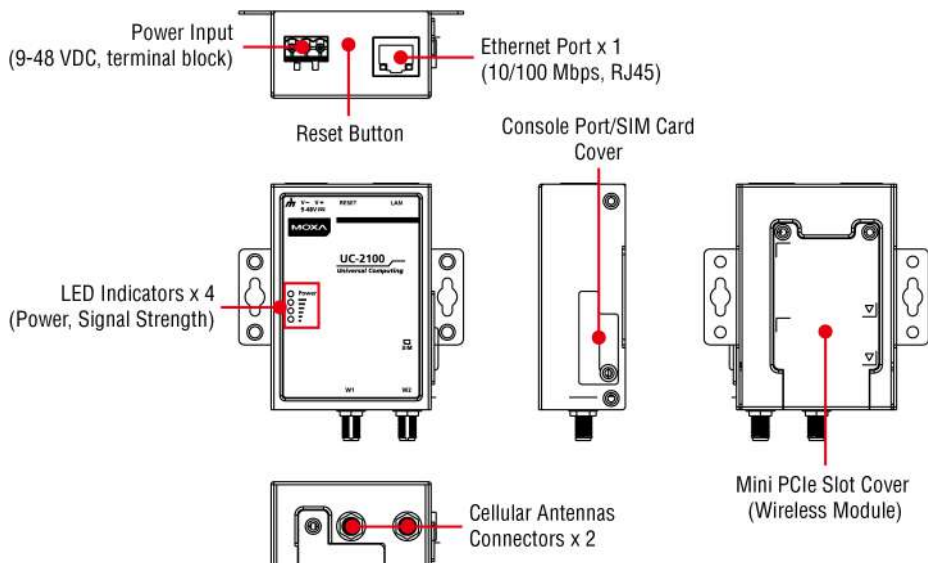

UC-2111

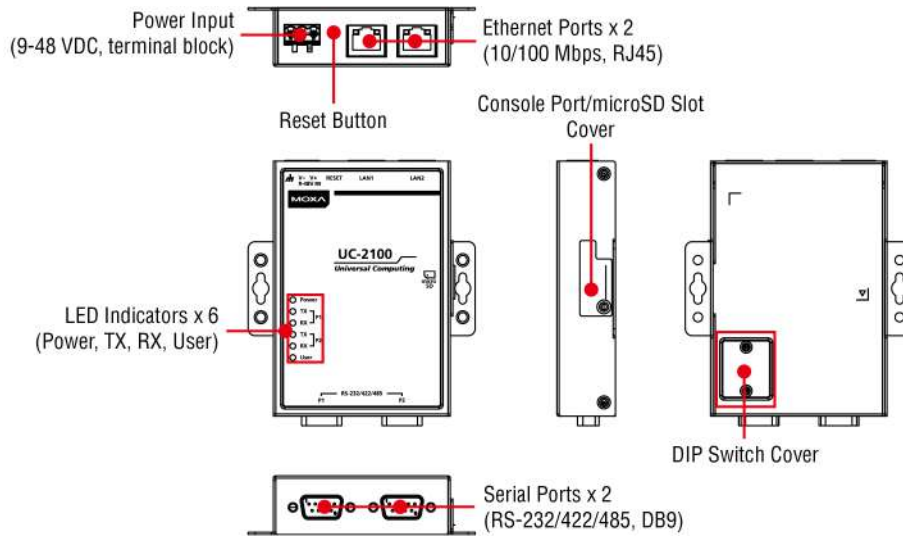

UC-2112

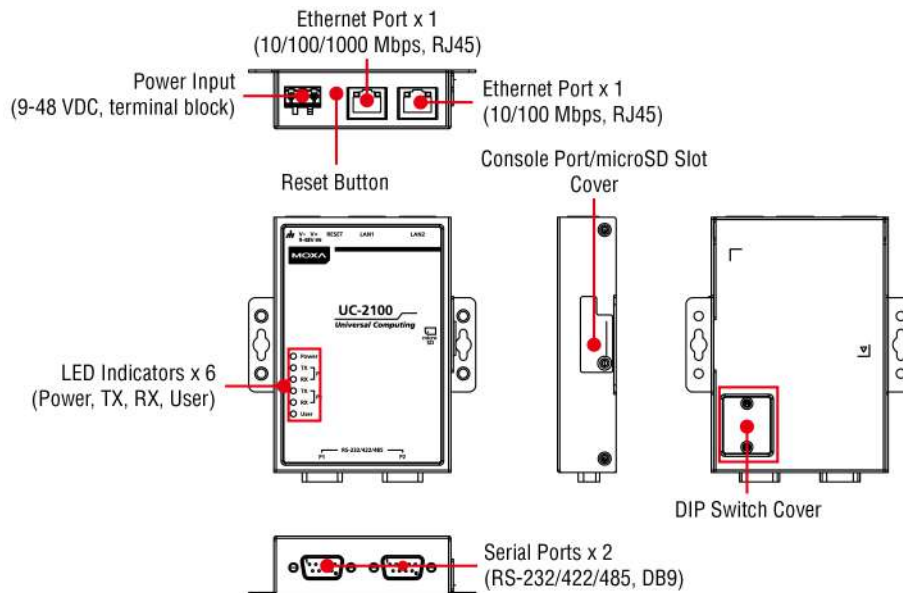

Specifications

Computer

CPU	UC-2101-LX: Armv7 Cortex-A8 600 MHz UC-2102-LX: Armv7 Cortex-A8 600 MHz UC-2104-LX: Armv7 Cortex-A8 600 MHz UC-2111-LX: Armv7 Cortex-A8 600 MHz UC-2112-LX: Armv7 Cortex-A8 1 GHz UC-2112-T-LX: Armv7 Cortex-A8 1 GHz
DRAM	UC-2101-LX: 256 MB DDR3 UC-2102-LX: 256 MB DDR3 UC-2104-LX: 256 MB DDR3 UC-2111-LX: 512 MB DDR3 UC-2112-LX: 512 MB DDR3 UC-2112-T-LX: 512 MB DDR3
Pre-installed OS	Moxa Industrial Linux (Debian 9, Kernel 4.4) See www.moxa.com/MIL

Storage Pre-installed	8 GB eMMC
Storage Slot	UC-2111-LX: Micro SD slots x 1 UC-2112-LX: Micro SD slots x 1 UC-2112-T-LX: Micro SD slots x 1

Computer Interface

Ethernet Ports	UC-2101-LX: Auto-sensing 10/100 Mbps ports (RJ45 connector) x 1 UC-2102-LX: Auto-sensing 10/100 Mbps ports (RJ45 connector) x 2 UC-2104-LX: Auto-sensing 10/100 Mbps ports (RJ45 connector) x 1 UC-2111-LX: Auto-sensing 10/100 Mbps ports (RJ45 connector) x 2 UC-2112-LX: Auto-sensing 10/100 Mbps ports (RJ45 connector) x 1, Auto-sensing 10/100/1000 Mbps ports (RJ45 connector) x 1 UC-2112-T-LX: Auto-sensing 10/100 Mbps ports (RJ45 connector) x 1, Auto-sensing 10/100/1000 Mbps ports (RJ45 connector) x 1
Serial Ports	UC-2101-LX: RS-232/422/485 ports x 1, software selectable (DB9 male) UC-2111-LX: RS-232/422/485 ports x 2, software selectable (DB9 male) UC-2112-LX: RS-232/422/485 ports x 2, software selectable (DB9 male) UC-2112-T-LX: RS-232/422/485 ports x 2, software selectable (DB9 male)
Console Port	RS-232 (TxD, RxD, GND), 4-pin header output (115200, n, 8, 1)
Expansion Slots	UC-2104-LX: mPCIe slot x 1
Cellular Antenna Connector	UC-2104-LX: SMA x 2
Number of SIMs	UC-2104-LX: 1
SIM Format	UC-2104-LX: Standard
Buttons	Reset button, DIP switch for serial port configuration

Ethernet Interface

Magnetic Isolation Protection	1.5 kV (built-in)
-------------------------------	-------------------

Serial Interface

Data Bits	5, 6, 7, 8
Stop Bits	1, 1.5, 2
Parity	None, Even, Odd, Space, Mark
Flow Control	RTS/CTS, XON/XOFF, ADDC® (automatic data direction control) for RS-485, RTS Toggle (RS-232 only)
Baudrate	50 bps to 921.6 kbps
Pull High/Low Resistor for RS-485	1 kilo-ohm, 150 kilo-ohms
ESD Protection	4 kV, for all signals

Serial Signals

RS-232	TxD, RxD, RTS, CTS, DTR, DSR, DCD, GND
RS-422	Tx+, Tx-, Rx+, Rx-, GND
RS-485-4w	Tx+, Tx-, Rx+, Rx-, GND
RS-485-2w	Data+, Data-, GND

LED Indicators

System	Power x 1
LAN	2 per port (10/100 Mbps)

	UC-2112-LX, UC-2112-T-LX: 2 per port (10/100/1000 Mbps)
Serial	UC-2101-LX: 2 per port (Tx, Rx) UC-2111-LX: 2 per port (Tx, Rx) UC-2112-LX: 2 per port (Tx, Rx) UC-2112-T-LX: 2 per port (Tx, Rx)
User Programmable	UC-2101-LX: User x 1 UC-2102-LX: User x 2 UC-2111-LX: User x 1 UC-2112-LX: User x 1 UC-2112-T-LX: User x 1
Wireless Signal Strength	UC-2104-LX: Cellular/Wi-Fi x 3

Physical Characteristics

Housing	Metal
Installation	Wall mounting, DIN-rail mounting (with optional kit)
Weight	UC-2101-LX: 190 g (0.42 lb) UC-2102-LX: 190 g (0.42 lb) UC-2104-LX: 220 g (0.49 lb) UC-2111-LX: 290 g (0.64 lb) UC-2112-LX: 290 g (0.64 lb) UC-2112-T-LX: 290 g (0.64 lb)
Dimensions (with ears)	UC-2101-LX: 73 x 80 x 28 mm (2.87 x 3.15 x 1.10 in) UC-2102-LX: 73 x 80 x 28 mm (2.87 x 3.15 x 1.10 in) UC-2104-LX: 80 x 80 x 30.8 mm (3.15 x 3.15 x 1.21 in) UC-2111-LX: 99 x 111 x 25.5 mm (3.90 x 4.37 x 1.00 in) UC-2112-LX: 99 x 111 x 25.5 mm (3.90 x 4.37 x 1.00 in) UC-2112-T-LX: 99 x 111 x 25.5 mm (3.90 x 4.37 x 1.00 in)
Dimensions (without ears)	UC-2101-LX: 50 x 80 x 28 mm (1.97 x 3.15 x 1.10 in) UC-2102-LX: 50 x 80 x 28 mm (1.97 x 3.15 x 1.10 in) UC-2104-LX: 57 x 80 x 30.8 mm (2.24 x 3.15 x 1.21 in) UC-2111-LX: 77 x 111 x 25.5 mm (3.03 x 4.37 x 1.00 in) UC-2112-LX: 77 x 111 x 25.5 mm (3.03 x 4.37 x 1.00 in) UC-2112-T-LX: 77 x 111 x 25.5 mm (3.03 x 4.37 x 1.00 in)

Environmental Limits

Operating Temperature	UC-2101-LX: -10 to 60°C (14 to 140°F) UC-2102-LX: -10 to 60°C (14 to 140°F) UC-2104-LX: -10 to 70°C (14 to 158°F) UC-2111-LX: -10 to 60°C (14 to 140°F) UC-2112-LX: -10 to 60°C (14 to 140°F) UC-2112-T-LX: -40 to 75°C (-40 to 167°F)
Storage Temperature	UC-2101-LX: -20 to 70°C (-4 to 158°F) UC-2102-LX: -20 to 70°C (-4 to 158°F) UC-2104-LX: -20 to 70°C (-4 to 158°F) UC-2111-LX: -20 to 70°C (-4 to 158°F) UC-2112-LX: -20 to 70°C (-4 to 158°F) UC-2112-T-LX: -40 to 85°C (-40 to 185°F)
Ambient Relative Humidity	5 to 95% (non-condensing)
Shock	IEC 60068-2-27
Vibration	2 Grms @ IEC 60068-2-64, random wave, 5-500 Hz, 1 hr per axis (without USB devices attached)

Power Parameters

Input Voltage	9 to 48 VDC
Input Current	0.45 A @ 9 VDC, 0.084 A @ 48 VDC
Power Consumption	4 W

MTBF

Time	UC-2101-LX: 1,360,496 hrs UC-2102-LX: 1,652,339 hrs UC-2104-LX: 1,577,995 hrs UC-2111-LX: 985,911 hrs UC-2112-LX: 982,882 hrs UC-2112-T-LX: 982,882 hrs
Standards	Telcordia (Bellcore) Standard TR/SR

Reliability

Alert Tools	External RTC (real-time clock)
Automatic Reboot Trigger	External WDT (watchdog timer)

Standards and Certifications

Safety	IEC 60950-1, UL 60950-1
EMC	EN 55032/24
EMI	CISPR 32, FCC Part 15B Class A
EMS	IEC 61000-4-2 ESD: Contact: 4 kV; Air: 8 kV IEC 61000-4-3 RS: 80 MHz to 1 GHz: 3 V/m IEC 61000-4-4 EFT: Power: 1 kV; Signal: 0.5 kV IEC 61000-4-5 Surge: Power: 0.5 kV; Signal: 1 kV IEC 61000-4-6 CS: 3 V IEC 61000-4-8 PFMF
Hazardous Locations	UC-2112-LX, UC-2112-T-LX: Class I Division 2, ATEX Zone 2
Green Product	RoHS, CRoHS, WEEE

Warranty

Warranty Period	5 years
Details	See www.moxa.com/warranty

Package Contents

Device	1 x UC-2100 Series computer
Installation Kit	1 x power jack
Cable	1 x console cable
Documentation	1 x quick installation guide 1 x warranty card

Dimensions

UC-2101

Unit: mm (inch)

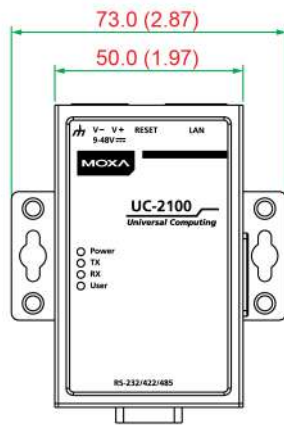
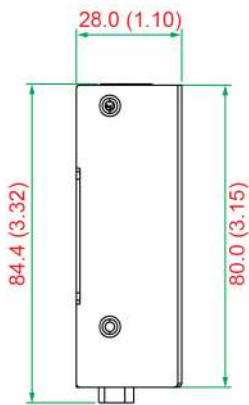

UC-2111

Unit: mm (inch)

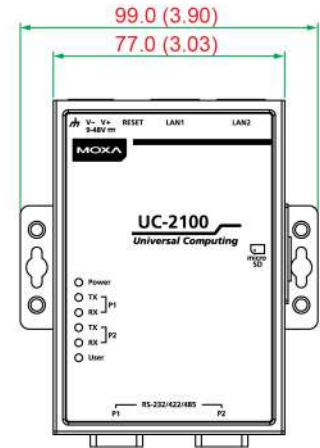
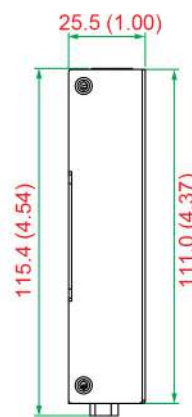

UC-2102

Unit: mm (inch)

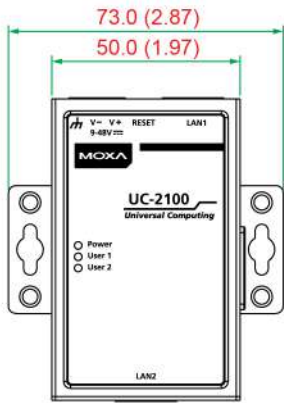
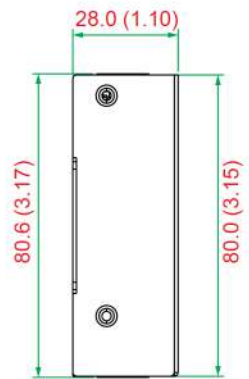

UC-2112

Unit: mm (inch)

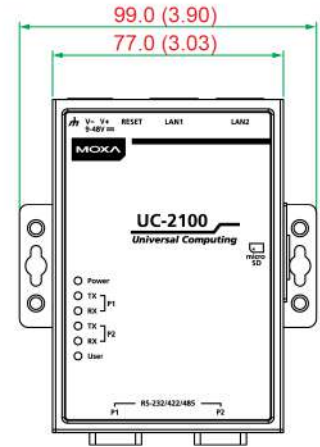
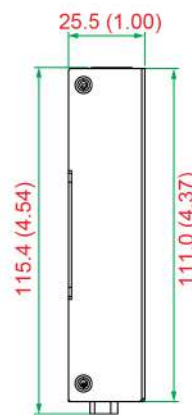

UC-2104

Unit: mm (inch)

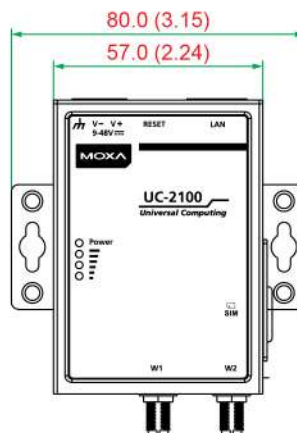
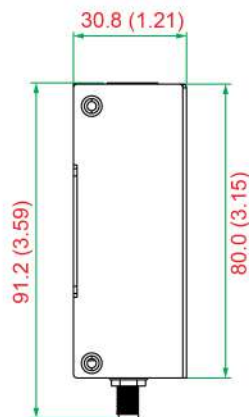

Ordering Information

Model Name	CPU	RAM	Storage	Serial	Ethernet	MicroSD	Mini PCIe	Operating Temp.
UC-2101-LX	600 MHz	256 MB	8 GB	1	1	-	-	-10 to 60°C
UC-2102-LX	600 MHz	256 MB	8 GB	-	2	-	-	-10 to 60°C

Model Name	CPU	RAM	Storage	Serial	Ethernet	MicroSD	Mini PCIe	Operating Temp.
UC-2104-LX	600 MHz	256 MB	8 GB	–	1	–	1	-10 to 60°C
UC-2111-LX	600 MHz	512 MB	8 GB	2	2	1	–	-10 to 60°C
UC-2112-LX	1000 MHz	512 MB	8 GB	2	2 (1 Giga LAN)	1	–	-10 to 60°C
UC-2112-T-LX	1000 MHz	512 MB	8 GB	2	2 (1 Giga LAN)	1	–	-40 to 75°C

Accessories (sold separately)

Power Adapters

PWR-12150-USJP-SA-T	Locking barrel plug, 12 VDC 1.5 A, 100 to 240 VAC, US/JP plug, -40 to 75°C operating temperature
PWR-12150-EU-SA-T	Locking barrel plug, 12 VDC, 1.5 A, 100 to 240 VAC, EU plug, -40 to 75°C operating temperature
PWR-12150-UK-SA-T	Locking barrel plug, 12 VDC, 1.5 A, 100 to 240 VAC, UK plug, -40 to 75°C operating temperature
PWR-12150-AU-SA-T	Locking barrel plug, 12 VDC, 1.5 A, 100 to 240 VAC, AU plug, -40 to 75°C operating temperature
PWR-12150-CN-SA-T	Locking barrel plug, 12 VDC, 1.5 A, 100 to 240 VAC, CN plug, -40 to 75°C operating temperature

Cellular Wireless Modules

UC-LTE-CAT1-AP	LTE cellular module with 2 M2 and 2 M2.5 mounting screws for Asia-Pacific bands 1, 3, 5, 8, 9, 18(26), 19, 28
UC-LTE-CAT1-EU	LTE cellular module with 2 M2 and 2 M2.5 mounting screws for EMEA bands 1, 3, 7, 8, 20, 28A

Wi-Fi Wireless Modules

UC-WiFi-USB	802.11 a/b/g/n/ac, 2.4/5 GHz Wi-Fi module with 2 each of M2 and M2.5 screws
-------------	---

Antennas

ANT-WDB-ARM-0202 plus ADP	2.4/5 GHz omni-directional antenna, 2/2 dBi, RP-SMA-type (male) connector
ANT-LTE-OSM-03-3m BK	700-2700 MHz, multiband antenna, specifically designed for 2G, 3G, and 4G applications, 3 m cable
ANT-LTE-ASM-04 BK	704 to 960/1710 to 2620 MHz, LTE omnidirectional stick antenna, 4.5 dBi
ANT-LTE-ASM-05 BK	704-960/1710-2620 MHz, LTE stick antenna, 5 dBi
ANT-LTE-OSM-06-3m BK MIMO	Multiband antenna with screw-fastened mounting option for 700-2700/2400-2500/5150-5850 MHz frequencies
A-ADP-SM-RF Golden	SMA adapter for UC-2104 and UC-5100 Series
ANT-LTEUS-ASM-01	GSM/GPRS/EDGE/UMTS/HSPA/LTE, 1 dBi, omnidirectional rubber-duck antenna

DIN-Rail Mounting Kits

DK35A	DIN-rail mounting kit, 35 mm
-------	------------------------------

© Moxa Inc. All rights reserved. Updated Jan 20, 2022.

This document and any portion thereof may not be reproduced or used in any manner whatsoever without the express written permission of Moxa Inc. Product specifications subject to change without notice. Visit our website for the most up-to-date product information.