

# 97×33 mm

## San Ace B97 9BMB type



### General Specifications

- Material ..... Frame: Plastic (Flammability: UL 94V-0), Impeller: Plastic (Flammability: UL 94V-0)
- Expected life ..... See the table below. (L10 life: 90% survival rate for continuous operation in free air at 60°C, rated voltage) Expected life at 40°C is for reference only.
- Motor protection function ..... Locked rotor burnout protection, Reverse polarity protection  
For details, please refer to p. 580.
- Dielectric strength ..... 50/60 Hz, 500 VAC, for 1 minute (between lead wire conductors and frame)
- Insulation resistance ..... 10 MΩ min. at 500 VDC (between lead wire conductors and frame)
- Sound pressure level (SPL) ..... A-weighted sound pressure level (SPL) at 1 m away from the air inlet.
- Storage temperature ..... -30 to +70°C (Non-condensing)
- Lead wire ..... ⊕Red ⊖Black (Sensor) Yellow (Control) Brown  
(For models without PWM control function, there is no speed control wiring.)
- Mass ..... 190 g

### Specifications

The models listed below **have pulse sensors with PWM control function.**

Model no.	Rated voltage [V]	Operating voltage range [V]	PWM duty cycle [%]	Rated current [A]	Rated input [W]	Rated speed [min <sup>-1</sup> ]	Max. airflow [m <sup>3</sup> /min] [CFM]	Max. static pressure [Pa] [inchH <sub>2</sub> O]	SPL [dB (A)]	Operating temperature [°C]	Expected life [h]
9BMB12P2K01	12	10.8 to 13.2	100	3.4	40.8	6850	1.61 56.8	1280 5.14	66	-20 to +70	40000/60°C (70000/40°C)
9BMB12P2G01			100	1.8	21.6	5750	1.34 47.3	760 3.05	61		
9BMB12P2S01		10.2 to 13.8	100	1.4	16.8	5250	1.22 43.1	610 2.45	59		
9BMB12P2H01			100	1.1	13.2	4850	1.11 39.2	490 1.968	57		
9BMB12P2F01	24	21.6 to 26.4	100	0.9	10.8	4500	1.04 36.7	410 1.64	56		
9BMB24P2K01			100	1.62	38.88	6850	1.61 56.8	1280 5.14	66		
9BMB24P2G01			100	0.83	19.92	5750	1.34 47.3	760 3.05	61		
9BMB24P2S01			100	0.7	16.8	5250	1.22 43.1	610 2.45	59		
9BMB24P2H01			100	0.55	13.2	4850	1.11 39.2	490 1.968	57		
9BMB24P2F01			100	0.45	10.8	4500	1.04 36.7	410 1.64	56		

\* PWM frequency is 25 kHz. Models without ratings for 0% PWM duty cycle have zero speed at 0%. When control terminal is open, speed is the same as at 100% duty cycle.

The models listed below **have pulse sensors.**

Model no.	Rated voltage [V]	Operating voltage range [V]	Rated current [A]	Rated input [W]	Rated speed [min <sup>-1</sup> ]	Max. airflow [m <sup>3</sup> /min] [CFM]	Max. static pressure [Pa] [inchH <sub>2</sub> O]	SPL [dB (A)]	Operating temperature [°C]	Expected life [h]	
9BMB12K201	12	7 to 13.2	3.4	40.8	6850	1.61 56.8	1280 5.14	66	-20 to +70	40000/60°C (70000/40°C)	
9BMB12G201			1.8	21.6	5750	1.34 47.3	760 3.052	61			
9BMB12S201			7 to 13.8	1.4	16.8	5250	1.22 43.1	610 2.45			59
9BMB12H201				1.1	13.2	4850	1.11 39.2	490 1.968			57
9BMB12F201				0.9	10.8	4500	1.04 36.7	410 1.647			56
9BMB24K201	24	12 to 26.4	1.62	38.88	6850	1.61 56.8	1280 5.14	66			
9BMB24G201			0.83	19.9	5750	1.34 47.3	760 3.052	61			
9BMB24S201			0.7	16.8	5250	1.22 43.1	610 2.45	59			
9BMB24H201			0.55	13.2	4850	1.11 39.2	490 1.968	57			
9BMB24F201			0.45	10.8	4500	1.04 36.7	410 1.647	56			

Note 1: Sensor and control options are available for selection. Refer to the table on p. 604.

Note 2: The mark indicates Short Lead Time Service applicable models. See p. 630 for details.

# Airflow - Static Pressure Characteristics / PWM Duty - Speed Characteristics Example

## 9BMB12P2K01 With pulse sensor with PWM control function

PWM duty cycle

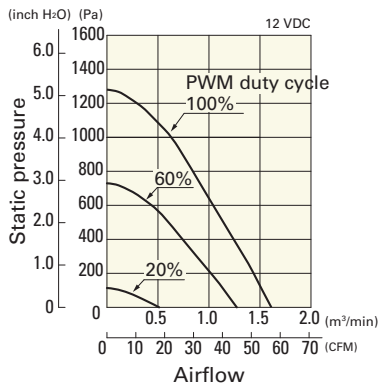

Operating voltage range

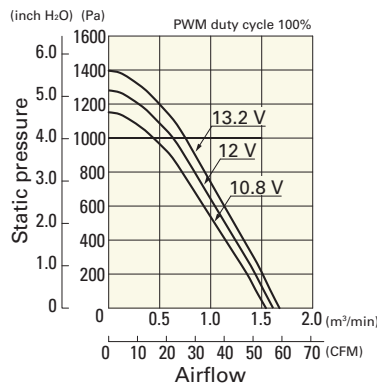

PWM duty - Speed characteristics example

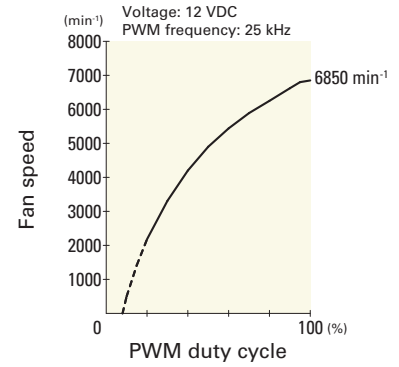

## 9BMB12P2G01 With pulse sensor with PWM control function

PWM duty cycle

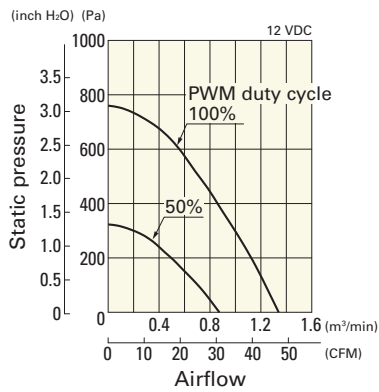

Operating voltage range

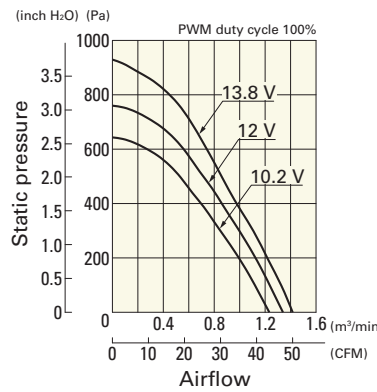

PWM duty - Speed characteristics example

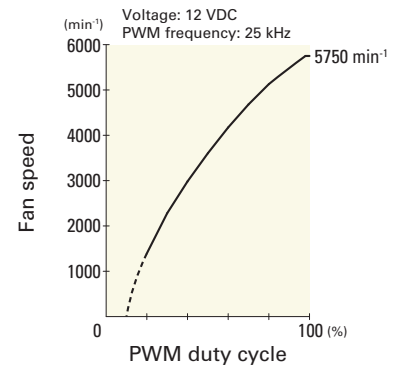

## 9BMB12P2S01 With pulse sensor with PWM control function

PWM duty cycle

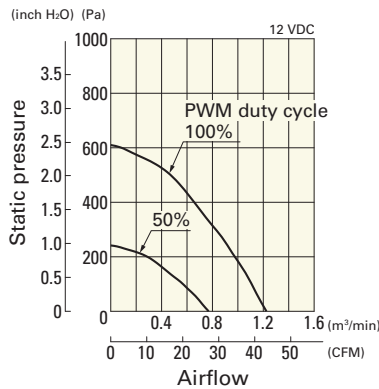

Operating voltage range

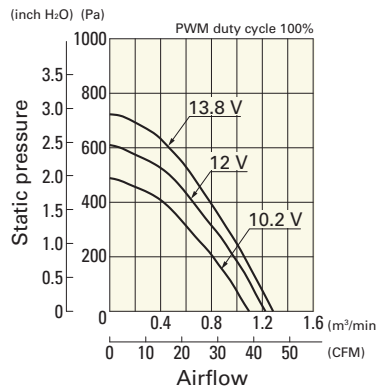

PWM duty - Speed characteristics example

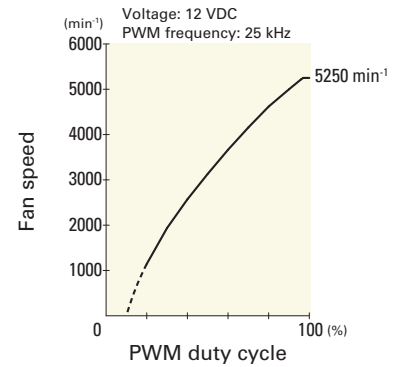

## 9BMB12P2H01 With pulse sensor with PWM control function

PWM duty cycle

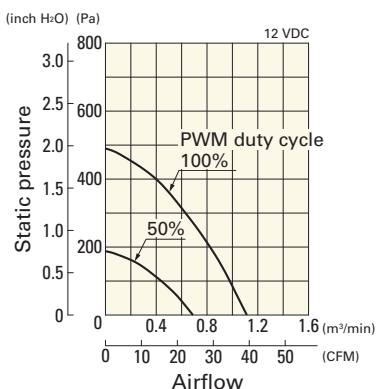

Operating voltage range

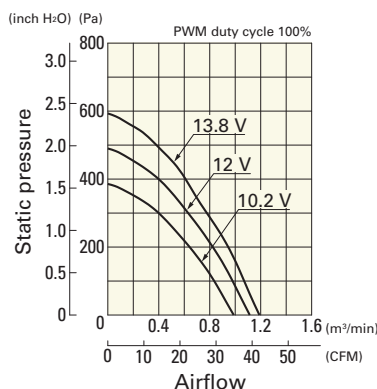

PWM duty - Speed characteristics example

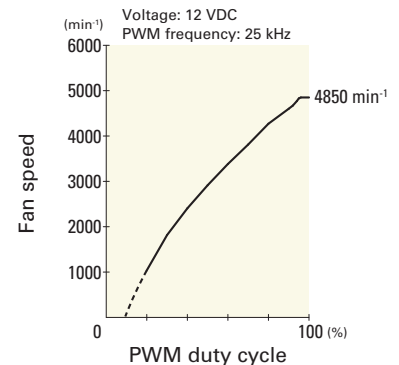

Blower 97 mm DC

# Airflow - Static Pressure Characteristics / PWM Duty - Speed Characteristics Example

**9BMB12P2F01** With pulse sensor with PWM control function

PWM duty cycle

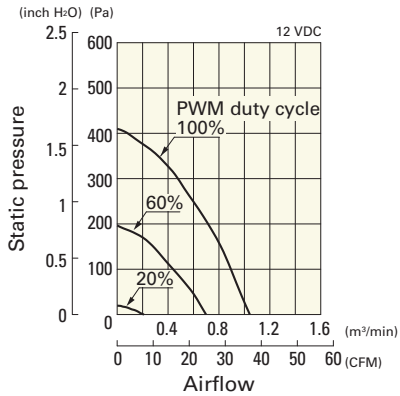

Operating voltage range

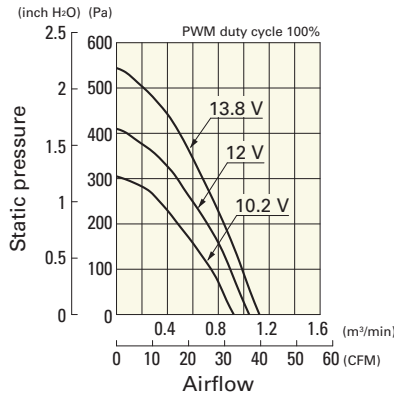

PWM duty - Speed characteristics example

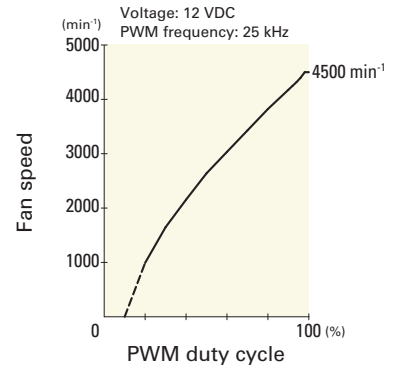

**9BMB24P2K01** With pulse sensor with PWM control function

PWM duty cycle

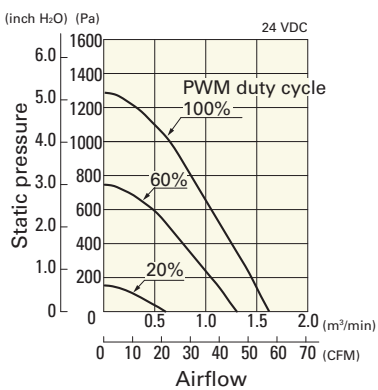

Operating voltage range

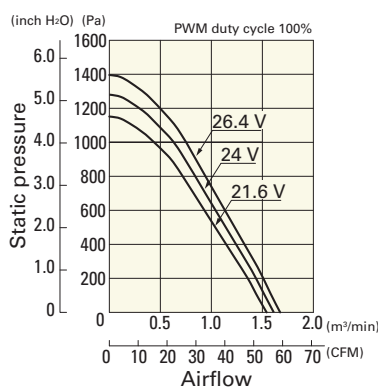

PWM duty - Speed characteristics example

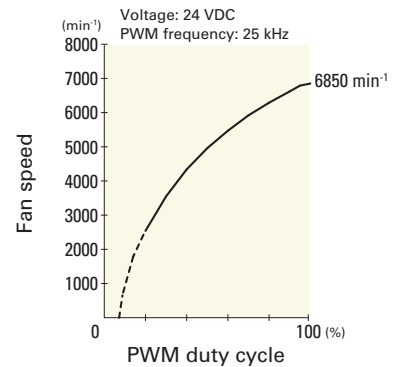

**9BMB24P2G01** With pulse sensor with PWM control function

PWM duty cycle

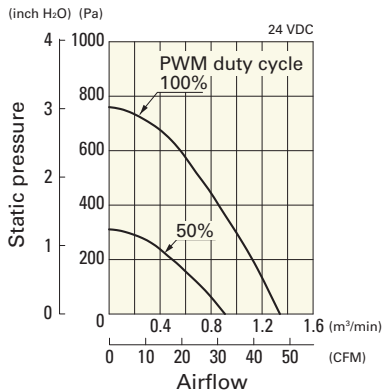

Operating voltage range

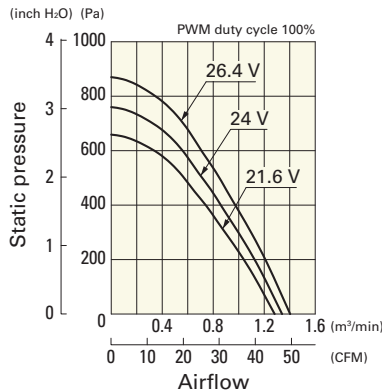

PWM duty - Speed characteristics example

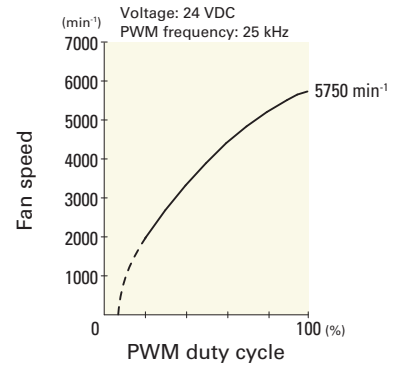

**9BMB24P2S01** With pulse sensor with PWM control function

PWM duty cycle

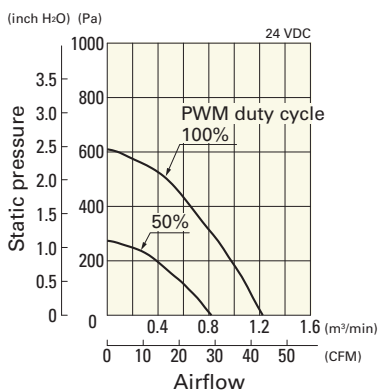

Operating voltage range

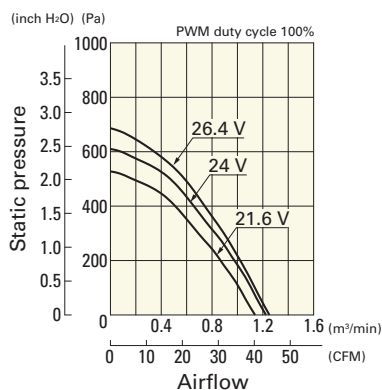

PWM duty - Speed characteristics example

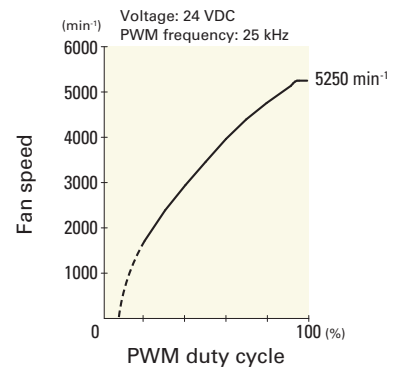

Blower 97 mm DC

## Airflow - Static Pressure Characteristics / PWM Duty - Speed Characteristics Example

**9BMB24P2H01** With pulse sensor with PWM control function

PWM duty cycle

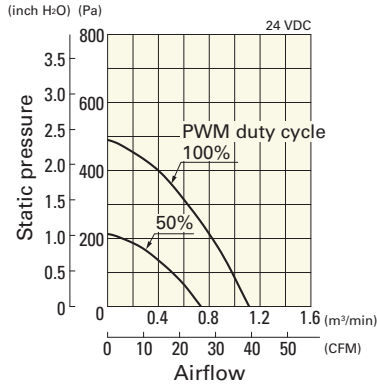

Operating voltage range

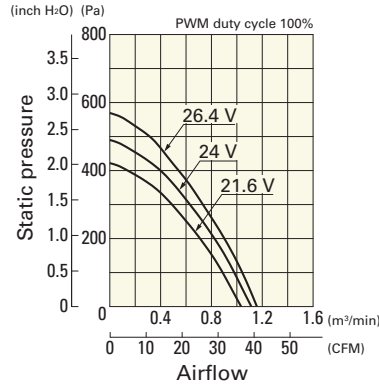

PWM duty - Speed characteristics example

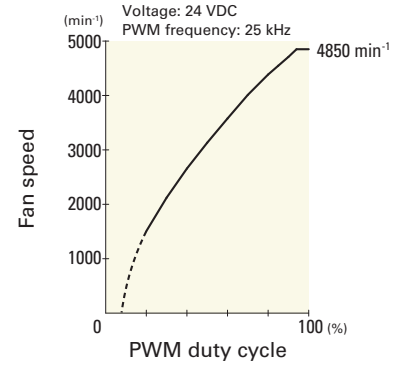

**9BMB24P2F01** With pulse sensor with PWM control function

PWM duty cycle

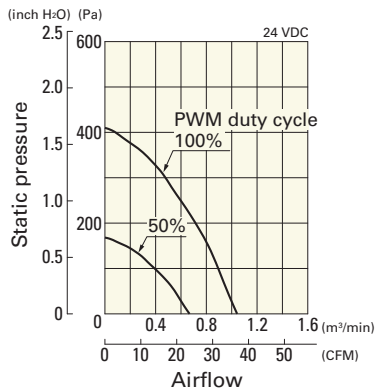

Operating voltage range

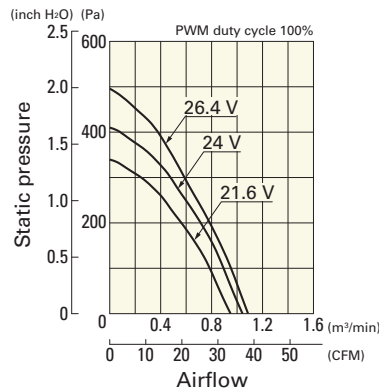

PWM duty - Speed characteristics example

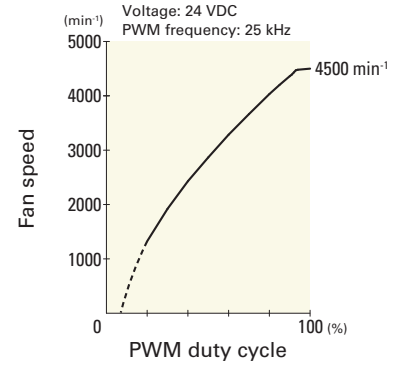

## Airflow - Static Pressure Characteristics

**9BMB12K201** With pulse sensor

Operating voltage range

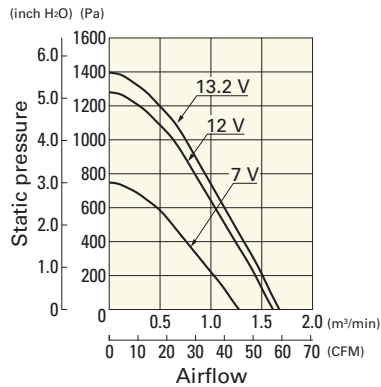

**9BMB12G201** With pulse sensor

Operating voltage range

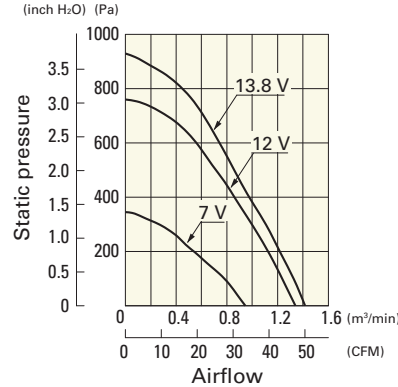

**9BMB12S201** With pulse sensor

Operating voltage range

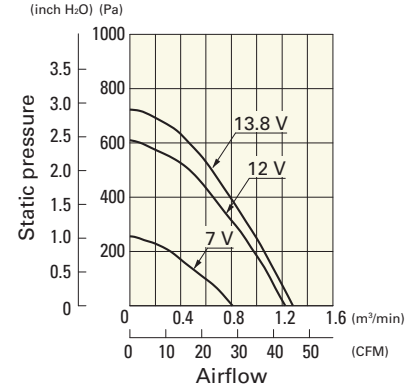

## Airflow - Static Pressure Characteristics

### 9BMB12H201 With pulse sensor

Operating voltage range

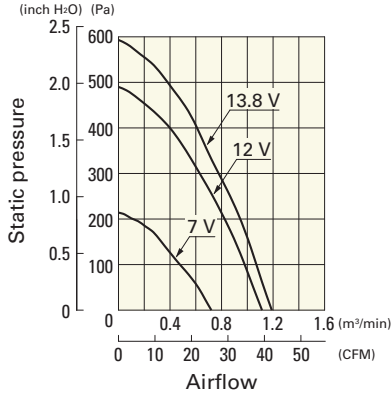

### 9BMB12F201 With pulse sensor

Operating voltage range

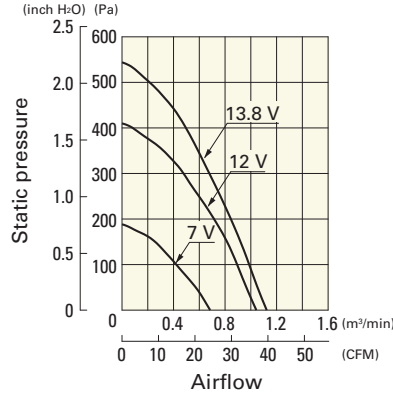

### 9BMB24K201 With pulse sensor

Operating voltage range

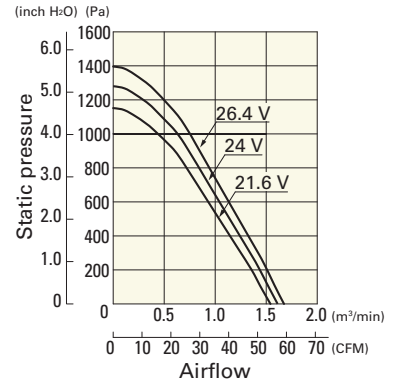

### 9BMB24G201 With pulse sensor

Operating voltage range

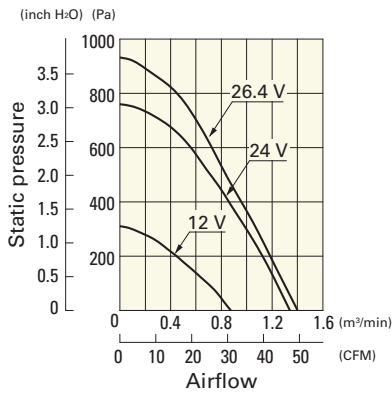

### 9BMB24S201 With pulse sensor

Operating voltage range

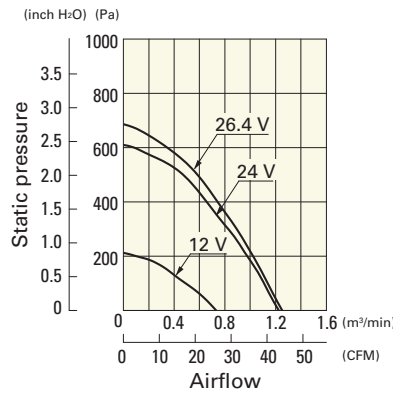

### 9BMB24H201 With pulse sensor

Operating voltage range

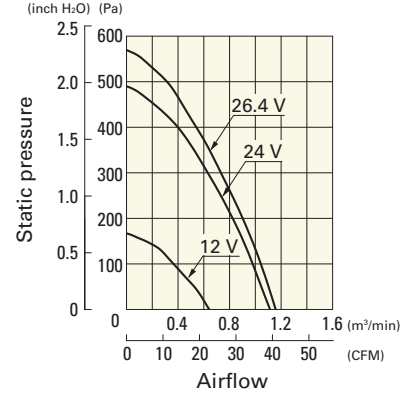

### 9BMB24F201 With pulse sensor

Operating voltage range

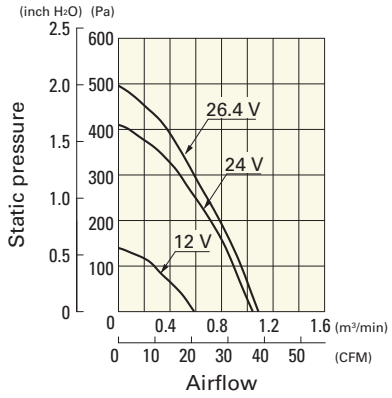

Blower 97 mm DC

**Dimensions (unit: mm)** (With pulse sensor with PWM control function)

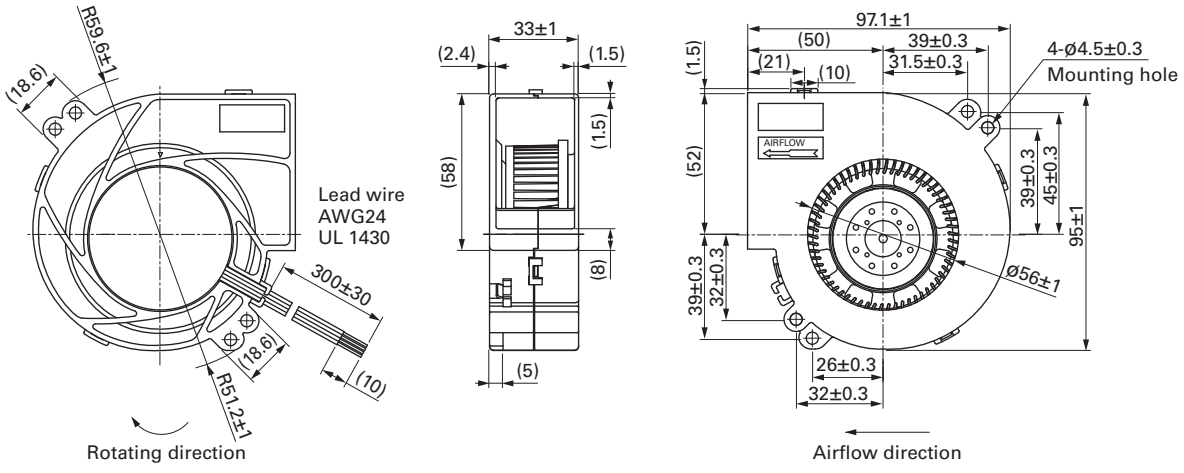

Blower 97 mm DC